

N° d'ordre 3142

THÈSE

présentée à

L'UNIVERSITÉ DE BORDEAUX I

ÉCOLE DOCTORALE DE MATHÉMATIQUES ET INFORMATIQUE

par **Francis BROWN**

POUR OBTENIR LE GRADE DE

DOCTEUR

SPÉCIALITÉ: **Mathématiques Pures**

PÉRIODES DES ESPACES DES MODULES $\mathfrak{M}_{0,n}$ ET VALEURS ZÊTAS MULTIPLES.

Soutenue le mardi 7 mars 2006

Après avis de:

P. CARTIER , Professeur, IHÉS et Directeur de Recherches, CNRS
R. M. HAIN , Professor, Duke University

Devant la commission d'examen formée de:

P. CARTIER , Professeur, IHÉS et Directeur de Recherches, CNRS
P. CASSOU-NOGUES , Professeur, Université de Bordeaux I
B. EREZ , Professeur, Université de Bordeaux I
P. LOCHAK , Chargé de Recherches, CNRS
J-P. RAMIS , Professeur, Université de Toulouse III
L. SCHNEPS , Directeur de Recherches, CNRS

REMERCIEMENTS

Je tiens tout d’abord à remercier mon directeur de thèse, Boas Erez, de m’avoir encadré durant ces trois dernières années, et de m’avoir parlé de la conjecture de Zagier sur les régulateurs et polylogarithmes, qui reste, pour moi, une source d’inspiration (et un rêve lointain). Je le remercie aussi de m’avoir proposé d’étudier les intégrales de Rhin et Viola comme “tâche de fond”, tout au début de ma thèse. C’est en essayant de comprendre leurs résultats que l’idée de ce projet est née.

J’adresse ma gratitude à Pierre Cartier, Phillippe Cassou-Noguès, Pierre Lochak, Jean-Pierre Ramis et Leila Schneps, qui m’ont fait l’honneur de participer à mon jury. Plus particulièrement, je remercie Pierre Cartier, Pierre Lochak, Jean-Pierre Ramis et Leila Schneps qui sont venus de loin pour ma soutenance de thèse.

Je voudrais remercier Richard Hain, très chaleureusement, pour la lecture très soignée de ce travail, et pour ses remarques profondes et détaillées qui ont apporté de nombreuses améliorations à ce texte. En outre, l’ensemble de ses remarques m’a permis d’acquérir une meilleure vision sur un certain nombre de questions techniques.

Ma gratitude va également à tous les membres du groupe de travail de Chevaleret sur les polylogarithmes et les valeurs zêtas multiples. Les encouragements de Louis Boutet de Monvel, Joseph Oesterlé, Michel Waldschmidt, et Pierre Cartier, lors de mes premiers pas dans ce domaine, m’ont été très précieux. Plus récemment, j’ai particulièrement apprécié les contacts scientifiques et humains avec Pierre, Leila, Sarah et Ishmael, avec qui je partage un même enthousiasme pour ce domaine.

J’ai été largement inspiré par les travaux du groupe Lillois sur les polylogarithmes, et notamment Hoang Minh et Michel Petitot. L’influence de leur approche pour le calcul de la monodromie se voit clairement au paragraphe §6.5 de ma thèse. J’ai également bénéficié de plusieurs discussions avec Stéphane Fischler sur les intégrales multiples. Ma reconnaissance va, par ailleurs, à Herbert Gangl pour ses encouragements et sa gentillesse. C’est à lui que je dois la remarque cruciale qu’il faut considérer les polylogarithmes multiples à plusieurs variables, si l’on veut réaliser la cohomologie motivique toute entière. C’est cette même remarque qui m’a donné le courage de passer de $\mathbb{P}^1 \setminus \{0, 1, \infty\}$ aux espaces de modules $\mathfrak{M}_{0,n}$.

Finalement, mes remerciements les plus vifs s’adressent à Pierre Cartier. Je lui suis profondément reconnaissant de la patience et de la générosité qu’il a manifestées, lors des ses vendredis après-midi à l’IHES, au cours desquels il m’a expliqué beaucoup de mathématiques. Ses nombreux centres d’intérêts, et ses connaissances encyclopédiques ne cesseront de m’étonner! Dans ce travail, je lui dois de nombreuses suggestions et simplifications. Je le remercie aussi pour l’intérêt qu’il m’a manifesté, et pour ses relectures attentives. Sans son soutien, ses encouragements et sa bonne humeur, ce travail n’aurait certainement pas abouti sous sa forme actuelle.

Géométrie algébrique

Périodes des espaces des modules $\overline{\mathcal{M}}_{0,n}$ et valeurs zêtas multiples

Francis C.S. Brown

A2X, 351, cours de la Libération, 33405 Talence cedex, France

Reçu le 20 février 2006 ; accepté le 18 avril 2006

Disponible sur Internet le 15 mai 2006

Présenté par Christophe Soulé

Résumé

Nous donnons les grandes lignes d'une démonstration de la conjecture de Goncharov et Manin qui prédit que les périodes relatives des espaces des modules $\mathcal{M}_{0,n}$ des courbes de genre 0 avec n points marqués sont des valeurs zêtas multiples. *Pour citer cet article : F.C.S. Brown, C. R. Acad. Sci. Paris, Ser. I 342 (2006).*

© 2006 Académie des sciences. Publié par Elsevier SAS. Tous droits réservés.

Abstract

Multiple zeta values and periods of moduli spaces $\overline{\mathcal{M}}_{0,n}$. We sketch a proof of the conjecture due to Goncharov and Manin which states that the relative periods of the moduli space $\mathcal{M}_{0,n}$ of Riemann spheres with n ordered marked points are multiple zeta values. *To cite this article: F.C.S. Brown, C. R. Acad. Sci. Paris, Ser. I 342 (2006).*

© 2006 Académie des sciences. Publié par Elsevier SAS. Tous droits réservés.

Abridged English version

Let $n = \ell + 3 \geq 4$, and let $\mathcal{M}_{0,n}$ denote the moduli space of curves of genus 0 with n marked points. There is a smooth compactification $\overline{\mathcal{M}}_{0,n}$, defined by Deligne, Knudsen and Mumford, such that the complement $\overline{\mathcal{M}}_{0,n} \setminus \mathcal{M}_{0,n}$ is a normal crossing divisor. Let $A, B \subset \overline{\mathcal{M}}_{0,n} \setminus \mathcal{M}_{0,n}$ denote two sets of boundary divisors which share no irreducible components. In [8], Goncharov and Manin show that the relative cohomology group $H^\ell(\overline{\mathcal{M}}_{0,n} \setminus A, B \setminus B \cap A)$ defines a mixed Tate motive unramified over \mathbb{Z} .

Now let $n_1, \dots, n_r \in \mathbb{N}$, and suppose that $n_r \geq 2$. The multiple zeta value $\zeta(n_1, \dots, n_r)$ is

$$\zeta(n_1, \dots, n_r) = \sum_{0 < k_1 < \dots < k_r} \frac{1}{k_1^{n_1} \dots k_r^{n_r}}. \quad (1)$$

Its weight is the quantity $n_1 + \dots + n_r$, and its depth is the number of indices r . A very general conjecture [7] claims that the periods of any mixed Tate motive unramified over \mathbb{Z} are multiple zeta values. In the case of motives arising from moduli spaces $\mathcal{M}_{0,n}$, this says the following. Consider a smooth compact real submanifold $X_B \subset \overline{\mathcal{M}}_{0,n} \setminus A$, whose boundary is contained in B , and let $\omega_A \in \Omega^\ell(\overline{\mathcal{M}}_{0,n} \setminus A)$ denote an algebraic form defined over \mathbb{Q} , with singularities contained in A . In [8], Goncharov and Manin conjecture that the integral

Adresse e-mail : brown@clipper.ens.fr (F.C.S. Brown).

$$I = \int_{X_B} \omega_A \tag{2}$$

is a rational linear combination of multiple zeta values and the constants $(2i\pi)^k$, which are of weight k .

Theorem 0.1. [1] *The integral I is a $\mathbb{Q}[2i\pi]$ -linear combination of multiple zeta values of weight $\leq \ell$.*

This lends significant weight to the conjecture on the periods of all mixed Tate motives unramified over \mathbb{Z} . The rough idea of our method is as follows. The set of real points $\mathfrak{M}_{0,n}(\mathbb{R})$ is tessellated by a number of open cells X_n which can naturally be identified with a Stasheff polytope, or associahedron. We can reduce to the case where the domain of integration in (2) is a single cell X_n . The key is then to apply a version of Stokes’s theorem to the closed polytope $\overline{X}_n \subset \overline{\mathfrak{M}}_{0,n}(\mathbb{R})$. Since each face of \overline{X}_n is itself a product of associahedra $\overline{X}_a \times \overline{X}_b$, we repeatedly take primitives to obtain a cascade of integrals over associahedra of smaller and smaller dimension. In order to do this, we need to construct a graded algebra $L(\mathfrak{M}_{0,n})$ of multiple polylogarithm functions on $\mathfrak{M}_{0,n}$ in which primitives exist. At each stage of the induction, the dimension of the domain of integration decreases by one, and the weight of the integrand increases by one. At the final stage we evaluate a multiple polylogarithm at the point 1, and this gives a linear combination of multiple zeta values. This approach for computing periods works in much greater generality, and our results should extend without difficulty to the case of configuration spaces related to Coxeter groups.

1. Introduction

Soient $n_1, \dots, n_r \in \mathbb{N}$, et supposons que $n_r \geq 2$. La valeur zêta multiple $\zeta(n_1, \dots, n_r)$ est la somme

$$\zeta(n_1, \dots, n_r) = \sum_{0 < m_1 < \dots < m_r} \frac{1}{m_1^{n_1} \dots m_r^{n_r}}.$$

Son poids est la quantité $n_1 + \dots + n_r$. Soit \mathcal{Z} le \mathbb{Q} -espace vectoriel engendré par ces nombres. On démontre que \mathcal{Z} est une algèbre filtrée par le poids [14]. Nous dirons que la constante $2i\pi$ est de poids 1.

Soit $n \geq 4$, et soit $\mathfrak{M}_{0,n}$ l’espace des modules des courbes de genre 0 avec n points marqués. Il y a une compactification lisse $\overline{\mathfrak{M}}_{0,n}$ due à Deligne, Knudsen et Mumford [4] telle que $\overline{\mathfrak{M}}_{0,n} \setminus \mathfrak{M}_{0,n}$ soit un diviseur à croisements normaux. Soient $A, B \subset \overline{\mathfrak{M}}_{0,n} \setminus \mathfrak{M}_{0,n}$ deux ensembles de diviseurs qui se rencontrent en codimension 2. Soit $X \subset \overline{\mathfrak{M}}_{0,n} \setminus A$ une sous-variété réelle compacte lisse de dimension ℓ dont le bord est contenu dans B , et soit ω_A une ℓ -forme régulière sur $\mathfrak{M}_{0,n}$ à coefficients dans \mathbb{Q} dont les singularités sont contenues dans A . Le théorème suivant a été conjecturé par Goncharov et Manin [8].

Théorème 1.1. [1] *La période $\int_X \omega_A$ est un élément de l’anneau $\mathcal{Z}[2i\pi]$, de poids au plus $\dim X$.*

Quelques résultats partiels dans cette direction ont été obtenus par Terasoma [13] (voir aussi [12]).

2. Éclatements partiels de l’espace des modules $\mathfrak{M}_{0,n}$, et intégrales des périodes

Soit $n \geq 4$, et soit $S = \{s_1, \dots, s_n\}$ un ensemble à n éléments. Notons $\mathfrak{M}_{0,S}$ l’espace des modules des sphères de Riemann avec n points marqués par les éléments de S . C’est la variété

$$\mathfrak{M}_{0,S} = \{(z_s)_{s \in S} : z_s \in \mathbb{P}^1, \text{ deux à deux distincts}\} / \text{PSL}_2,$$

où PSL_2 agit par transformations homographiques sur \mathbb{P}^1 . C’est une variété affine de dimension $\ell = n - 3$. Une structure diédrale δ sur S est une identification des éléments de S avec les sommets (ou les côtés) d’un n -gone régulier. Notons (S, δ) ce polygone, $D_{(S,\delta)}$ son groupe de symétrie diédrale, et $\chi_{S,\delta}$ l’ensemble de ses cordes. Nous dirons que deux cordes $\{i, j\}, \{k, l\} \in \chi_{S,\delta}$ se croisent si elles possèdent un point d’intersection à l’intérieur de (S, δ) . A chaque corde $\{i, j\} \in \chi_{S,\delta}$ on associe une coordonnée diédrale qui est le birapport (symétrique en i et j) :

$$u_{ij} = [ii + 1 | j + 1j] = \frac{(z_i - z_{j+1})(z_{i+1} - z_j)}{(z_i - z_j)(z_{i+1} - z_{j+1})},$$

où nous identifions l'indice i et le point s_i pour $1 \leq i \leq n$. C'est invariant par l'action de PSL_2 et définit une fonction $u_{ij} : \mathfrak{M}_{0,S} \rightarrow \mathbb{P}^1 \setminus \{0, 1, \infty\}$. On obtient de cette manière un plongement affine :

$$(u_{ij})_{\{i,j\} \in \chi_{S,\delta}} : \mathfrak{M}_{0,S} \longrightarrow \mathbb{A}^{n(n-3)/2}.$$

Notons $\mathfrak{M}_{0,S}^\delta$ la clôture de Zariski de son image. Nous démontrons dans [1] que c'est un schéma lisse défini sur \mathbb{Z} , et que l'on a une inclusion $\mathfrak{M}_{0,S} \subset \mathfrak{M}_{0,S}^\delta \subset \overline{\mathfrak{M}}_{0,S}$. Le complémentaire $\mathfrak{M}_{0,S}^\delta \setminus \mathfrak{M}_{0,S}$ est un diviseur à croisements normaux, dont les composantes irréductibles sont les $D_{ij} = \{u_{ij} = 0\}$ où $\{i, j\} \in \chi_{S,\delta}$.

2.1. Points réels et associaèdres

Considérons l'ensemble des points réels $\mathfrak{M}_{0,S}(\mathbb{R})$. A chaque structure diédrale δ on associe une cellule

$$X_{S,\delta} = \{0 < u_{ij} < 1 : \text{pour tout } \{i, j\} \in \chi_{S,\delta}\} \subset \mathfrak{M}_{0,S}(\mathbb{R}).$$

C'est une composante connexe contractile de $\mathfrak{M}_{0,S}(\mathbb{R})$. L'ensemble des $X_{S,\delta}$ lorsque δ parcourt l'ensemble des $n!/2n$ structures diédrales sur S donnent un pavage de la variété réelle $\mathfrak{M}_{0,S}(\mathbb{R})$. La cellule fermée

$$\overline{X}_{S,\delta} = \{0 \leq u_{ij} \leq 1 : \text{pour tout } \{i, j\} \in \chi_{S,\delta}\} \subset \mathfrak{M}_{0,S}^\delta(\mathbb{R}),$$

est une variété à coins, et c'est un modèle algébrique de l'associaèdre ou polyèdre de Stasheff. Ses facettes $F_{ij} = \overline{X}_{S,\delta} \cap \{u_{ij} = 0\}$ sont indexées par les cordes $\{i, j\} \in \chi_{S,\delta}$, et deux faces F_{ij} et F_{kl} se rencontrent si et seulement si $\{i, j\}$ et $\{k, l\}$ ne se croisent pas. Si l'on coupe le polygone (S, δ) le long d'une corde $\{i, j\}$, il se décompose en deux sous-polygones (S_1, δ_1) et (S_2, δ) avec $r + 1$ et $n - r + 1$ côtés. On peut déduire directement des coordonnées diédrales qu'il y a une décomposition des diviseurs et des facettes :

$$D_{ij} \cong \mathfrak{M}_{0,S_1}^{\delta_1} \times \mathfrak{M}_{0,S_2}^{\delta_2}, \quad \text{ce qui implique que } F_{ij} \cong \overline{X}_{S_1,\delta_1} \times \overline{X}_{S_2,\delta_2}. \tag{3}$$

En itérant, on déduit que les sommets de $\overline{X}_{S,\delta}$ sont indexés par les triangulations de (S, δ) .

2.2. Intégrales des périodes

Il existe une unique (à multiplication près par un scalaire rationnel) ℓ -forme régulière $\omega_{S,\delta}$ sur $\mathfrak{M}_{0,S}$ qui n'a ni pôles ni zéros le long des diviseurs D_{ij} , pour $\{i, j\} \in \chi_{S,\delta}$. Elle est invariante par l'action du groupe $D_{(S,\delta)}$.

Proposition 1. Soit $\alpha = (\alpha_{ij})_{\{i,j\} \in \chi_{S,\delta}}$ un ensemble d'indices, où $\alpha_{ij} \in \mathbb{Z}$. L'intégrale

$$I_{S,\delta}(\alpha) = \int_{\overline{X}_{S,\delta}} \prod_{\{i,j\} \in \chi_{S,\delta}} u_{ij}^{\alpha_{ij}} \omega_{S,\delta} \tag{4}$$

converge si et seulement si $\alpha_{ij} \geq 0$ pour tout $\{i, j\} \in \chi_{S,\delta}$. Dans ces conditions, l'intégrand est continu sur le domaine compact $\overline{X}_{S,\delta}$, et l'intégrale est réelle et positive.

Ecrivons la même intégrale en *coordonnées simpliciales*. Par la triple transitivité de PSL_2 , nous pouvons placer les points marqués z_1 en 1, z_2 à l'infini, et z_3 en 0. Prenons comme coordonnées $t_1 = z_4, \dots, t_\ell = z_n$, et identifions $\mathfrak{M}_{0,S}(\mathbb{C})$ avec le complémentaire d'une configuration d'hyperplans affine :

$$\mathfrak{M}_{0,S}(\mathbb{C}) \cong \{(t_1, \dots, t_\ell) \in \mathbb{C}^\ell : t_i \neq 0, 1 : t_i \neq t_j, \text{ pour } 1 \leq i < j \leq \ell\}. \tag{5}$$

Avec ces coordonnées (t_1, \dots, t_ℓ) , on vérifie aisément que le domaine $X_{S,\delta}$ correspond au simplexe ouvert $\{(t_1, \dots, t_\ell) \in \mathbb{R}^\ell : 0 < t_1 < t_2 < \dots < t_\ell < 1\}$, et il s'ensuit que les intégrales $I_{S,\delta}(\alpha)$ s'écrivent :

$$I_{S,\delta}(\alpha) = \int_{0 < t_1 < \dots < t_\ell < 1} \prod_i t_i^{a_i} (1 - t_i)^{b_i} \prod_{i < j} (t_j - t_i)^{c_{ij}} dt_1 \dots dt_\ell, \tag{6}$$

où les indices $a_i, b_i, c_{ij} \in \mathbb{Z}$ sont des combinaisons linéaires explicites des indices α_{ij} et 1. Certaines sous-familles de ces intégrales ont été considérées par divers auteurs (voir la bibliographie de [6]).

Théorème 2.1. *L'intégrale $I_{S,\delta}(\alpha)$ est \mathbb{Q} -combinaison linéaire des valeurs zêtas multiples de poids $\leq \ell$.*

Le Théorème 1.1 peut s'en déduire par un argument de résidus en théorie de Hodge [1].

3. La construction bar sur $\mathfrak{M}_{0,S}$ et primitives

Notons $\mathcal{O}(\mathfrak{M}_{0,S}) = \mathbb{Q}[u_{ij}, u_{ij}^{-1}, \{i, j\} \in \chi_{S,\delta}]$ l'anneau des fonctions régulières sur $\mathfrak{M}_{0,S}$. Nous pouvons formellement rajouter des primitives successives à cette algèbre en utilisant la construction suivante. Soit $\omega_{ij} = du_{ij}/u_{ij}$ la dérivée logarithmique de la coordonnée diédrale u_{ij} , pour $\{i, j\} \in \chi_{S,\delta}$. Ensuite, pour tout $m \geq 2$, soit V_m le \mathbb{Q} -espace vectoriel engendré librement par les symboles

$$\sum_{I=(c_1, \dots, c_m)} a_I [\omega_{c_1} | \dots | \omega_{c_m}], \quad \text{où les } c_i \in \chi_{S,\delta}, \text{ et } a_I \in \mathbb{Q},$$

qui satisfont à la condition suivante pour tout $1 \leq k \leq m - 1$:

$$\sum_I a_I \omega_{c_1} \otimes \dots \otimes (\omega_{c_k} \wedge \omega_{c_{k+1}}) \otimes \dots \otimes \omega_{c_m} = 0 \in H^1(\mathfrak{M}_{0,S})^{\otimes(k-1)} \otimes H^2(\mathfrak{M}_{0,S}) \otimes H^1(\mathfrak{M}_{0,S})^{\otimes(m-k-1)}, \quad (7)$$

où $H^i(\mathfrak{M}_{0,S})$ désigne la cohomologie de de Rham. On pose $V_0 = \mathbb{Q}$, et $V_1 = \bigoplus_{c \in \chi_{S,\delta}} \mathbb{Q}[\omega_c] \cong H^1(\mathfrak{M}_{0,S})$. Considérons l'espace vectoriel gradué :

$$B(\mathfrak{M}_{0,S}) = \mathcal{O}(\mathfrak{M}_{0,S}) \otimes_{\mathbb{Q}} \bigoplus_{m \geq 0} V_m. \quad (8)$$

On démontre que c'est une algèbre commutative pour le produit de mélange que l'on note \boxtimes [1]. C'est une version de la construction bar étudiée par Chen [3,9]. Soit maintenant $\Omega^i(\mathfrak{M}_{0,S})$ l'ensemble des i -formes régulières sur $\mathfrak{M}_{0,S}$, et posons $\Omega^i B(\mathfrak{M}_{0,S}) = B(\mathfrak{M}_{0,S}) \otimes_{\mathcal{O}(\mathfrak{M}_{0,S})} \Omega^i(\mathfrak{M}_{0,S})$. On définit une différentielle $d : V_m \rightarrow \Omega^1(\mathfrak{M}_{0,S}) \otimes_{\mathbb{Q}} V_{m-1}$ par la formule

$$d \sum_{I=(c_1, \dots, c_m)} a_I [\omega_{c_1} | \dots | \omega_{c_m}] = \sum_{I=(c_1, \dots, c_m)} a_I \omega_{c_1} [\omega_{c_2} | \dots | \omega_{c_m}].$$

Elle se prolonge, via la formule de Leibniz, en une application $d : \Omega^i B(\mathfrak{M}_{0,S}) \rightarrow \Omega^{i+1} B(\mathfrak{M}_{0,S})$ pour $1 \leq i \leq \ell$. Il découle de la condition (7) que $d^2 = 0$. Nous avons donc un complexe de de Rham :

$$0 \longrightarrow B(\mathfrak{M}_{0,S}) \xrightarrow{d} \Omega^1 B(\mathfrak{M}_{0,S}) \xrightarrow{d} \Omega^2 B(\mathfrak{M}_{0,S}) \xrightarrow{d} \dots \xrightarrow{d} \Omega^\ell B(\mathfrak{M}_{0,S}) \longrightarrow 0,$$

dont le groupe de cohomologie en degré i sera noté $H_{\text{DR}}^i(B(\mathfrak{M}_{0,S}))$.

Théorème 3.1. *$H_{\text{DR}}^0(B(\mathfrak{M}_{0,S})) = \mathbb{Q}$, et $H_{\text{DR}}^i(B(\mathfrak{M}_{0,S})) = 0$ pour tout $i \geq 1$.*

4. Régularisation canonique des polylogarithmes multiples

On appellera *fonction multivaluée* sur $\mathfrak{M}_{0,S}$ toute fonction holomorphe définie sur un revêtement universel de $\mathfrak{M}_{0,S}$. Nous voulons définir une réalisation de l'algèbre $B(\mathfrak{M}_{0,S})$ par des fonctions multivaluées. Pour régulariser leurs singularités logarithmiques à l'infini, on considère leur série génératrice qui sera solution d'une certaine équation différentielle. Pour la définir, soient $\delta_{ij}, \{i, j\} \in \chi_{S,\delta}$, des symboles qui satisfont à $\delta_{ij} = \delta_{ji}$, et considérons la forme différentielle formelle :

$$\Omega_{S,\delta} = \sum_{\{i,j\} \in \chi_{S,\delta}} \delta_{ij} \omega_{ij}.$$

L'intégrabilité de cette forme s'écrit $d \Omega_{S,\delta} = \Omega_{S,\delta} \wedge \Omega_{S,\delta}$. Cela équivaut aux relations quadratiques

$$[\delta_{i-1j} + \delta_{ij-1} - \delta_{i-1j-1} - \delta_{ij}, \delta_{k-1l} + \delta_{kl-1} - \delta_{k-1l-1} - \delta_{kl}] = 0, \quad \text{pour tout } i, j, k, l \in S, \quad (9)$$

où l'on pose $\delta_{ii} = 0$ et $\delta_{ij} = 0$ lorsque i et j sont consécutifs. On définit ensuite $\widehat{\mathfrak{B}}_{S,\delta}(\mathbb{C})$ comme étant l'anneau des séries formelles non-commutatives en les δ_{ij} à coefficients dans \mathbb{C} , modulo les relations (9). On peut donc considérer l'équation différentielle suivante :

$$dL = \Omega_{S,\delta}L, \tag{10}$$

où L est une fonction multivaluée sur $\mathfrak{M}_{0,S}$ à valeurs dans $\widehat{\mathfrak{B}}_{S,\delta}(\mathbb{C})$.

Théorème 4.1. *Pour tout sommet v de l'associaèdre $\overline{X}_{S,\delta}$, soit F_v l'ensemble des faces qui rencontrent v . Il y a une unique solution $L_{v,\delta}(z)$ de l'équation différentielle (10) telle que*

$$L_{v,\delta}(z) = f_{v,\delta}(z) \exp\left(\sum_{\{i,j\}: F_{ij} \in F_v} \delta_{ij} \log u_{ij}\right),$$

où $f_{v,\delta}(z)$ est holomorphe dans un voisinage ouvert de v dans $\mathfrak{M}_{0,S}^\delta(\mathbb{C})$ et $f_{v,\delta}(v) = 1$.

L'énoncé est bien défini parce que les relations (9) entraînent que les δ_{ij} qui interviennent dans le membre de droite commutent. Ce théorème se démontre dans [1] par un théorème de Fuchs généralisé à plusieurs variables complexes et redonne des résultats analogues de Drinfeld et Kapranov [5,10] pour l'équation de Knizhnik–Zamolodchikov [11]. Les coefficients de la série $L_{v,\delta}(z)$ peuvent se calculer explicitement en coordonnées simpliciales (5). Ce sont des polylogarithmes multiples [2,7] :

$$Li_{n_1, \dots, n_r}\left(\frac{t_{i_1}}{t_{i_2}}, \dots, \frac{t_{i_{r-1}}}{t_{i_r}}, t_{i_r}\right) = \sum_{0 < m_1 < \dots < m_r} \frac{t_{i_1}^{m_1} t_{i_2}^{m_2 - m_1} \dots t_{i_r}^{m_r - m_{r-1}}}{m_1^{n_1} \dots m_r^{n_r}},$$

où les indices i_1, \dots, i_r sont compris entre 1 et ℓ . Il apparaît aussi des fonctions logarithmes $\log t_i$. On en déduit facilement que la monodromie de $L_{v,\delta}(z)$ s'exprime explicitement en fonction des valeurs zêtas multiples et de la constante $2i\pi$, et que la limite régularisée de $L_{v,\delta}(z)$ en tout sommet w de $\overline{X}_{S,\delta}$ est une série à coefficients dans l'algèbre \mathcal{Z} des valeurs zêtas multiples.

Soit $L^{v,\delta}(\mathfrak{M}_{0,S})$ la $\mathcal{O}(\mathfrak{M}_{0,S})$ -algèbre engendrée par les coefficients de la série $L_{v,\delta}(z)$ solution de l'équation différentielle (10). C'est une algèbre différentielle de fonctions multivaluées sur $\mathfrak{M}_{0,S}$. Dans [1] on construit la *réalisation régularisée* qui est un isomorphisme d'algèbres différentielles graduées :

$$\rho_{v,\delta} : B(\mathfrak{M}_{0,S}) \xrightarrow{\sim} L^{v,\delta}(\mathfrak{M}_{0,S}).$$

Cette application envoie le symbole $[\omega_{ij}]$ sur $\log u_{ij}$, pour tout $\{i, j\} \in \chi_{S,\delta}$. On définit maintenant :

$$L_{\mathcal{Z}}^\delta(\mathfrak{M}_{0,S}) = \mathcal{Z} \otimes L^{v,\delta}(\mathfrak{M}_{0,S}).$$

C'est une algèbre différentielle *filtrée*, dont l'anneau des constantes est \mathcal{Z} . Elle ne dépend pas du choix du sommet v par les remarques ci-dessus, et sa cohomologie est triviale par le Théorème 3.1.

Théorème 4.2. $L_{\mathcal{Z}}^\delta(\mathfrak{M}_{0,S})$ satisfait (en particulier) aux propriétés suivantes :

- (i) La sous-algèbre des éléments de poids 0 dans $L_{\mathcal{Z}}^\delta(\mathfrak{M}_{0,S})$ contient $\mathcal{O}(\mathfrak{M}_{0,S})$.
- (ii) Toute ℓ -forme de poids k à coefficients dans $L_{\mathcal{Z}}^\delta(\mathfrak{M}_{0,S})$ a une primitive de poids au plus $k + 1$.
- (iii) Si $f \in L_{\mathcal{Z}}^\delta(\mathfrak{M}_{0,S})$ est de poids au plus k , sa limite régularisée en un diviseur $D_{ij} \cong \mathfrak{M}_{0,S_1}^{\delta_1} \times \mathfrak{M}_{0,S_2}^{\delta_2}$ est une somme de produits de fonctions $f_1 f_2$ de poids total au plus k , où $f_i \in L_{\mathcal{Z}}^{\delta_i}(\mathfrak{M}_{0,S_i})$, pour $i = 1, 2$.

5. Esquisse de démonstration du Théorème 2.1

Partons d'une ℓ -forme $f \in \Omega^\ell L_{\mathcal{Z}}^\delta(\mathfrak{M}_{0,S})$, de poids au plus k . On sait par (ii) qu'elle possède une primitive P dans $\Omega^{\ell-1} L_{\mathcal{Z}}^\delta(\mathfrak{M}_{0,S})$ de poids au plus $k + 1$. Par une version adaptée de la formule de Stokes,

$$\int_{\overline{X}_{S,\delta}} f = \int_{\partial \overline{X}_{S,\delta}} P = \sum_{\{i,j\} \in \chi_{S,\delta}} \int_{F_{ij}} P|_{F_{ij}}.$$

Or, nous savons par (iii) que la restriction de P à une facette $F_{ij} \cong \overline{X}_{S_1, \delta_1} \times \overline{X}_{S_2, \delta_2}$ se décompose en une somme de produits $\sum P_{m_1} P_{m_2}$ où $P_{m_i} \in L_{\mathcal{Z}}^{\delta_i}(\mathfrak{M}_{0, S_i})$ pour $i = 1, 2$. Chaque intégrale dans la somme à droite se décompose en une somme finie :

$$\int_{F_{ij}} P = \sum_{m_1, m_2} \int_{\overline{X}_{S_1, \delta_1}} P_{m_1} \int_{\overline{X}_{S_2, \delta_2}} P_{m_2}.$$

Il reste à calculer l'intégrale des formes P_{m_i} de poids au plus $k + 1$ sur des associaèdres $\overline{X}_{S_i, \delta_i}$ qui sont de dimension $\leq \ell - 1$. On procède par récurrence. A chaque étape le poids de l'intégrand croît, mais la dimension du domaine d'intégration décroît. A la dernière étape il nous reste des constantes dans \mathcal{Z} de poids au plus $\ell + k$. Le Théorème 2.1 s'obtient en appliquant cet argument aux intégrales $I(\alpha)$.

Remarque 1. Pour que l'argument marche, il faut contrôler les singularités. La règle est que les fonctions à intégrer n'ont jamais de pôles sur le domaine d'intégration, mais *peuvent avoir des singularités logarithmiques* le long du bord. Il faut utiliser le fait miraculeux suivant : si P est la primitive d'une forme f qui a des singularités logarithmiques sur $\partial \overline{X}_{S, \delta}$, et si P n'a pas de pôles, alors P se prolonge continument sur $\overline{X}_{S, \delta}$ tout entier. Cela peut se voir immédiatement sur l'exemple $f = \log x dx$ sur $\{x: x > 0\}$, qui est singulier en 0. La primitive $P = x \log x - x$ est alors continue en 0.

Références

- [1] F.C.S. Brown, Périodes des espaces des modules $\mathfrak{M}_{0, n}$ et valeurs zêta multiples, thèse de Doctorat, Univ. de Bordeaux 1, 2006.
- [2] F.C.S. Brown, Polylogarithmes multiples uniformes en une variable, C. R. Acad. Sci. Paris, Ser. I 338 (2004) 527–532.
- [3] K.T. Chen, Extension of C^∞ function algebra by integrals and Malcev completion of π_1^* , Adv. in Math. (2) 23 (1977) 181–210.
- [4] P. Deligne, D. Mumford, The irreducibility of the space of curves of a given genus, Publ. Math. IHES 36 (1969) 75–109.
- [5] V.G. Drinfeld, On quasitriangular quasi-Hopf algebras and on a group that is closely connected with $\text{Gal}(\overline{\mathbb{Q}}/\mathbb{Q})$, Leningrad Math. J. 2 (4) (1991) 829–860.
- [6] S. Fischler, Irrationalité de valeurs de zêta [d'après Apéry, Rivoal,...], Séminaire Bourbaki 2002–2003, Exposé 910, 2002.
- [7] A.B. Goncharov, Multiple polylogarithms and mixed Tate motives, preprint, 2001; arXiv: math.AG/0103059.
- [8] A.B. Goncharov, Y.I. Manin, Multiple ζ -motives and moduli spaces $\overline{\mathcal{M}}_{0, n}$, Compositio Math. 140 (2004) 1–14.
- [9] R.M. Hain, Classical polylogarithms, Part 2, Proc. Sympos. Pure Math. 55 (1994).
- [10] M.M. Kapranov, The permutoassociahedron, MacLane's coherence theorem and asymptotic zones for the KZ equation, J. Pure Appl. Algebra 85 (1993) 119–142.
- [11] V.G. Knizhnik, A.B. Zamolodchikov, Current algebras and Wess–Zumino models in two dimensions, Nucl. Phys. B 247 (1984) 83–103.
- [12] S.A. Zlobin, Properties of coefficients of certain linear forms in generalized polylogarithms, preprint, 2005; arXiv: math.NT/0511245.
- [13] T. Terasoma, Selberg integrals and multiple zeta values, Compos. Math 133 (1) (2002) 1–24.
- [14] M. Waldschmidt, Valeurs zêtas multiples : une introduction, J. Théorie des Nombres de Bordeaux 12 (2002) 581–595.

FRANCIS C.S. BROWN

Multiple zeta values and periods of moduli spaces $\overline{\mathfrak{M}}_{0,n}(\mathbb{R})$.

ABSTRACT. We prove a conjecture due to Goncharov and Manin which states that the period of the moduli spaces $\mathfrak{M}_{0,n}$ of Riemann spheres with n marked points are multiple zeta values. We do this by introducing a differential algebra of multiple polylogarithms on $\mathfrak{M}_{0,n}$ and proving that it is closed under the operation of taking primitives. The main idea is to apply a version of Stokes' formula iteratively to reduce each period integral to multiple zeta values.

We also give a geometric interpretation of the double shuffle relations, by showing that they are two extreme cases of general product formulae for periods which arise by considering natural maps between moduli spaces.

ABSTRACT. Nous démontrons une conjecture de Goncharov et Manin qui prédit que les périodes des espaces de modules $\mathfrak{M}_{0,n}$ des courbes de genre 0 avec n points marqués sont des valeurs zêtas multiples. Nous introduisons une algèbre différentielle de fonctions polylogarithmes multiples sur $\mathfrak{M}_{0,n}$ dans laquelle il existe des primitives. L'idée principale est d'appliquer une version de la formule de Stokes récursivement pour réduire chaque intégrale de périodes à une combinaison linéaire de valeurs zêtas multiples.

Nous donnons également une interprétation géométrique des double relations de mélange pour les valeurs zêtas multiples. En considérant des applications naturelles entre les espaces des modules, on déduit des formules de produit générales entre leurs périodes. Les doubles relations de mélange s'obtiennent comme deux cas particuliers de cette construction.

CONTENTS.

1. Introduction	2
2. Dihedral coordinates on $\overline{\mathfrak{M}}_{0,n}(\mathbb{R})$	11
3. The reduced Bar construction and Picard-Vessiot theory	33
4. Manifolds with corners and Fuchsian differential equations	53
5. Hyperlogarithms	61
6. The universal algebra of polylogarithms on $\mathfrak{M}_{0,n}$	67
7. Period integrals on $\overline{\mathfrak{M}}_{0,n}(\mathbb{R})$ and generalised shuffle products	84
8. Calculation of the periods of $\mathfrak{M}_{0,n}$	97
9. Appendix	104
10. Bibliography	105
11. Index of Notations	109

1. INTRODUCTION

Let $n = \ell + 3 \geq 4$, and let $\mathfrak{M}_{0,n}$ denote the moduli space of curves of genus 0 with n marked points. There is a smooth compactification $\overline{\mathfrak{M}}_{0,n}$, defined by Deligne, Knudsen and Mumford, such that the complement

$$\overline{\mathfrak{M}}_{0,n} \setminus \mathfrak{M}_{0,n}$$

is a normal crossing divisor. Let $A, B \subset \overline{\mathfrak{M}}_{0,n} \setminus \mathfrak{M}_{0,n}$ denote two sets of boundary divisors which share no irreducible components. In [G-M], Goncharov and Manin show that the relative cohomology group

$$(1.1) \quad H^\ell(\overline{\mathfrak{M}}_{0,n} \setminus A, B \setminus B \cap A)$$

defines a mixed Tate motive which is unramified over \mathbb{Z} .

On the other hand, let $n_1, \dots, n_r \in \mathbb{N}$, and suppose that $n_r \geq 2$. The multiple zeta value $\zeta(n_1, \dots, n_r)$ is the real number defined by the convergent sum

$$(1.2) \quad \zeta(n_1, \dots, n_r) = \sum_{0 < k_1 < \dots < k_r} \frac{1}{k_1^{n_1} \dots k_r^{n_r}}.$$

Its weight is the quantity $n_1 + \dots + n_r$, and its depth is the number of indices r . We will say that the period $2i\pi$ has weight 1. A very general conjecture [Go1] claims that the periods of any mixed Tate motive unramified over \mathbb{Z} are multiple zeta values. In the case of the motives (1.1) arising from moduli spaces, this says the following. Consider a real smooth compact submanifold $X_B \subset \overline{\mathfrak{M}}_{0,n}$ of dimension ℓ , whose boundary is contained in B and which does not meet A . It represents a class in $H_\ell(\overline{\mathfrak{M}}_{0,n}, B)$. Let $\omega_A \in \Omega^\ell(\overline{\mathfrak{M}}_{0,n} \setminus A)$ denote an algebraic form with singularities contained in A . In [G-M], Goncharov and Manin conjecture that the integral

$$(1.3) \quad I = \int_{X_B} \omega_A$$

is a linear combination of multiple zeta values, and proved that every multiple zeta value can occur as such a period integral. In this paper, we develop some general methods for computing periods and prove this conjecture as an application.

Theorem 1.1. *The integral I is a $\mathbb{Q}[2\pi i]$ -linear combination of multiple zeta values of weight at most ℓ .*

This theorem thus lends significant weight to the conjecture on the periods of all mixed Tate motives which are unramified over \mathbb{Z} .

The rough idea of our method is as follows. The set of real points $\mathfrak{M}_{0,n}(\mathbb{R})$ is tessellated by a number of open cells X_n which can naturally be identified with a Stasheff polytope, or associahedron. We can reduce to the case where the domain of integration in (1.3) is a single cell X_n . The key is then to apply a version of Stokes' theorem to the closed polytope $\overline{X}_n \subset \overline{\mathfrak{M}}_{0,n}(\mathbb{R})$. Since each face of \overline{X}_n is itself a product of associahedra $\overline{X}_a \times \overline{X}_b$, we repeatedly take primitives to obtain a cascade of integrals over associahedra of smaller and smaller dimension. In order to do this, we need to construct a graded algebra $L(\mathfrak{M}_{0,n})$ of multiple polylogarithm functions on $\mathfrak{M}_{0,n}$ in which primitives exist. At each stage of the induction, the dimension of the domain of integration decreases by one, and the weight of the integrand increases by one. At the final stage, we evaluate a multiple polylogarithm at the point 1, and this gives a linear combination of multiple zeta values. This gives an effective algorithm for computing such integrals. Our approach also works in

greater generality, and our results should extend without difficulty, for example, to the case of configuration spaces related to other Coxeter groups.

1.1. General overview. This paper is essentially a study of the de Rham theory of the motivic fundamental group of $\mathfrak{M}_{0,n}$. Previously, the focus has mainly been on the projective line minus roots of unity and its products: in particular, $\mathfrak{M}_{0,4} \cong \mathbb{P}^1 \setminus \{0, 1, \infty\}$ and $\mathfrak{M}_{0,4}^\ell$ ([De1], [D-G], [Go1-2], [Ra]). The advantage of considering the moduli spaces $\mathfrak{M}_{0,n}$ is that we can bring to bear the full richness of their geometry. We show, for example, that the double shuffle relations for multiple zeta values are just two special cases of generalised product relations arising naturally from functorial maps between moduli spaces. An essential part of this work is devoted to multiple polylogarithms, which are functions first defined by Goncharov for all $n_1, \dots, n_\ell \in \mathbb{N}$ by the power series:

$$(1.4) \quad \text{Li}_{n_1, \dots, n_\ell}(x_1, \dots, x_\ell) = \sum_{0 < k_1 < \dots < k_\ell} \frac{x_1^{k_1} \dots x_\ell^{k_\ell}}{k_1^{n_1} \dots k_\ell^{n_\ell}}, \quad \text{where } |x_i| < 1.$$

By analytic continuation, they define multi-valued functions on $\mathfrak{M}_{0,n}$, where $n = \ell + 3$. One of our main objects of study in this paper is the larger set $L(\mathfrak{M}_{0,n})$ of all homotopy-invariant iterated integrals on $\mathfrak{M}_{0,n}$. It forms a differential algebra of multi-valued functions on $\mathfrak{M}_{0,n}$, in which the set of functions (1.4) is strictly contained. From the point of view of differential Galois theory, $L(\mathfrak{M}_{0,n})$ defines a maximal unipotent Picard-Vessiot theory on $\mathfrak{M}_{0,n}$. We then define the universal algebra of multiple polylogarithms $B(\mathfrak{M}_{0,n})$ to be a modified version of Chen's reduced bar construction. It is a differential graded Hopf algebra which is an abstract algebraic version of $L(\mathfrak{M}_{0,n})$. One of our key results states that the de Rham cohomology of $B(\mathfrak{M}_{0,n})$ is trivial. From this we deduce the existence of primitives in $L(\mathfrak{M}_{0,n})$. We also need to understand the regularised restriction of polylogarithms to the faces of \overline{X}_n . This requires a canonical regularisation theorem, and amounts to studying what happens when singularities of an iterated integral collide. We are thus led to work on certain blow-ups of $\mathfrak{M}_{0,n}$, described below. It follows that the structure of $L(\mathfrak{M}_{0,n})$, and hence the function theory of multiple polylogarithms, is intimately related to the combinatorics of the associahedron.

1.2. Detailed summary of results. In section 2 we review some aspects of the geometry of the moduli spaces $\mathfrak{M}_{0,n}$, and study certain blow-ups obtained from them. Let S denote a set with n elements, each labelling a marked point on the projective line \mathbb{P}^1 , and write $\mathfrak{M}_{0,S} = \mathfrak{M}_{0,n}$. A *dihedral structure* on S is an identification of S with the set of edges (or vertices) of an unoriented n -gon. For each such dihedral structure δ , we embed $\mathfrak{M}_{0,S}$ in the affine space \mathbb{A}^ℓ , where $\ell = n - 3$, and blow up parts of the boundary in $\mathbb{A}^\ell \setminus \mathfrak{M}_{0,S}$ to obtain an intermediary space

$$\mathfrak{M}_{0,S} \subset \mathfrak{M}_{0,S}^\delta \subset \overline{\mathfrak{M}}_{0,S},$$

where $\mathfrak{M}_{0,S}^\delta$ is an affine scheme defined over \mathbb{Z} . We prove that the set of $\mathfrak{M}_{0,S}^\delta$, for varying δ , form a set of smooth affine charts on $\overline{\mathfrak{M}}_{0,S}$. In order to define them, we introduce *dihedral coordinates*, which are one of the key tools used throughout this paper. These are functions

$$u_{ij} : \mathfrak{M}_{0,S} \rightarrow \mathbb{P}^1 \setminus \{0, 1, \infty\}, \quad \text{where } \{i, j\} \in \chi_{S,\delta},$$

indexed by the set of chords $\chi_{S,\delta}$ in the n -gon defined by δ . Together, they define an embedding $(u_{ij})_{\chi_{S,\delta}} : \mathfrak{M}_{0,S} \rightarrow \mathbb{A}^{n(n-3)/2}$, and the scheme $\mathfrak{M}_{0,S}^\delta$ is the Zariski closure of the image of this map. For example, in the case $n = 5$, we can identify $\mathfrak{M}_{0,S} = \{(t_1, t_2) \in \mathbb{P}^1 \times \mathbb{P}^1 : t_1 t_2 (1 - t_1)(1 - t_2)(t_1 - t_2) \neq 0, t_1, t_2 \neq \infty\}$. The pentagon (S, δ) has five chords, labelled $\{13, 24, 35, 41, 52\}$ (fig. 1), and we have

$$u_{13} = 1 - t_1, \quad u_{24} = \frac{t_1}{t_2}, \quad u_{35} = \frac{t_2 - t_1}{t_2(1 - t_1)}, \quad u_{41} = \frac{1 - t_2}{1 - t_1}, \quad u_{52} = t_2 .$$

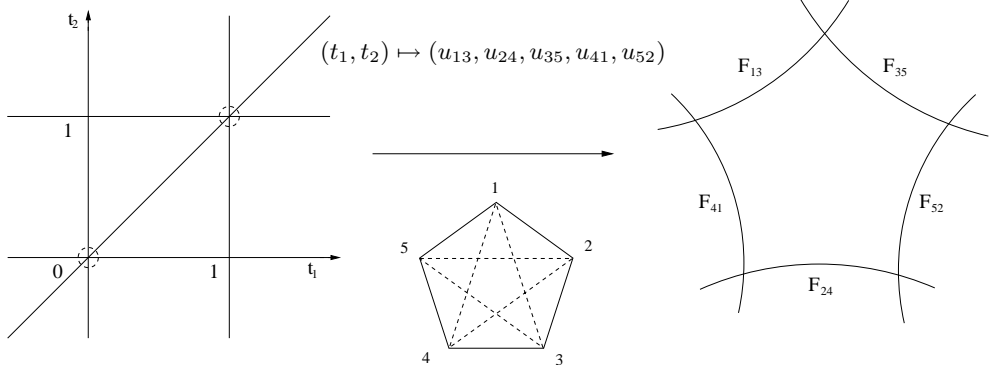

FIGURE 1. Dihedral coordinates on $\mathfrak{M}_{0,5}$. The scheme $\mathfrak{M}_{0,5}^\delta$ (right) is defined to be the Zariski closure of the image of the embedding $\{u_{ij}\} : \mathfrak{M}_{0,5} \hookrightarrow \mathbb{A}^5$ defined by the set of dihedral coordinates, which are indexed by chords in a pentagon (middle). This map has the effect of blowing up the points $(0, 0)$ and $(1, 1)$. A cell $X_{S,\delta}$ is given by the region $0 < t_1 < t_2 < 1$ (left). After blowing-up it becomes a pentagon with sides $F_{ij} = \{u_{ij} = 0\}$.

Now consider the set of real points $\mathfrak{M}_{0,S}(\mathbb{R})$. There is a bounded cell $X_{S,\delta} \subset \mathfrak{M}_{0,S}(\mathbb{R})$ defined by the region $\{0 < u_{ij} < 1\}$. One shows that $\mathfrak{M}_{0,S}(\mathbb{R})$ is the disjoint union of the open cells $X_{S,\delta}$ of dimension $\ell = n - 3$, as δ runs over the set of dihedral structures on S , so a dihedral structure corresponds to choosing a connected component of $\mathfrak{M}_{0,S}(\mathbb{R})$. The closure of the cell $\overline{X}_{S,\delta}$ satisfies

$$(1.5) \quad \overline{X}_{S,\delta} = \{0 \leq u_{ij} \leq 1\} \subset \mathfrak{M}_{0,S}^\delta(\mathbb{R}) ,$$

and $\mathfrak{M}_{0,S}^\delta \setminus \mathfrak{M}_{0,S}$ is the union of all divisors meeting the boundary of $X_{S,\delta}$. Therefore $\overline{X}_{S,\delta}$ is a convex polytope, and its boundary divisors give an explicit algebraic model of the associahedron. It is well-known that the combinatorics of the associahedron is given by triangulations of polygons. But because dihedral coordinates are already defined in terms of polygons, the main combinatorial properties of the associahedron, and its dihedral symmetry, follow immediately from properties of the coordinates u_{ij} . In particular, the face $F_{ij} = \{u_{ij} = 0\}$ of $\overline{X}_{S,\delta}$ is a product

$$(1.6) \quad F_{ij} \cong \overline{X}_{T_1,\delta_1} \times \overline{X}_{T_2,\delta_2} ,$$

where $(T_1, \delta_1), (T_2, \delta_2)$ are two smaller polygons obtained by cutting the n -gon S along the chord $\{i, j\}$ (fig. 3, §2.2). In this way, a vertex v of $\overline{X}_{S,\delta}$ corresponds to a complete triangulation α of the n -gon by ℓ chords. We also introduce explicit

vertex coordinates $x_1^\alpha, \dots, x_\ell^\alpha$ which are a certain subset of the set of all dihedral coordinates. These form a system of normal parameters in the neighbourhood of the vertex $v \in \overline{X}_{S,\delta}$ corresponding to α , such that $\mathfrak{M}_{0,S}(\mathbb{R}) \subset \overline{\mathfrak{M}}_{0,S}(\mathbb{R})$ is locally the complement of the normal crossing divisor $x_1^\alpha \dots x_\ell^\alpha = 0$. These systems of coordinates (in the sense of differential geometry) are precisely what is needed for solving differential equations on $\mathfrak{M}_{0,S}$ and regularising logarithmic singularities of multiple polylogarithms.

In section 3 we define an abstract algebra of iterated integrals on $\mathfrak{M}_{0,S}$ using a variant of Chen's reduced bar construction. Since this construction exists in far greater generality, we consider the complement of an arbitrary affine hyperplane arrangement defined over a field k of characteristic 0. So let

$$M = \mathbb{A}^\ell \setminus \bigcup_{i=1}^N H_i ,$$

where H_1, \dots, H_N is any set of hyperplanes in \mathbb{A}^ℓ . Let t_1, \dots, t_ℓ denote coordinates on \mathbb{A}^ℓ , and let \mathcal{O}_M denote the ring of regular functions on M . It is a differential k -algebra with respect to the coordinate derivations $\partial/\partial t_i$, for $1 \leq i \leq \ell$. Let

$$\omega_i = \frac{d\alpha_i}{\alpha_i} , \quad \text{for } 1 \leq i \leq N ,$$

denote the logarithmic 1-form corresponding to H_i , where α_i is a defining equation for H_i . The version of the bar construction $B(M)$ we consider is defined as follows. Let $V_m(M)$ denote the k -vector space generated by linear combinations of symbols

$$(1.7) \quad \sum_{I=(i_1, \dots, i_m)} c_I [\omega_{i_1} | \dots | \omega_{i_m}] , \quad c_I \in k ,$$

which satisfy the integrability condition:

$$(1.8) \quad \sum_I c_I \omega_{i_1} \otimes \dots \otimes (\omega_{i_j} \wedge \omega_{i_{j+1}}) \otimes \dots \otimes \omega_{i_m} = 0 \quad \text{for all } 1 \leq j < m .$$

We then set $B(M) = \mathcal{O}_M \otimes_k \bigoplus_{m \geq 0} V_m(M)$, where $V_0(M) = k$. This is a graded Hopf algebra over \mathcal{O}_M which is similar to the zeroth cohomology group of the bar complex studied by Chen [Ch1], except that it consists of 1-forms only (see also [Ha1]). Using the 1-part of the coproduct on $B(M)$, we define the action of ℓ commuting derivations ∂_i on $B(M)$, and show that $(B(M), \partial_i)$ defines a differential extension of $(\mathcal{O}_M, \partial/\partial t_i)$. The possibility of using iterated integrals to construct a Picard-Vessiot theory on manifolds was first suggested by Chen [Ch2].

Theorem 1.2. *$B(M)$ is an infinite unipotent Picard-Vessiot extension of \mathcal{O}_M . In other words, it has no non-trivial differential ideals and its ring of constants is k . It is therefore a polynomial algebra. Furthermore, $B(M)$ contains 1-primitives:*

$$H_{\text{DR}}^1(B(M)) = 0 .$$

It follows that every unipotent extension of $B(M)$ is trivial, and it is the smallest extension of \mathcal{O}_M with this property. Equivalently, $B(M)$ is the limit

$$B(M) = \varinjlim U ,$$

where U ranges over all unipotent extensions U of \mathcal{O}_M . In this sense it is universal, and it follows that its differential Galois group is a pro-unipotent group. Now if we

identify $\mathfrak{M}_{0,S}$ with the affine hyperplane configuration

$$\mathfrak{M}_{0,S} \cong \{(t_1, \dots, t_\ell) \in \mathbb{A}^\ell : t_i \neq 0, 1, \quad t_i - t_j \neq 0\},$$

then we define the *universal algebra of polylogarithms* on $\mathfrak{M}_{0,S}$ to be $B(\mathfrak{M}_{0,S})$. In general, it is difficult to construct words (1.7) satisfying the integrability condition (1.8) since they rapidly become very complicated as the weight increases. In order to overcome this problem, we consider two affine hyperplane arrangements, one of which fibers linearly over the other. Therefore, let $M \subset \mathbb{A}^\ell$ and $M' \subset \mathbb{A}^{\ell-1}$ denote two affine arrangements, and consider a linear projection

$$\pi : M \rightarrow M'$$

with constant fibres F , where F is the affine line \mathbb{A}^1 minus a number of marked points. We then prove that there is a tensor product decomposition

$$B(M) \cong B(M') \otimes_{\mathcal{O}_{M'}} B_{M'}(F),$$

where $B_{M'}(F)$ is a free shuffle algebra which can be described explicitly. In the case of moduli spaces $\mathfrak{M}_{0,S}$, we apply this argument to the fibration map:

$$\mathfrak{M}_{0,n} \longrightarrow \mathfrak{M}_{0,n-1}$$

and use induction to deduce that $B(\mathfrak{M}_{0,S})$ is a tensor product of free shuffle algebras. As a result, one can write down a basis for $B(\mathfrak{M}_{0,S})$, and one deduces that the higher cohomology groups of $B(\mathfrak{M}_{0,S})$ vanish.

Theorem 1.3. *The de Rham cohomology of $B(\mathfrak{M}_{0,S})$ is trivial:*

$$H_{\text{DR}}^i(B(\mathfrak{M}_{0,S})) = 0 \quad \text{for all } i \geq 1.$$

A similar result holds for any hyperplane arrangement of fiber type, *i.e.*, one which can be obtained as a sequence of such fibrations. In an appendix we also prove that $H_{\text{DR}}^i(B(M))$, for $i \geq 1$, vanishes for all arrangements M which have quadratic cohomology. The proofs only use simple arguments of differential algebra. Theorem 1.3 holds because $\mathfrak{M}_{0,S}$ is a $K(\pi, 1)$ -rational space. An equivalent theorem is due to Hain and MacPherson ([H-M], [Kh2]).

Given any point $z_0 \in \mathfrak{M}_{0,S}(\mathbb{C})$ we define a realisation

$$(1.9) \quad \begin{aligned} \rho_{z_0} : B(\mathfrak{M}_{0,S}) &\xrightarrow{\sim} L_{z_0}(\mathfrak{M}_{0,S}) \\ \sum_I f_I [\omega_{i_1} | \dots | \omega_{i_m}] &\mapsto \sum_I f_I \int_{z_0}^z \omega_{i_m} \dots \omega_{i_1}, \end{aligned}$$

given by iterated integration along any path $\gamma : [0, 1] \rightarrow \mathfrak{M}_{0,S}(\mathbb{C})$ which begins at z_0 and ends at a variable point $z \in \mathfrak{M}_{0,S}(\mathbb{C})$. The integrability condition (1.8) ensures that the iterated integral (1.9) only depends on the homotopy class of γ . It therefore defines a multi-valued function of the parameter z , *i.e.*, a holomorphic function on the universal covering space of $\mathfrak{M}_{0,S}(\mathbb{C})$. Here, $L_{z_0}(\mathfrak{M}_{0,S})$ is a differential graded algebra of multi-valued functions on $\mathfrak{M}_{0,S}$. We deduce from the previous theorem that ℓ -forms with coefficients in $L_{z_0}(\mathfrak{M}_{0,S})$ have primitives in $L_{z_0}(\mathfrak{M}_{0,S})$.

The realisation ρ_{z_0} is not quite good enough, however. We actually need a realisation $\rho_{z_0} : B(\mathfrak{M}_{0,S}) \rightarrow L_{z_0}(\mathfrak{M}_{0,S})$, where the base point z_0 does not lie in $\mathfrak{M}_{0,S}(\mathbb{C})$. The point z_0 can be replaced with a tangential base point in the sense of [De1], but our approach consists instead of viewing z_0 as the corner of a manifold with corners. This gives rise to divergent integrals, and to deal with this requires a regularisation procedure. The best approach is to consider the generating series of

all such iterated integrals, and regularise them all simultaneously. Such a generating series satisfies a formal differential equation, and to solve it requires a generalised Fuchs' theorem in several variables in the unipotent case. For want of a suitable reference, we develop the necessary theory from scratch in section 4. We also study the regularisation of logarithmic singularities along the boundary of any manifold with corners. Section 5 is devoted to a detailed study of the case of a one dimensional arrangement $\mathbb{P}^1 \setminus \{\sigma_0, \dots, \sigma_N, \infty\}$. In this case, the bar construction can be written down explicitly (it is a free shuffle algebra), and the corresponding iterated integrals are known as hyperlogarithms, which go back to Poincaré and Lappo-Danilevsky.

In section 6, we apply all the results developed previously to the case of the moduli spaces $\mathfrak{M}_{0,S}$ to obtain the necessary regularisation results. The generating series of multiple polylogarithms can be described as follows. To each dihedral coordinate, or chord, is associated a logarithmic one-form

$$\omega_{ij} = d \log u_{ij} , \quad \text{for } \{i, j\} \in \chi_{S,\delta} .$$

It is symmetric in i and j . Let δ_{ij} , for $\{i, j\} \in \chi_{S,\delta}$, denote a set of symbols satisfying $\delta_{ij} = \delta_{ji}$, and consider the formal 1-form

$$(1.10) \quad \Omega_{S,\delta} = \sum_{\{i,j\} \in \chi_{S,\delta}} \delta_{ij} \omega_{ij} .$$

This is a homogeneous version of the Knizhnik-Zamolodchikov form [Dr, Ka, K-Z]. The integrability of $\Omega_{S,\delta}$ is equivalent to certain quadratic relations in the δ_{ij} , which we call the dihedral braid relations. In the special case $\mathfrak{M}_{0,5}$, these reduce to the relations:

$$[\delta_{ij}, \delta_{kl}] = 0 ,$$

for any pair of chords $\{i, j\}, \{k, l\}$ which do not cross, and the pentagonal relation

$$[\delta_{13}, \delta_{24}] + [\delta_{24}, \delta_{35}] + [\delta_{35}, \delta_{41}] + [\delta_{41}, \delta_{52}] + [\delta_{52}, \delta_{13}] = 0 .$$

Let us fix a dihedral structure δ on S , and let $\widehat{\mathfrak{B}}_{S,\delta}(\mathbb{C})$ denote the ring of non-commutative formal power series in the symbols δ_{ij} with coefficients in \mathbb{C} , modulo the dihedral braid relations. Then we can consider the formal differential equation

$$(1.11) \quad dL = \Omega_{S,\delta} L ,$$

where L takes values in $\widehat{\mathfrak{B}}_{S,\delta}(\mathbb{C})$.

Theorem 1.4. *Let v denote a vertex of the associahedron $\overline{X}_{S,\delta}$, and let F_v denote the set of faces meeting v . Then there is a unique solution $L_{v,\delta}$ of (1.11) such that*

$$L_{v,\delta}(z) = f_{v,\delta}(z) \exp\left(\sum_{\{i,j\}: F_{ij} \in F_v} \delta_{ij} \log u_{ij} \right) ,$$

where $f_{v,\delta}(z)$ is holomorphic in a neighbourhood of $v \in \mathfrak{M}_{0,S}^\delta$, and $f_{v,\delta}(v) = 1$.

In other words, the function $L_{v,\delta}(z)$ is holomorphic on an open set of $\mathfrak{M}_{0,S}^\delta(\mathbb{C})$ which contains the real cell $X_{S,\delta}$, and has explicitly given monodromy around each face $u_{ij} = 0$ of the associahedron $\overline{X}_{S,\delta}$ which meets the vertex v . The differential equation (1.11) is closely related to the Knizhnik-Zamolodchikov equation. Solutions to the latter equation are usually constructed by induction using fibration maps between configuration spaces. The previous theorem, however, is proved directly using the generalised Fuchs' theorem developed in section 4. This approach

has many advantages: firstly, there are no coherence conditions to verify; secondly, we obtain a direct geometric interpretation of Drinfeld's asymptotic zones, which were studied by Kapranov; and thirdly, the functoriality of the solution $L_{v,\delta}(z)$ with respect to maps between moduli spaces follows automatically. As a result, we obtain a direct definition of an associator on $\mathfrak{M}_{0,S}$ by considering the quotient of two different solutions:

$$Z^{v,v'} = (L_{v,\delta}(z))^{-1} L_{v',\delta}(z) \in \widehat{\mathfrak{B}}_{S,\delta}(\mathbb{C}) .$$

Here, z is any point in an open neighbourhood of $X_{S,\delta}$ in $\mathfrak{M}_{0,S}^\delta$. The quotient is necessarily constant. The main properties of Drinfeld's associator can be derived immediately. Using the previous theorem, we deduce an expression for the monodromy of $L_{v,\delta}(z)$ and its regularisation in terms of the series $Z^{v,v'}$ (§6.5). Then, using explicit expressions for hyperlogarithms, we deduce the following result, which was first proved by Le and Murakami, following Kontsevich.

Theorem 1.5. *The coefficients of the series $Z^{v,v'}$ are multiple zeta values.*

It follows that the holonomy of the moduli spaces $\mathfrak{M}_{0,S}$ can be expressed using multiple zeta values and the constant $2\pi i$. Now define $L^{v,\delta}(\mathfrak{M}_{0,S})$ to be the differential algebra generated by the coefficients of the series $L_{v,\delta}(z)$. We can then define the sought-after realisation $\rho_{v,\delta}$ which is regularised at the vertex v of $\overline{X}_{S,\delta}$:

$$\rho_{v,\delta} : B(\mathfrak{M}_{0,S}) \xrightarrow{\sim} L^{v,\delta}(\mathfrak{M}_{0,S}) ,$$

and which is defined over the field $k = \mathbb{Q}$. From this we deduce the main regularisation theorem, which describes the regularised restriction of a multiple polylogarithm to the face of the associahedron in terms of multiple zeta values.

Theorem 1.6. *Let F_{ij} denote a face of $\overline{X}_{S,\delta}$ isomorphic to a product $\overline{X}_{T_1,\delta_1} \times \overline{X}_{T_2,\delta_2}$ as in (1.6) above. Then if the vertex v corresponds to the pair (v_1, v_2) ,*

$$\text{Reg}(L^{v,\delta}(\mathfrak{M}_{0,S}), F_{ij}) \otimes_{\mathbb{Q}} \mathcal{Z} \cong L^{v_1,\delta_1}(\mathfrak{M}_{0,T_1}) \otimes_{\mathbb{Q}} L^{v_2,\delta_2}(\mathfrak{M}_{0,T_2}) \otimes_{\mathbb{Q}} \mathcal{Z} .$$

In other words, the regularisation of multiple polylogarithms along divisors at infinity is completely determined by the combinatorics of the associahedron.

In section 7, we study period integrals on $\mathfrak{M}_{0,S}(\mathbb{R})$ in terms of dihedral coordinates. We first show that, up to multiplication by a rational number, there is a unique algebraic ℓ -form $\omega_{S,\delta}$, which has neither zeros nor poles on $\mathfrak{M}_{0,S}^\delta$. This form is invariant under the natural action of the dihedral group. We deduce that one can write an arbitrary integral (1.3) as a linear combination of integrals

$$(1.12) \quad I_{S,\delta}(\alpha_{ij}) = \int_{\overline{X}_{S,\delta}} \prod_{\{i,j\} \in \chi_{S,\delta}} u_{ij}^{\alpha_{ij}} \omega_{S,\delta} ,$$

for some fixed dihedral structure δ , where the indices $\alpha_{ij} \in \mathbb{Z}$. Such an integral converges if and only if the coefficients α_{ij} are all non-negative. In explicit coordinates, (1.12) can be written as a generalized Selberg integral

$$I_{S,\delta}(\alpha_{ij}) = \int_{[0,1]^\ell} \prod_{i=1}^{\ell} x_i^{\alpha_i} (1-x_i)^{b_i} \prod_{i < j} (1-x_i x_{i+1} \dots x_j)^{c_{ij}} dx_1 \dots dx_\ell .$$

Particular subfamilies of these kinds of integrals have been considered by various authors in connection with the diophantine approximation of zeta values (see, *e.g.*, [Fi2, Zl, Zu]). Terasoma has also computed the Taylor expansions (with respect to

the exponents) of certain families of such integrals, and proved they are multiple zeta values [Ter]. The advantage of the blown-up integral representation (1.12) is that all poles of the integrand have been pushed to infinity, which allows an algebraic interpretation of the integrals as periods, and a systematic procedure for computing them, which is detailed in section 8 and summarised below. As a further application of dihedral coordinates, we give an explicit formula for the order of vanishing of any form

$$\prod_{\{i,j\} \in \chi_{S,\delta}} u_{ij}^{\alpha_{ij}} \omega_{S,\delta} ,$$

along the divisors at infinity in $\overline{\mathfrak{M}}_{0,S}$. Using this formula we retrieve a result, due to Goncharov and Manin, which gives the singular locus of a certain family of forms which correspond directly to multiple zeta values. Our method exploits the action of the symmetric group on $\mathfrak{M}_{0,S}$, and completely avoids the delicate calculation of blow-ups and the cancellation of singularities studied in [G-M]. In §7.5, we show how functorial maps

$$f : \mathfrak{M}_{0,S} \longrightarrow \mathfrak{M}_{0,T_1} \times \mathfrak{M}_{0,T_2} ,$$

where T_1 and T_2 satisfy certain conditions (§2.7), give rise to generalised product formulae between multiple zeta values. More precisely, given any such map f , there is a set of dihedral structures G_f on S such that the following formula holds:

$$(1.13) \quad \int_{X_{T_1,\delta_1}} \omega_1 \times \int_{X_{T_2,\delta_2}} \omega_2 = \sum_{\gamma \in G_f} \int_{X_{S,\gamma}} f^*(\omega_1 \otimes \omega_2) .$$

This expresses a product of periods as a \mathbb{Q} -linear combination of other periods. We compute two explicit examples of such maps f ; one where G_f is as large as possible, and the other when G_f reduces to a single element. In the first case, G_f is the set of (p, q) shuffles where $p = \dim \mathfrak{M}_{0,T_1}$ and $q = \dim \mathfrak{M}_{0,T_2}$, and (1.13) gives rise to the shuffle product for multiple zeta values. In the second case, we show that (1.13), on applying an identity due to Cartier, gives rise to the stuffle relations for multiple zeta values. Thus both shuffle and stuffle relations can be regarded as two extreme cases of generalised product relations of geometric origin on moduli spaces.

The above results are put together in section 8, where we give a proof of theorem 1.1 using Stokes' formula as described above. We summarise the main points of the argument here. The regularisation results of section 6 provide the existence of a graded algebra of multi-valued functions $L(\mathfrak{M}_{0,S})$ with the following properties:

- (1) The graded part of weight 0 of $L(\mathfrak{M}_{0,S})$ consists of all regular algebraic functions on $\mathfrak{M}_{0,S}$ with coefficients in \mathbb{Q} .
- (2) Primitives of ℓ -forms exist in $L(\mathfrak{M}_{0,S})$, and increase the weight by one.
- (3) The restriction of a function $f \in L(\mathfrak{M}_{0,S})$ to a face of $\overline{X}_{S,\delta}$ is a product of multiple zeta values with functions in $L(\mathfrak{M}_{0,T_1})L(\mathfrak{M}_{0,T_2})$.

The argument for computing the period integrals is then by an inductive application of Stokes' theorem over the associahedron $\overline{X}_{S,\delta}$. At each stage, we must compute

$$I = \int_{\overline{X}_{S,\delta}} f \omega_{S,\delta} ,$$

where $f \in L(\mathfrak{M}_{0,S})$ is a function which is allowed logarithmic singularities along the boundary $\partial \overline{X}_{S,\delta}$, but which has no polar singularities. Such an integral necessarily converges, and it follows from property (2) that there exists a primitive F with

coefficients in $L(\mathfrak{M}_{0,S})$ such that $dF = f$. However, such primitives are not unique, and we may inadvertently have introduced extra poles. We show, however, that there exists a primitive F with no poles along $\overline{X}_{S,\delta}$, and it then follows that F extends continuously to the boundary $\partial\overline{X}_{S,\delta}$. The essential remark is that the one-form

$$\log x \, dx \quad \text{where } x \geq 0 ,$$

has a logarithmic singularity at the point $x = 0$, but that its primitive $x \log x - x$ extends continuously to the point 0. We can therefore restrict the primitive F to the faces of the associahedron by property (3), and proceed by induction using Stokes' formula and (1.6) without any further difficulty. In §8.5 we show how the same strategy can be used to compute all relative periods of moduli spaces $\mathfrak{M}_{0,S}$, and finish with some simple examples in §8.6. The paper is completely self-contained, apart from some properties of iterated integrals which are very clearly presented in [Ha1], and some remarks on framed motives in §7.2.

We expect that the ideas and methods introduced in this paper should have applications in the following situations. First of all, one can consider more general hyperplane configurations associated to other root systems or Coxeter groups, and consider the corresponding polylogarithm algebras, periods and associators. Notably, one can introduce N^{th} roots of unity to obtain a tower of spaces over $\mathbb{P}^1 \setminus \{0, e^{2i\pi k/N}, \infty\}$ which are finite covers of $\mathfrak{M}_{0,S}$ and construct a similar theory giving a higher dimensional version of [Ra, D-G]. Furthermore, in perturbative quantum field theory, it is generally believed that certain renormalised period integrals one derives from a large class of Feynman diagrams should give multiple zeta values. After blowing up, these are integrals of rational algebraic forms over algebraic convex polytopes. It would be very interesting to try to apply the methods of this paper to such integrals.

This paper was written during my doctoral thesis at the university of Bordeaux. I am very grateful to Richard Hain for his many detailed comments regarding an earlier version of this manuscript, and especially to Pierre Cartier, without whose many suggestions, good humour, and continuous encouragement, this paper would not have reached its present form.

2. DIHEDRAL COORDINATES ON $\overline{\mathfrak{M}}_{0,n}(\mathbb{R})$.

2.1. Let $n \geq 4$, and let S denote a set with n elements. Let $\mathfrak{M}_{0,S}$ denote the moduli space of Riemann spheres with n points labelled with elements of S . If $(\mathbb{P}^1)_*^S$ denotes the set of all n -tuples of distinct points $z_s \in \mathbb{P}^1$, for $s \in S$, then

$$\mathfrak{M}_{0,S} = \mathrm{PSL}_2 \backslash (\mathbb{P}^1)_*^S ,$$

where PSL_2 is the algebraic group of automorphisms of \mathbb{P}^1 and acts by Möbius transformations. The quotient $\mathfrak{M}_{0,S}$ is an affine variety of dimension $\ell = n - 3$. A point in $\mathfrak{M}_{0,S}(\mathbb{C})$ is therefore an injective map $S \hookrightarrow \mathbb{P}^1(\mathbb{C})$ considered up to the action of $\mathrm{PSL}_2(\mathbb{C})$. If $S = \{s_1, \dots, s_n\}$, then we frequently write i instead of s_i , and denote $\mathfrak{M}_{0,S}$ by $\mathfrak{M}_{0,n}$.

We wish to write down the set of regular functions on $\mathfrak{M}_{0,S}$, or, equivalently, the set of PSL_2 -invariant regular functions on $(\mathbb{P}^1)_*^n$. Let i, j, k, l denote any distinct indices in S . Recall that the cross-ratio is defined by the formula:

$$[ij | kl] = \frac{(z_i - z_k)(z_j - z_l)}{(z_i - z_l)(z_j - z_k)} .$$

The cross-ratios do not depend on the choice of coordinates z_i and are PSL_2 -invariant. We therefore have a set of maps $[ij | kl] : \mathfrak{M}_{0,S} \rightarrow \mathfrak{M}_{0,4} \cong \mathbb{P}^1 \setminus \{0, 1, \infty\}$. The symmetric group on four letters \mathfrak{S}_4 acts on each cross-ratio via the group of anharmonic substitutions $\langle z \mapsto 1 - z, z \mapsto 1/z \rangle \cong \mathfrak{S}_3 \cong \mathfrak{S}_4/V$, where V is the Vierergruppe. We have:

$$(2.1) \quad [ij | kl] = 1 - [ik | jl] , \quad \text{and} \quad [ij | lk] = [ij | kl]^{-1} = [ji | kl] ,$$

$$\text{and} \quad [ij | kl] = [kl | ij] = [ji | lk] = [lk | ji] .$$

For any five distinct indices $i, j, k, l, m \in S$ there is also the multiplicative relation:

$$(2.2) \quad [ij | kl] = [ij | km] \cdot [ij | ml] .$$

In order to make explicit computations, it will be convenient to fix a system of coordinates on $\mathfrak{M}_{0,S}$ from the beginning. This breaks the symmetry, so we assume here that $S = \{1, \dots, n\}$. Since the action of $\mathrm{PSL}_2(\mathbb{C})$ is triply transitive on $\mathbb{P}^1(\mathbb{C})$, we can place the coordinates z_1 at 1, z_2 at ∞ , and z_3 at 0. We define explicit *simplicial coordinates* t_1, \dots, t_ℓ on $\mathfrak{M}_{0,S}$ by setting

$$t_1 = z_4 , \dots , t_\ell = z_n .$$

This identifies $\mathfrak{M}_{0,S}$ with the complement of the affine hyperplane configuration:

$$(2.3) \quad \mathfrak{M}_{0,S} \cong \{(t_1, \dots, t_\ell) \in \mathbb{A}^\ell : t_i \notin \{0, 1\}, \quad t_i \neq t_j \text{ for all } i \neq j\} .$$

If we now perform the change of variables

$$(2.4) \quad t_1 = x_1 \dots x_\ell , \quad t_2 = x_2 \dots x_\ell , \quad \dots , \quad t_\ell = x_\ell ,$$

then we can identify $\mathfrak{M}_{0,S}$ with the open complement of hyperboloids:

$$(2.5) \quad \mathfrak{M}_{0,S} \cong \{(x_1, \dots, x_\ell) \in \mathbb{A}^\ell : x_i \notin \{0, 1\}, \quad x_i \dots x_j \neq 1 \text{ for all } i < j\} .$$

The coordinates x_1, \dots, x_ℓ will be referred to as *cubical coordinates* and are well-suited to the study of polylogarithms on $\mathfrak{M}_{0,S}$ (§6). Simplicial and cubical coordinates are two extremal cases of more general systems of coordinates which we define in an invariant manner in §2.7. We shall pass freely between the two systems, especially when making comparisons with formulae existing in the literature. The

change of coordinates (2.4) has the effect of blowing up the origin; the boundary divisors at the origin in (2.5) cross normally, but do not in (2.3).

2.2. Dihedral coordinates on $\mathfrak{M}_{0,S}$. Let S be a finite set with $n \geq 4$ elements.

Definition 2.1. A *cyclic structure* γ on S is a cyclic ordering of the elements of S , or equivalently, an identification of the elements of S with the edges of an oriented n -gon modulo rotations. A *dihedral structure* δ on S is an identification with the edges of an unoriented n -gon modulo dihedral symmetries.

When we write $S = \{s_1, \dots, s_n\}$, it will carry the obvious dihedral structure unless stated otherwise. In this case, the group of permutations \mathfrak{S}_S can be identified with the symmetric group \mathfrak{S}_n . The set of cyclic (resp. dihedral) structures on S is then indexed by the set of cosets \mathfrak{S}_n/C_n (resp. \mathfrak{S}_n/D_{2n}), where C_n and D_{2n} denote the cyclic and dihedral groups of orders n and $2n$ respectively. We will often represent a dihedral structure as a regular n -gon (S, δ) with edges labelled $1, 2, \dots, n$ in order. A number in parentheses (i) , where $i \in \mathbb{Z}/n\mathbb{Z}$, will denote the pair of adjacent edges $\{i, i+1\}$. We will represent this on the n -gon (S, δ) by labelling the vertices with the elements $(1), (2), \dots, (n)$; the convention is that the vertex labelled (i) meets the edges labelled i and $i+1$ modulo n (figures 2 and 3).

Given a dihedral structure δ on S , we define coordinates on $\mathfrak{M}_{0,S}$ using a certain subset of the set of all cross-ratios as follows. Let $\chi_{S,\delta}$ denote the set of all $n(n-3)/2$ unordered pairs $\{i, j\}$, $1 \leq i, j \leq n$ such that $i, j, i+1, j+1$ are distinct modulo n (i.e., i, j are not consecutive modulo n). Each element $\{i, j\} \in \chi_{S,\delta}$ will be depicted as a chord joining the vertices i and j in the regular n -gon (fig. 2). We set

$$(2.6) \quad u_{ij} = [i \ i+1 \ | \ j+1 \ j] \quad \text{for each} \quad \{i, j\} \in \chi_{S,\delta} .$$

Using the definition of the cross ratio, one can check that u_{ij} is symmetric in i and j , and is therefore well-defined. The set of cross-ratios $\{u_{ij} : \{i, j\} \in \chi_{S,\delta}\}$ only depends on δ . Consequently, we obtain a regular morphism

$$(2.7) \quad (u_{ij})_{\{i,j\} \in \chi_{S,\delta}} : \mathfrak{M}_{0,S} \longrightarrow \mathfrak{M}_{0,4}^{n(n-3)/2} \subset \mathbb{A}^{n(n-3)/2} .$$

A simple calculation in simplicial coordinates shows that

$$(2.8) \quad t_1 = u_{24} \dots u_{2n} , \quad \dots , \quad t_{\ell-1} = u_{2n-1} u_{2n} , \quad t_\ell = u_{2n} ,$$

$$1 - t_1 = u_{13} , \quad 1 - t_2 = u_{13} u_{14} , \quad \dots , \quad 1 - t_\ell = u_{13} \dots u_{1n-1} .$$

Likewise, the set of cubical coordinates $(x_1, \dots, x_\ell) = (u_{24}, \dots, u_{2n})$ are completely determined by the functions u_{ij} , and therefore (2.7) is an embedding. It follows that every cross-ratio can be written in terms of the functions u_{ij} , $\{i, j\} \in \chi_{S,\delta}$.

Lemma 2.2. *Let i, j, k, l be distinct indices modulo n in dihedral order. Then*

$$[ij \ | \ kl] = \prod_{a=i}^{j-1} \prod_{b=k}^{l-1} u_{ab}^{-1} .$$

Using (2.1), we can write any cross-ratio as a product of u_{ab} or their inverses.

Proof. Suppose first that $1 \leq i < j < k < l \leq n$. Using the definition of u_{ab} ,

$$u_{ak} \dots u_{al-1} = [a \ a+1 \ | \ k+1 \ k] [a \ a+1 \ | \ k+2 \ k+1] \dots [a \ a+1 \ | \ l-1] = [a \ a+1 \ | \ lk] ,$$

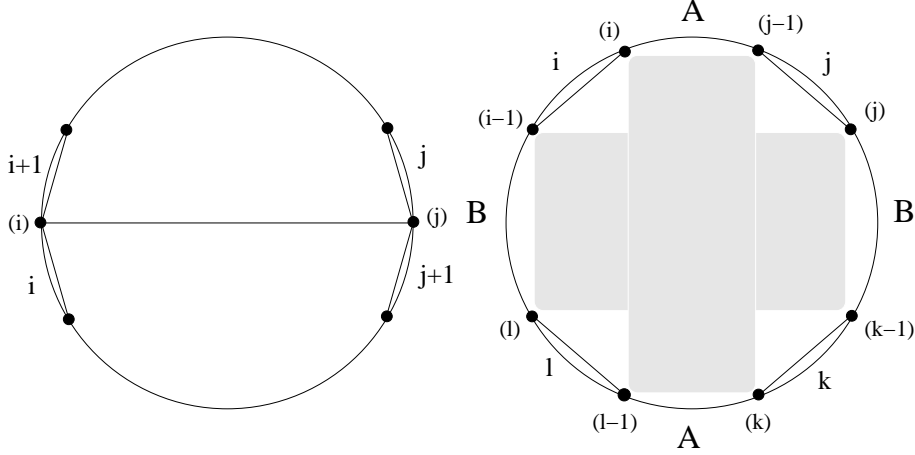

FIGURE 2. Part of an oriented regular n -gon inscribed in a circle. Its edges are labelled with the elements of S , and its vertices are labelled with elements of S in parentheses. Left - a chord $\{i, j\} \in \chi_{S, \delta}$ meets four edges $i, i+1, j, j+1$ which define the dihedral coordinate $u_{ij} = [i \ i+1 \ | \ j+1 \ j]$. Changing the orientation of the n -gon does not alter u_{ij} by the last equation in (2.1). Right - a set of four edges i, j, k, l breaks the n -gon into four regions as in lemma 2.2, and defines a pair $A, B \subset \chi_{S, \delta}$ of completely crossing chords, depicted by the shaded rectangles (corollary 2.3).

by repeated application of (2.2). Likewise, using (2.1) and (2.2),

$$\prod_{a=i}^{j-1} \prod_{b=k}^{l-1} u_{ab} = [i \ i+1 \ | \ l \ k] [i+1 \ i+2 \ | \ l \ k] \dots [j-1 \ j \ | \ k+1 \ k] = [ij \ | \ lk].$$

The formula is clearly invariant under cyclic rotations. Therefore, given any four indices i, j, k, l in arbitrary position, we can reduce to this case by applying the inversion (2.1), which allows us to interchange i, j , or k, l or both pairs $(i, j), (k, l)$. \square

It follows from invariant theory that every PSL_2 -invariant regular function on $(\mathbb{P}^1)_*^n$ is a polynomial in the cross-ratios $[ij \ | \ kl]$. We deduce from lemma 2.2 that the ring of regular functions on $\mathfrak{M}_{0, S}$ is

$$(2.9) \quad \mathcal{O}(\mathfrak{M}_{0, S}) = \mathbb{Q} \left[u_{ij}, \frac{1}{u_{ij}} : \{i, j\} \in \chi_{S, \delta} \right].$$

We can write down a generating set for all algebraic relations between the coordinates u_{ij} in a dihedrally-invariant manner. Consider any chord $\{i, j\} \in \chi_{S, \delta}$. Then the set S (considered as vertices) with the elements i and j removed $S \setminus \{i, j\}$ is partitioned into two connected pieces S_1 and S_2 . We say that two chords $\{i, j\}$ and $\{k, l\} \in \chi_{S, \delta}$ *cross* if and only if $k \in S_1$ and $l \in S_2$. We write this

$$\{i, j\} \sim_x \{k, l\}.$$

Given a subset $A \subset \chi_{S, \delta}$, let A^\times denote the set of chords in $\chi_{S, \delta}$ which cross every chord in A . We say that two sets $A, B \subset \chi_{S, \delta}$ *cross completely* if $A^\times = B$ and

$B^* = A$, i.e.,

$$a \in A \Leftrightarrow a \sim_x b \quad \text{for all } b \in B ,$$

and vice versa (fig. 2). If, for example, A is the single chord $\{i, j\}$, and B is the set of all chords crossing $\{i, j\}$, then A and B cross completely.

Corollary 2.3. *For every two sets of chords $A, B \subset \chi_{S, \delta}$ which cross completely,*

$$(2.10) \quad u_A + u_B = 1 ,$$

where $u_A = \prod_{a \in A} u_a$ and $u_B = \prod_{b \in B} u_b$.

Proof. One can verify that A and B cross completely if and only if there exist four elements $\{i, j, k, l\} \subset S$ in dihedral order (fig. 2) such that

$$\begin{aligned} A &= \{ \{p, q\} \in \chi_{S, \delta} : i \leq p < j \quad \text{and} \quad k \leq q < l \} , \\ B &= \{ \{p, q\} \in \chi_{S, \delta} : j \leq p < k \quad \text{and} \quad l \leq q < i \} . \end{aligned}$$

By lemma 2.2 and (2.1), $u_A = [ij|kl]^{-1} = [ij|lk]$. Likewise, $u_B = [li|jk]^{-1} = [il|jk]$. It follows that $u_A + u_B = [ij|lk] + [il|jk] = 1$ by (2.2). \square

Definition 2.4. Let $I_{S, \delta}^X \subset \mathbb{Z}[u_{ij}]$ denote the ideal generated by the identities (2.10). Let the *dihedral extension* $\mathfrak{M}_{0, S}^\delta$ of $\mathfrak{M}_{0, S}$ be the affine scheme

$$(2.11) \quad \mathfrak{M}_{0, S}^\delta = \text{Spec } \mathbb{Z}[u_{ij} : \{i, j\} \in \chi_{S, \delta}] / I_{S, \delta}^X .$$

By lemma 2.2, we could also define $\mathfrak{M}_{0, S}^\delta$ as follows:

$$(2.12) \quad \mathfrak{M}_{0, S}^\delta = \text{Spec } \mathbb{Z}[[ij|lk], \text{ where } i, j, k, l \in S \text{ are in dihedral order}] / I_{S, \delta} ,$$

where $I_{S, \delta}$ is the ideal generated by the identities $[ij|lk] + [il|jk] = 1$ and (2.2).

Let $i_\delta : \mathfrak{M}_{0, S} \hookrightarrow \mathfrak{M}_{0, S}^\delta$ denote the embedding obtained from (2.7).

Lemma 2.5. *The scheme $\mathfrak{M}_{0, S}^\delta$ is the Zariski closure of the image of $\mathfrak{M}_{0, S}$ in the affine space $\mathbb{A}^{n(n-3)/2}$. In particular, it is of dimension ℓ .*

Proof. By (2.8), the dihedral coordinates u_{24}, \dots, u_{2n} are equal to the cubical coordinates x_1, \dots, x_ℓ respectively. Therefore, $i_\delta(\mathfrak{M}_{0, S})$ is contained in $\{u_{24}, \dots, u_{2n} \neq 0\}$. It follows using dihedral symmetry that $i_\delta(\mathfrak{M}_{0, S}) \subset \{u_{ij} \neq 0 : \{i, j\} \in \chi_{S, \delta}\}$. Using (2.10), we can write x_i , $1 - x_i$, and $1 - x_i \dots x_j$ as a product of dihedral coordinates u_{ab} . This implies that

$$i_\delta(\mathfrak{M}_{0, S}) = \{u_{ij} \neq 0 : \{i, j\} \in \chi_{S, \delta}\} \subset \mathfrak{M}_{0, S}^\delta .$$

By (2.5), each divisor $\{x_i = 0\} = \{u_{2i+3} = 0\}$ is in the closure of $\mathfrak{M}_{0, S}$. Dihedral symmetry implies that $\{u_{ab} = 0\}$ is in the closure of $\mathfrak{M}_{0, S}$ for all $\{a, b\} \in \chi_{S, \delta}$. \square

The complement $\mathfrak{M}_{0, S}^\delta \setminus i_\delta(\mathfrak{M}_{0, S})$ is therefore a union of divisors

$$D_{ij} \subset \mathfrak{M}_{0, S}^\delta , \quad \text{for each } \{i, j\} \in \chi_{S, \delta} ,$$

where D_{ij} is defined by the equation $u_{ij} = 0$. In order to describe the configuration of the divisors D_{ij} , consider cutting the regular n -gon along the chord $\{i, j\}$ joining vertices i and j . This partitions the set of *edges* of S into two sets S_1 and S_2 and breaks the n -gon into two smaller polygons. Their sets of edges are $S_1 \cup \{e\}$ and

$S_2 \cup \{e\}$, where e is the new edge given by the chord $\{i, j\}$ (fig. 3). Each set inherits a dihedral structure δ_k for $k = 1, 2$, and $\chi_{S, \delta}$ is a disjoint union:

$$(2.13) \quad \chi_{S, \delta} = \chi_{S_1 \cup \{e\}, \delta_1} \sqcup \chi_{S_2 \cup \{e\}, \delta_2} \sqcup \{i, j\} \sqcup \bigcup_{\{k, l\} \sim^* \{i, j\}} \{k, l\} .$$

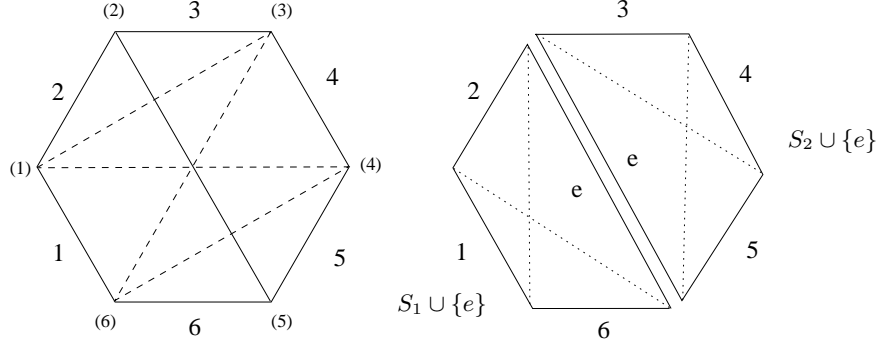

FIGURE 3. Decomposition of the hexagon on setting $u_{25} = 0$. The variables corresponding to chords which cross $\{2, 5\}$, namely u_{13} , u_{46} , u_{14} , u_{36} , are all equal to 1 (left). The system (2.10) splits into the pair of equations, $u_{15} = 1 - u_{26}$ and $u_{35} = 1 - u_{24}$, which identifies D_{25} with $\mathfrak{M}_{0,4}^{\delta} \times \mathfrak{M}_{0,4}^{\delta}$.

Lemma 2.6. *The decomposition (2.13) gives a canonical isomorphism*

$$D_{ij} \cong \mathfrak{M}_{0, S_1 \cup \{e\}}^{\delta_1} \times \mathfrak{M}_{0, S_2 \cup \{e\}}^{\delta_2} .$$

Proof. Equations (2.10) imply in particular that

$$(2.14) \quad u_{ab} + \prod_{\{c, d\} \sim^* \{a, b\}} u_{cd} = 1 \quad \text{for all } \{a, b\} \in \chi_{S, \delta} .$$

Therefore, setting $u_{ij} = 0$ implies that $u_{kl} = 1$ for all chords $\{k, l\}$ which cross $\{i, j\}$. The system of equations (2.10) then decomposes into two disjoint sets, each one containing all variables u_{ab} , where $\{a, b\} \in \chi_{S_1 \cup \{e\}, \delta_1}$, or $\chi_{S_2 \cup \{e\}, \delta_2}$ respectively. To see this, consider the equation

$$(2.15) \quad u_A + u_B = 1 ,$$

where $A, B \subset \chi_{S, \delta}$ cross completely, and where we write $u_I = \prod_{i \in I} u_i$ for any subset $I \subset \chi_{S, \delta}$. Consider the decomposition (2.13) above, and set $A_i = A \cap \chi_{S_i \cup \{e\}, \delta_i}$ for $i = 1, 2$. It follows from the calculation above that, since $u_{ij} = 0$,

$$(2.16) \quad u_A = \begin{cases} 0 & \text{if } \{i, j\} \in A , \\ u_{A_1} u_{A_2} & \text{otherwise.} \end{cases}$$

A similar formula holds for u_B . The picture below depicts the three possible cases which can occur, up to exchanging i, j or A, B . If neither A_1 nor A_2 is empty, the set A contains chords on either side of the chord $\{i, j\}$ (case I). It follows that $\{i, j\} \in A$, and therefore $u_A = 0$. Since $B = A^*$, it follows that $B \subset \{i, j\}^*$, and so $u_{kl} = 1$ for all $\{k, l\} \in B$. Thus (2.15) reduces to $0 + 1 = 1$. Therefore we

can assume without loss of generality that $A_1 = \emptyset$ (see cases II and III), and so $u_A = u_{A_2}$ by (2.16). It is clear that $B_1 = \emptyset$, and so $u_B = u_{B_2}$.

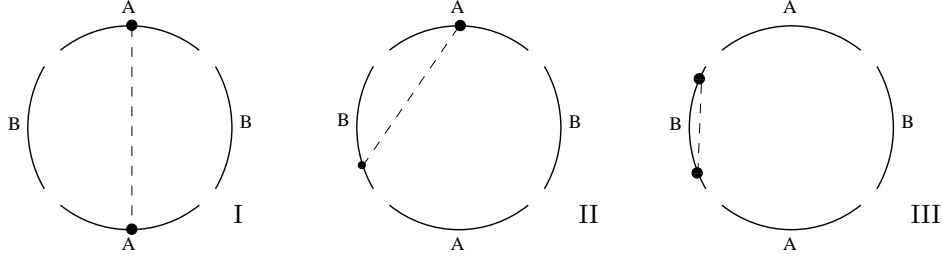

It follows that equation (2.15) reduces to $u_{A_2} + u_{B_2} = 1$, which is a defining equation for $\mathfrak{M}_{0, S_2 \cup \{e\}}^{\delta_2}$. All pairs of completely crossing sets in each smaller polygon $S_k \cup \{e\}$, for $k = 1, 2$, arise in this way. This proves the result. \square

It follows from the proof of the lemma that D_{ij} and D_{kl} have non-empty intersection if and only if the chords $\{i, j\}$ and $\{k, l\}$ do not cross. By (2.14), u_{ij} and u_{kl} cannot simultaneously be zero if $\{i, j\} \sim_x \{k, l\}$. We are therefore led to consider partial decompositions of the n -gon (S, δ) by k non-crossing chords.

Definition 2.7. For each integer $1 \leq k \leq \ell$, let $\chi_{S, \delta}^k$ denote the set of k distinct chords $\alpha = \{\{i_1, j_1\}, \dots, \{i_k, j_k\}\}$ in the n -gon (S, δ) , such that no pair of chords in α cross. For each such $\alpha \in \chi_{S, \delta}^k$, let D_α denote the subvariety defined by the equations $u_{i_1 j_1} = \dots = u_{i_k j_k} = 0$, i.e., $D_\alpha = \bigcap_{m=1}^k D_{i_m j_m}$.

It follows by induction using the previous lemma that the codimension of D_α , for $\alpha \in \chi_{S, \delta}^k$, is exactly k , and that every codimension- k intersection of divisors D_{ij} arises in this manner. Any set of k chords $\alpha \in \chi_{S, \delta}^k$ splits the polygon into $k + 1$ pieces, and we have:

$$(2.17) \quad D_\alpha \cong \prod_{m=1}^{k+1} \mathfrak{M}_{0, S_m}^{\delta_m},$$

where (S_m, δ_m) are given by the set of all edges of each small polygon in the k -decomposition α , with the induced dihedral structures (fig. 4).

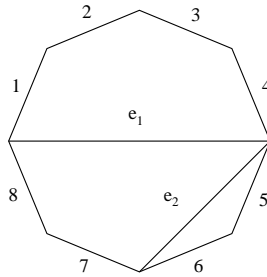

FIGURE 4. A partial decomposition $\alpha \in \chi_{8, \delta}^2$ of an octagon gives an isomorphism of D_α with $\mathfrak{M}_{0,5}^{\delta_1} \times \mathfrak{M}_{0,4}^{\delta_2} \times \mathfrak{M}_{0,3}^{\delta_3} = \mathfrak{M}_{0,5}^{\delta_1} \times \mathbb{A}^1 \times \{\text{pt}\}$.

Remark 2.8. The set of all polygons equipped with the operation of glueing sides together forms what is known as the mosaic operad [Dev1]. This says that, given two polygons with edges labelled $S_1 \cup \{e\}$ and $S_2 \cup \{e\}$ respectively, there is an operation of glueing along the common edge e , which gives rise to a map

$$\chi_{S_1 \cup \{e\}, \delta_1}^k \times \chi_{S_2 \cup \{e\}, \delta_2}^l \rightarrow \chi_{S_1 \cup S_2, \delta}^{k+l+1}.$$

This corresponds to the decomposition of lemma 2.6.

2.3. Forgetful maps between moduli spaces and projections. Let T denote any subset of S such that $|T| \geq 3$. There is a natural map

$$(2.18) \quad f_T : \mathfrak{M}_{0,S} \rightarrow \mathfrak{M}_{0,T}$$

obtained by forgetting the marked points of S which do not lie in T . Now suppose that S has dihedral structure δ . Then T inherits a dihedral structure which we denote δ_T . If we view S as the set of edges of the n -gon (S, δ) , we obtain a map:

$$f_T : \chi_{S, \delta} \rightarrow \chi_{T, \delta_T}$$

which contracts all edges in $S \setminus T$ and combines the corresponding chords (fig. 5).

Lemma 2.9. *The map (2.18) extends to give a map $f_T : \mathfrak{M}_{0,S}^\delta \rightarrow \mathfrak{M}_{0,T}^{\delta_T}$ such that*

$$(2.19) \quad f_T^*(u_{kl}) = \prod_{\{a,b\} \in f_T^{-1}(\{k,l\})} u_{ab}.$$

Proof. By (2.12), f_T^* is induced by the map:

$$f_T^* : \mathbb{Z}[[i|j|l|k] : i, j, k, l \in T^{\delta_T}] / I_{T, \delta_T} \hookrightarrow \mathbb{Z}[[i|j|l|k] : i, j, k, l \in S^\delta] / I_{S, \delta},$$

where $i, j, k, l \in T^{\delta_T}$ (resp. S^δ) denotes four elements in T (resp. S) in dihedral order. Formula (2.19) follows immediately from lemma 2.2. \square

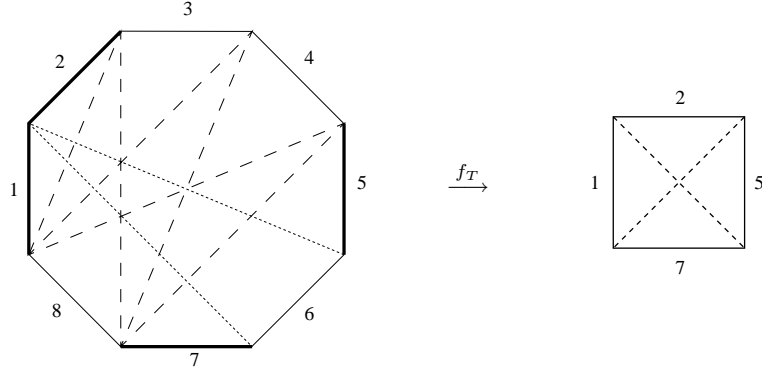

FIGURE 5. The forgetful map f_T contracts edges labelled 3, 4, 6, 8. The dihedral coordinates corresponding to the two chords in the square are pulled back by f_T^* to $u_{15}u_{16}$ and $u_{27}u_{37}u_{47}u_{28}u_{38}u_{48}$.

Remark 2.10. If $\{i, j\} \in \chi_{S, \delta}$, let T denote the four element set $T = \{i, i+1, j, j+1\}$. Then the dihedral coordinate u_{ij} is by definition a forgetful map:

$$\mathfrak{M}_{0,S}^\delta \xrightarrow{f_T} \mathfrak{M}_{0,T}^{\delta_T} \cong \mathbb{A}^1.$$

If T_1, T_2 are two subset of S such that $|T_1 \cap T_2| \geq 3$, we obtain a map

$$(2.20) \quad f_{T_1} \times f_{T_2} : \mathfrak{M}_{0,S}^\delta \longrightarrow \mathfrak{M}_{0,T_1}^{\delta_1} \times_{\mathfrak{M}_{0,T_1 \cap T_2}^{\delta'}} \mathfrak{M}_{0,T_2}^{\delta_2},$$

where $\delta_1 = \delta_{T_1}$, $\delta_2 = \delta_{T_2}$, and $\delta' = \delta_{T_1 \cap T_2}$.

We now consider what happens when $|T_1 \cap T_2| = 2$. Suppose that the elements of T_k are consecutive with respect to δ , for $k = 1, 2$. Then two cases can occur: either $T_1 \cap T_2$ consists of two consecutive elements $\{i, i+1\}$ where $i \in S$, or $T_1 \cap T_2$ has two components and $T_1 \cap T_2 = \{a, b\}$, where $a, b \in S$ are non-consecutive. We only consider the first case here. This corresponds to choosing a directed chord $\{i, j\} \in \chi_{S,\delta}$, and cutting along it. Let S_1 and S_2 denote the corresponding partition of the set S viewed as edges of the n -gon (fig. 3), and consider the larger overlapping sets defined by $T_1 = S_1 \cup \{i, i+1\}$ and $T_2 = S_2 \cup \{i, i+1\}$.

A product of forgetful maps gives

$$(2.21) \quad f_{T_1} \times f_{T_2} : \mathfrak{M}_{0,S}^\delta \longrightarrow \mathfrak{M}_{0,T_1}^{\delta_1} \times \mathfrak{M}_{0,T_2}^{\delta_2}.$$

The dimension of the product on the right hand side is $(|T_1| - 3) + (|T_2| - 3)$, which is $\ell - 1$, one less than on the left. Suppose that the chord $\{i, j\} = \{i, i+2\}$ is short. In that case, one of the sets, say T_2 , has just three elements, and $\mathfrak{M}_{0,T_2}^{\delta_2}$ reduces to a point. The complement $S \setminus T_1$ is a single point. We write $S = \{s_1, \dots, s_n\}$, and let $\{s_n\} = S \setminus T_1$. In that case, the restriction of f_{T_1} to $\mathfrak{M}_{0,S}$:

$$f_{T_1} : \mathfrak{M}_{0,\{s_1, \dots, s_n\}} \rightarrow \mathfrak{M}_{0,\{s_1, \dots, s_{n-1}\}}$$

is a fibration with one-dimensional fibres which are isomorphic to the punctured projective line $\mathbb{P}^1 \setminus \{s_1, \dots, s_{n-1}\}$. In general, the restriction of the map (2.21) to the open set $\mathfrak{M}_{0,S}$ is not a fibration, but almost. Let us compute it in cubical coordinates. By applying a dihedral symmetry, we can assume $i = 2$. By (2.8), we have $u_{2j} = x_m$, where $m = j - 3$. One verifies that

$$\begin{aligned} \mathfrak{M}_{0,T_1} &= \{(x_1, \dots, x_{m-1}) : x_i \notin \{0, 1\}, \quad x_i \dots x_j \neq 1 \text{ for } i < j\}, \\ \mathfrak{M}_{0,T_2} &= \{(x_{m+1}, \dots, x_\ell) : x_i \notin \{0, 1\}, \quad x_i \dots x_j \neq 1 \text{ for } i < j\}, \end{aligned}$$

and the map $f_{T_1} \times f_{T_2} : \mathfrak{M}_{0,S} \rightarrow \mathfrak{M}_{0,T_1} \times \mathfrak{M}_{0,T_2}$ is just projection onto $x_m = 0$:

$$f_{T_1} \times f_{T_2} : (x_1, \dots, x_\ell) \mapsto ((x_1, \dots, x_{m-1}), (x_{m+1}, \dots, x_\ell)).$$

We can therefore think of (2.21) as a coordinate projection in cubical coordinates. Referring to figure 10, we see that in $\mathfrak{M}_{0,6}$ there are two such types of map, one given by projection onto $\mathfrak{M}_{0,5}$ (set $x_1 = 0$ or $x_3 = 0$), and the other given by projection onto $\mathfrak{M}_{0,4} \times \mathfrak{M}_{0,4}$ (set $x_2 = 0$). Restricting (2.21) to the divisor $u_{ij} = 0$, we retrieve the isomorphism $D_{ij} \cong \mathfrak{M}_{0,T_1}^{\delta_1} \times \mathfrak{M}_{0,T_2}^{\delta_2}$ which was defined in lemma 2.6.

Remark 2.11. One can make the map $f_{T_1} \times f_{T_2} : \mathfrak{M}_{0,S} \rightarrow \mathfrak{M}_{0,T_1} \times \mathfrak{M}_{0,T_2}$ into a fibration by restricting it to an open subset $U_S \subset \mathfrak{M}_{0,S}$. One obtains a map $f_{T_1} \times f_{T_2} : U_S \rightarrow V_S$, where $V_S \subset \mathfrak{M}_{0,T_1} \times \mathfrak{M}_{0,T_2}$, whose fibers are isomorphic to \mathbb{A}^1 with N points removed. The N removed points correspond to the set of chords $\{k, l\}$ which cross $\{i, j\}$, plus the chord $\{i, j\}$ itself.

For example, consider the case $\mathfrak{M}_{0,6}$, where we write the cubical coordinates (x_1, x_2, x_3) as (x, y, z) . Then $U_S = \{(x, y, z) \in \mathfrak{M}_{0,6} : x \neq z\}$, and $V_S = \{(x, z) \in \mathbb{C}^2 : x, z \neq 0, 1 : x \neq z^{\pm 1}\}$. Then the fibration map $(x, y, z) \mapsto (x, z) : U_S \rightarrow V_S$ has fibers $\{y \in \mathbb{C} : y \notin \{0, 1, x^{-1}, z^{-1}, (xz)^{-1}\}\}$. The removed points in the fiber are given by the five equations $u_{25} = 0, u_{13} = u_{14} = u_{36} = u_{46} = 1$ (see figure 3).

2.4. Normal vertex coordinates on $\mathfrak{M}_{0,S}(\mathbb{C})$. We wish to show that $\mathfrak{M}_{0,S}^\delta$ is smooth and that $\mathfrak{M}_{0,S}^\delta \setminus \mathfrak{M}_{0,S}$ is normal crossing. In order to do this, we construct normal coordinates in the neighbourhood of each subvariety D_α , for $\alpha \in \chi_{S,\delta}^k$. We first consider two further relations satisfied by the dihedral coordinates u_{ij} on $\mathfrak{M}_{0,S}$.

We frequently use the following notation: for any two sets $I, J \subset S$, we write

$$(2.22) \quad u_{IJ} = \prod_{i \in I, j \in J} u_{ij} .$$

Also, given two consecutive indices $i, i+1$ modulo n , we adopt the convention that $u_{i i+1} = 0$. This is compatible with the decomposition of lemma 2.6: after cutting along a chord $\{i, j\} \in \chi_{S,\delta}$, the vertices i and j become adjacent in each small polygon, and indeed, $u_{ij} = 0$ is the equation of the corresponding divisor (fig. 4).

Lemma 2.12. *Let $\{p, q\} \in \chi_{S,\delta}$. Then any three of the four coordinates u_{pq} , $u_{p q+1}$, $u_{p+1 q}$, $u_{p+1 q+1}$ determine the fourth, and we have the butterfly relation on $\mathfrak{M}_{0,S}$:*

$$(2.23) \quad \frac{u_{pq}(1 - u_{p q+1})}{1 - u_{pq}u_{p q+1}} = \frac{1 - u_{p+1 q+1}}{1 - u_{p+1 q+1}u_{p+1 q}} ,$$

where $u_{p+1 q} = 0$ ($u_{p q+1} = 0$) if $p+1$ and q , (respectively $q+1$, p) are consecutive.

Proof. Let A and B be the subsets of vertices S pictured in the diagram below (left). Then (2.10) implies the following equations:

$$\begin{aligned} 1 - u_{p q+1} &= u_{A p+1} u_{AB} u_{A q} , \\ 1 - u_{p q} u_{p q+1} &= u_{A p+1} u_{AB} , \\ 1 - u_{p+1 q+1} &= u_{p B} u_{AB} u_{A q} u_{p q} , \\ 1 - u_{p+1 q+1} u_{p+1 q} &= u_{p B} u_{AB} . \end{aligned}$$

Identity (2.23) follows by substitution. \square

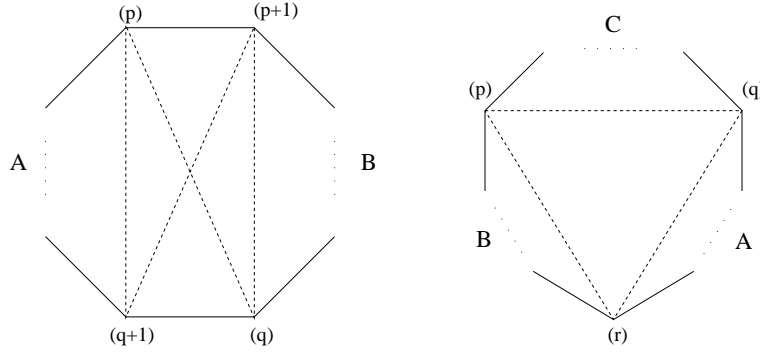

FIGURE 6. Proof of the butterfly (left) and triangle relation (right).

Lemma 2.13. *Let p, q, r denote three non-consecutive elements of S , and set $\pi_r = \prod_{p < i < q} u_{ir}$. Then the triangle relation holds on $\mathfrak{M}_{0,S}$:*

$$(2.24) \quad \frac{1 - u_{pq}}{(1 - u_{pr})(1 - u_{qr})} = \frac{\pi_r}{(1 - \pi_r u_{pr})(1 - \pi_r u_{qr})} .$$

If we regard this as a quadratic equation for π_r in $\mathbb{Q}(u_{pq}, u_{pr}, u_{qr})$, then the discriminant is non-zero in a Zariski-open neighbourhood of $u_{pr} = u_{qr} = u_{pq} = 0$.

Proof. Let A , B and C be the subsets of vertices S pictured in the diagram above (right). Then (2.10) implies the following equations:

$$\begin{aligned} 1 - u_{pq} &= u_{BC} \pi_r u_{AC} , \\ 1 - u_{pr} &= u_{BC} u_{Bq} u_{AB} , \\ 1 - u_{qr} &= u_{AC} u_{Ap} u_{AB} , \\ 1 - u_{pr} \pi_r &= u_{Bq} u_{AB} , \\ 1 - u_{qr} \pi_r &= u_{Ap} u_{AB} . \end{aligned}$$

The identity (2.24) follows by substitution. One verifies by straightforward computation that the discriminant of (2.24) is

$$(2.25) \quad \Delta_{p,q,r} = (1 - u_{pq}u_{qr} + u_{qr}u_{rp} - u_{pr}u_{pq})^2 - 4(1 - u_{pq})^2 u_{pr}u_{qr} ,$$

from which the last statement follows. \square

Let $\alpha \in \chi_{S,\delta}^\ell$ denote a triangulation of the n -gon (S, δ) . An *internal triangle* of α is a triple $p, q, r \in S$ such that p, q, r are non-adjacent, and $\{p, q\}$, $\{p, r\}$, and $\{q, r\}$ are in α . A *free vertex* of α is a vertex $i \in S$ such that $\{i, k\} \notin \alpha$ for all $\{i, k\} \in \chi_{S,\delta}$. If t denotes the number of internal triangles in α , and v denotes the number of free vertices in α , then it is easy to show that $v = 2 + t$. A triangulation of the n -gon has no internal triangles if and only if it has exactly two free vertices.

Definition 2.14. Let $\alpha \in \chi_{S,\delta}^\ell$, and choose an ordering on the set of chords $\{i_1, j_1\}, \dots, \{i_\ell, j_\ell\}$ in α . Then the set of *vertex coordinates*¹ corresponding to the ordered triangulation α is the set of variables:

$$x_1^\alpha, \dots, x_\ell^\alpha ,$$

defined by setting $x_k^\alpha = u_{i_k j_k}$ for $1 \leq k \leq \ell$.

If $\alpha = \{\{2, 4\}, \dots, \{2, n\}\}$ with the natural ordering, then $x_k^\alpha = x_k = u_{2k+3}$ for $1 \leq k \leq \ell$, and we retrieve the cubical coordinates defined in (2.5) as a special case.

Let $\{i, j\} \in \chi_{S,\delta}$. Recall from (2.13) that there is a decomposition

$$\chi_{S,\delta} = \chi' \sqcup \{i, j\} \sqcup \bigcup_{\{k,l\} \sim_* \{i,j\}} \{k, l\} ,$$

where χ' consists of all chords $\{a, b\}$ which do not cross $\{i, j\}$. The following lemma states that we can eliminate all dihedral coordinates u_{kl} , where $\{k, l\}$ crosses $\{i, j\}$.

Lemma 2.15. *Let $\{i, j\} \in \alpha$. On the open set $\mathfrak{M}_{0,S}^\delta \setminus \{u_{ij} = 1\}$, every variable u_{kl} , where $\{k, l\} \in \chi_{S,\delta}$ crosses $\{i, j\}$, can be expressed as a rational function of u_{ij} , and the variables u_{ab} where $\{a, b\} \in \chi'$.*

¹The reason for this terminology will become apparent in §2.5. A triangulation α corresponds to the point D_α which is a vertex (corner) of the Stasheff polytope $X_{S,\delta} \subset \mathfrak{M}_{0,S}^\delta(\mathbb{R})$ (see fig. 10).

Proof. The easiest way to see this is on the example $\alpha \in \chi_{8,\delta}^5$ depicted in figure 7 (left), where $\{i, j\} = \{1, 5\}$. Consider the following equations given by (2.10):

$$\begin{aligned} u_{28} &= 1 - u_{17}u_{16}u_{15}u_{14}u_{13} , \\ u_{28}u_{27} &= 1 - u_{16}u_{15}u_{14}u_{13} , \\ u_{28}u_{27}u_{26} &= 1 - u_{15}u_{14}u_{13} , \\ u_{38}u_{28} &= 1 - u_{17}u_{16}u_{15}u_{14} , \\ u_{38}u_{37}u_{28}u_{27} &= 1 - u_{16}u_{15}u_{14} , \\ u_{38}u_{37}u_{36}u_{28}u_{27}u_{26} &= 1 - u_{15}u_{14} , \\ &\dots \end{aligned}$$

The identities (2.10) imply that

$$1 - u_{ij} = \prod_{\{k,l\} \sim_x \{i,j\}} u_{kl} ,$$

and therefore all the variables on the left hand side in the equations above are invertible on $\mathfrak{M}_{0,S}^\delta \setminus \{u_{ij} = 1\}$. All the variables on the right hand side lie in $\chi' \cup \{i, j\}$. We can therefore solve for $u_{28}, u_{27}, u_{26}, u_{38}, u_{37}, u_{36}$ and so on, in turn. The general case is similar. \square

Let $\{i, j\} \in \chi_{S,\delta}$ denote a chord. Then $\{i, j\}$ partitions the set of edges of (S, δ) into two sets, S_1 and S_2 . The chord itself corresponds to the four edges $E = \{i, i+1, j, j+1\}$. The sets $T_1 = S_1 \cup E$, and $T_2 = S_2 \cup E$ overlap in precisely the set E , and therefore $|T_1 \cap T_2| = 4$. Let δ_E denote the induced dihedral structure on E . By definition of the dihedral coordinate u_{ij} , there is an isomorphism $u_{ij} : \mathfrak{M}_{0,E}^{\delta_E} \cong \mathbb{A}^1$. Therefore (2.20) defines a map:

$$(2.26) \quad \mathfrak{M}_{0,S}^\delta \longrightarrow \mathfrak{M}_{0,T_1}^{\delta_1} \times_{\mathbb{A}^1} \mathfrak{M}_{0,T_2}^{\delta_2} .$$

The chord $\{i, j\}$ is in both χ_{T_1,δ_1} and χ_{T_2,δ_2} (fig. 7).

Proposition 2.16. *The map (2.26) defines an embedding*

$$(2.27) \quad \mathfrak{M}_{0,S}^\delta \setminus \{u_{ij} = 1\} \hookrightarrow \mathfrak{M}_{0,T_1}^{\delta_1} \setminus \{u_{ij} = 1\} \times_{\mathbb{A}^1 \setminus \{1\}} \mathfrak{M}_{0,T_2}^{\delta_2} \setminus \{u_{ij} = 1\} .$$

Proof. The map $(f_{T_1} \times f_{T_2})^*$ is given by:

$$\begin{aligned} \mathbb{Z}[[i|j|l|k] : i, j, k, l \in T_1^{\delta_1}] / I_{T_1,\delta_1} \otimes_{\mathbb{Z}[[u_{ij}]]} \mathbb{Z}[[i|j|l|k] : i, j, k, l \in T_2^{\delta_2}] / I_{T_2,\delta_2} \\ \longrightarrow \mathbb{Z}[[i|j|l|k] : i, j, k, l \in S^\delta] / I_{S,\delta} , \end{aligned}$$

with the notation used in the proof of lemma 2.9. It can also be regarded as a map:

$$\begin{aligned} \mathbb{Z}[u_{ab} : \{a, b\} \in \chi_{T_1,\delta_1}] / I_{T_1,\delta_1}^X \otimes_{\mathbb{Z}[[u_{ij}]]} \mathbb{Z}[u_{ab} : \{a, b\} \in \chi_{T_2,\delta_2}] / I_{T_2,\delta_2}^X \\ \longrightarrow \mathbb{Z}[u_{ab} : \{a, b\} \in \chi_{S,\delta}] / I_{S,\delta}^X , \end{aligned}$$

The previous lemma implies that the map $(f_{T_1} \times f_{T_2})^*$ is surjective when we invert the coordinates u_{kl} such that $\{k, l\}$ crosses $\{i, j\}$, *i.e.*, on the open set $u_{ij} \neq 1$. \square

Each set of vertex coordinates defines an étale map on a certain Zariski-open subset obtained by iterating the map in the previous proposition. Let $\alpha \in \chi_{S,\delta}^k$ denote any partial k -decomposition of the n -gon and define:

$$(2.28) \quad U_\alpha = \bigcap_{\{i,j\} \in \alpha} \{u_{ij} \neq 1\} \subset \mathfrak{M}_{0,S}^\delta .$$

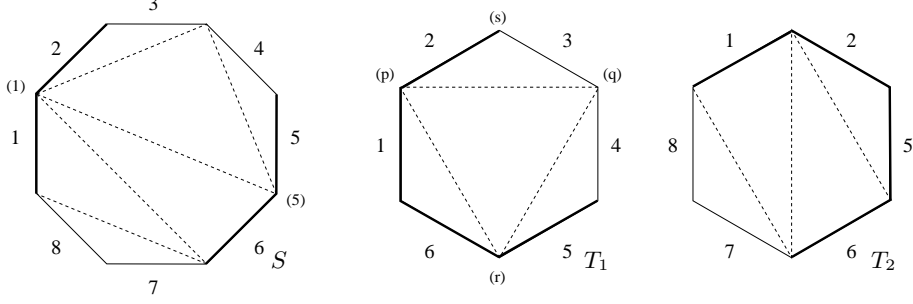

FIGURE 7. The induction step in the proof of proposition 2.18. The chord $\{1, 5\}$ in the octagon on the left distinguishes the four thick edges $E = \{1, 2, 5, 6\}$. The two sets $T_1 = \{1, 2, 3, 4, 5, 6\}$ and $T_2 = \{5, 6, 7, 8, 1, 2\}$ intersect in E and define the hexagons on the right. The right hand hexagon can be further decomposed into a pair of pentagons, but the middle hexagon has an internal triangle, so we have to invoke the triangle lemma.

Since $D_\alpha = \{u_{ij} = 0 : \text{for } \{i, j\} \in \alpha\}$, it follows that $D_\alpha \subset U_\alpha$, and U_α is an open neighbourhood of the subvariety D_α which contains the open set $\mathfrak{M}_{0,S}$.

Now let $\{i, j\} \in \alpha$, and consider the map (2.27). We obtain two decompositions α_1, α_2 , and Zariski-open sets $U_{\alpha_1}, U_{\alpha_2}$ on T_1, T_2 respectively.

Remark 2.17. The embedding (2.27) extends the isomorphism $D_\alpha \cong D_{\alpha_1} \times D_{\alpha_2}$. The product structure on each boundary stratum of $\mathfrak{M}_{0,S}^\delta$ therefore extends over a Zariski-open subset of the variety.

Now for each $\alpha \in \chi_{S,\delta}^k$, we define a Zariski-open set

$$(2.29) \quad U'_\alpha = \bigcap_{\{p,q,r\} \in \alpha} \{\Delta_{pq,r} \neq 0\} \cap U_\alpha \subset \mathfrak{M}_{0,S}^\delta,$$

where the intersection is over all sets of (ordered) internal triangles $\{p, q, r\} \in \alpha$ and $\Delta_{pq,r}$ is defined by (2.25). It follows from (2.25) that $D_\alpha \subset U'_\alpha$.

Proposition 2.18. *Let $\alpha \in \chi_{S,\delta}^\ell$ denote any ordered triangulation of the n -gon (S, δ) . The set of vertex coordinates $\{x_1^\alpha, \dots, x_\ell^\alpha\}$ defines a map*

$$(x_1^\alpha, \dots, x_\ell^\alpha) : U'_\alpha \longrightarrow \mathbb{A}^\ell$$

which is étale. It therefore defines a system of coordinates on $U'_\alpha(\mathbb{R})$ or $U'_\alpha(\mathbb{C})$.

Proof. By iterating the decomposition (2.27), we obtain an embedding

$$(2.30) \quad U_\alpha \hookrightarrow \prod_{i=1}^N U_{\alpha_i},$$

where each α_i is a triangulation of a k_i -gon which cannot be decomposed any further. We can assume that each decomposition is strict, *i.e.*, $k_i \geq 5$ for each i .

Two cases can occur. If there are no internal triangles, then necessarily $k_i = 5$, and we can assume that $x_1^{\alpha_i} = u_{13}$, and $x_2^{\alpha_i} = u_{14}$. In that case, (2.10) gives:

$$u_{25} = 1 - u_{13}u_{14}, \quad u_{24}u_{25} = 1 - u_{13}, \quad \text{and} \quad u_{35}u_{25} = 1 - u_{14}.$$

The variables on the left are invertible on $U_{\alpha_i} = \{u_{25} \neq 0\} \cap \{u_{24} \neq 0\} \cap \{u_{35} \neq 0\}$, so it follows that $x_1^{\alpha_i}, x_2^{\alpha_i}$ is a coordinate system on this open set, *i.e.*, the map

$$(x_1^{\alpha_i}, x_2^{\alpha_i}) : U_{\alpha_i} \longrightarrow \mathbb{A}^2$$

is injective, and certainly étale. On the other hand, if there is an internal triangle $\{p, q, r\}$, and the k_i -gon cannot be decomposed any further, then we are in the situation corresponding to $\mathfrak{M}_{0,6}$ pictured above (fig. 6, middle). By symmetry, we can assume that $x_1^{\alpha_i} = u_{13}$, $x_2^{\alpha_i} = u_{15}$, and $x_3^{\alpha_i} = u_{35}$. By equation (2.24), the variable $\pi_r = u_{25}$ depends quadratically on $x_1^{\alpha_i}, x_2^{\alpha_i}, x_3^{\alpha_i}$. It follows from the triangle lemma (2.13) and the definition of U'_{α_i} that the map

$$(x_1^{\alpha_i}, x_2^{\alpha_i}, x_3^{\alpha_i}) : U'_{\alpha_i} \longrightarrow \mathbb{A}^3$$

is étale. It is in fact two to one. This is because all remaining dihedral coordinates u_{ij} are uniquely determined by $x_1^{\alpha_i} = u_{15}$, $\pi_r = u_{25}$, and $x_3^{\alpha_i} = u_{35}$ by applying the relation (2.10) and inverting coordinates which do not vanish on U'_{α_i} in much the same way as above. From (2.30) we obtain an embedding $U'_\alpha \hookrightarrow \prod_{i=1}^N U'_{\alpha_i}$, which in turn gives rise to a commutative diagram

$$\begin{array}{ccc} U'_\alpha & \xrightarrow{(x_1^\alpha, \dots, x_\ell^\alpha)} & \mathbb{A}^\ell \\ \downarrow & & \downarrow \\ \prod_{i=1}^N U'_{\alpha_i} & \xrightarrow{\prod_{i=1}^N (x_1^{\alpha_i}, \dots, x_{k_i}^{\alpha_i})} & \prod_{i=1}^N \mathbb{A}^{k_i} \end{array}$$

The vertical maps on the left and on the right are diagonal embeddings. We have shown that the horizontal map along the bottom is étale. It follows that the horizontal map along the top is étale, which completes the proof. \square

If the triangulation α contains no internal triangles, then $U'_\alpha = U_\alpha$, and the functions $x_1^\alpha, \dots, x_\ell^\alpha$ give an isomorphism of $\mathfrak{M}_{0,S}$ with a Zariski open subset of \mathbb{A}^ℓ .

Corollary 2.19. *Let $\alpha \in \chi_{S,\delta}^\ell$, such that α has no internal triangles (and therefore two free vertices). Then the set $x_1^\alpha, \dots, x_\ell^\alpha$ is a system of coordinates everywhere on $\mathfrak{M}_{0,S}$, and every cross-ratio u_{ij} is a \mathbb{Q} -rational function of the x_i^α .*

We could also define $\mathfrak{M}_{0,S}^\delta$ using the set of equations (2.23). One can verify that if $\alpha \in \chi_{S,\delta}^\ell$ has no internal triangles, then all dihedral coordinates can be expressed in terms of the vertex coordinates $\{x_i^\alpha\}$ by repeatedly applying the butterfly lemma.

Lemma 2.20. *The sets U'_α , for $\alpha \in \chi_{S,\delta}^\ell$, cover $\mathfrak{M}_{0,S}^\delta$.*

Proof. For each partial decomposition $\beta \in \chi_{S,\delta}^k$, set

$$N_\beta = \{u_{ij} = 0 \text{ for all } \{i, j\} \in \beta\} \cap \{u_{pq} \neq 0 \text{ for all } \{p, q\} \notin \beta\},$$

which is an open subset of $D_\beta = \{u_{ij} = 0 \text{ for all } \{i, j\} \in \beta\}$. It follows immediately from this definition that $\mathfrak{M}_{0,S}^\delta$ decomposes as a disjoint union:

$$(2.31) \quad \mathfrak{M}_{0,S}^\delta = \mathfrak{M}_{0,S} \cup \bigcup_{k=1}^{\ell} \bigcup_{\beta \in \chi_{S,\delta}^k} N_\beta.$$

Let $\beta \in \chi_{S,\delta}^k$ denote any partial decomposition of the n -gon (S, δ) . By adding chords, we can find a complete triangulation $\alpha \in \chi_{S,\delta}^\ell$ which contains β , without creating any new internal triangles in α . It follows from (2.25) and lemma 2.13

that $N_\beta \subset U'_\alpha$. Note that if β is the empty triangulation, then $\mathfrak{M}_{0,S} \subset U'_\alpha$ for any α which has no internal triangles. The decomposition (2.31) then implies that

$$\mathfrak{M}_{0,S}^\delta \subset \bigcup_{\alpha \in \chi_{S,\delta}^\ell} U'_\alpha .$$

□

Theorem 2.21. *The affine variety $\mathfrak{M}_{0,S}^\delta$ is smooth, and the divisors D_{ij} , for $\{i, j\} \in \chi_{S,\delta}$, are smooth and normal crossing.*

Proof. Let $\alpha \in \chi_{S,\delta}^\ell$. Proposition 2.18 states that the vertex coordinates $x_1^\alpha, \dots, x_\ell^\alpha$ corresponding to α define an étale map $U'_\alpha \rightarrow \mathbb{A}^\ell$. The image of $\mathfrak{M}_{0,S} \cap U'_\alpha$ in U'_α is precisely the complement of the normal crossing divisor

$$x_1^\alpha \dots x_\ell^\alpha = 0$$

(see fig. 8). The theorem follows since the sets U'_α cover $\mathfrak{M}_{0,S}^\delta$. □

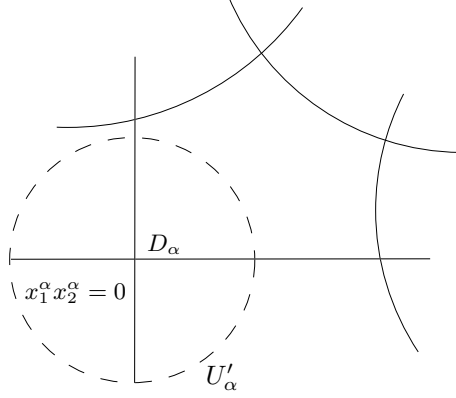

FIGURE 8. The covering of $\mathfrak{M}_{0,5}^\delta$. To each vertex $\alpha \in \chi_{S,\delta}^\ell$, there is an open set U'_α on which the set of vertex coordinates $\{x_i^\alpha\}$ cross normally. The sets U'_α form a covering, which implies that the divisors D_{ij} are smooth and normal crossing.

2.5. The real moduli space $\mathfrak{M}_{0,S}^\delta(\mathbb{R})$. Consider the moduli space of projective circles with n ordered marked points:

$$\mathfrak{M}_{0,S}(\mathbb{R}) = \mathrm{PSL}_2(\mathbb{R}) \backslash \mathbb{P}^1(\mathbb{R})_*^n .$$

The space $\mathfrak{M}_{0,S}(\mathbb{R})$ is not connected, but is a disjoint union of open cells which we define as follows. First, we fix a dihedral structure δ on S , which defines a set of dihedral coordinates u_{ij} for $\{i, j\} \in \chi_{S,\delta}$. Let

$$(2.32) \quad \overline{X}_{S,\delta} = \{u_{ij} \geq 0 : \{i, j\} \in \chi_{S,\delta}\} \subset \mathfrak{M}_{0,S}^\delta(\mathbb{R}) .$$

By (2.10), $\overline{X}_{S,\delta}$ is also defined by the equations $0 \leq u_{ij} \leq 1$ for all $\{i, j\} \in \chi_{S,\delta}$, and is therefore compact. We define the open cell $X_{S,\delta}$ to be the interior of $\overline{X}_{S,\delta}$:

$$(2.33) \quad X_{S,\delta} = \overline{X}_{S,\delta} \cap \mathfrak{M}_{0,S} = \{u_{ij} > 0 : \{i, j\} \in \chi_{S,\delta}\} .$$

The sets $X_{S,\delta}$ and $\overline{X}_{S,\delta}$ are clearly preserved by the dihedral symmetries of δ , so there is an action of the dihedral group $D_{2n} \times \overline{X}_{S,\delta} \rightarrow \overline{X}_{S,\delta}$. Using explicit simplicial coordinates (2.8), one checks that the open set $X_{S,\delta}$ is homeomorphic to the simplex

$$(2.34) \quad X_{S,\delta} \cong \{(t_1, \dots, t_\ell) \quad : \quad 0 < t_1 < \dots < t_\ell < 1\} .$$

It follows that $X_{S,\delta}$ is contractible, and moreover, that $X_{S,\delta}$ is a connected component of $\mathfrak{M}_{0,S}(\mathbb{R})$. After changing to cubical coordinates, we see that $X_{S,\delta}$ is the unit hypercube $\{(x_1, \dots, x_\ell) : x_i \in (0, 1)\} = (0, 1)^\ell$, which explains the nomenclature of each coordinate system (fig. 9).

Each cell $X_{S,\delta}$ consists of the set of points $s_1, \dots, s_n \in \mathbb{P}^1(\mathbb{R})$ such that s_1, \dots, s_n are in the dihedral order determined by δ . Two components $X_{S,\delta}, X_{S,\delta'}$ are disjoint if δ and δ' are distinct, and the set of dihedral structures are permuted transitively by the symmetric group \mathfrak{S}_n . This implies the following tiling lemma. Devadoss has studied the exact glueing relations between the cells $X_{S,\delta}$ in this tiling [Dev1].

Lemma 2.22. *The space $\mathfrak{M}_{0,S}(\mathbb{R})$ is the disjoint union of the $n!/2n$ open cells $X_{S,\delta}$, as $\delta \in \mathfrak{S}_n/D_{2n}$ ranges over the set of all dihedral structures on S .*

It is now clear that the choice of a dihedral structure δ on S is equivalent to the choice of a fundamental cell $X_{S,\delta} \in \pi_0(\mathfrak{M}_{0,S}(\mathbb{R})) \cong \mathfrak{S}_n/D_{2n}$. The set of dihedral coordinates u_{ij} corresponding to δ can be regarded as a natural set of functions which is stable under the action of the symmetry group of $X_{S,\delta}$.

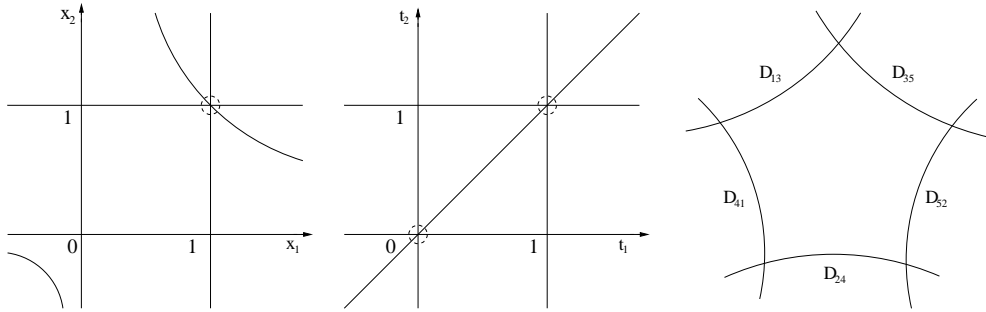

FIGURE 9. The set of real points $\mathfrak{M}_{0,5}(\mathbb{R})$ in cubical (left), simplicial (middle), and dihedral coordinates (right). The dotted circles denote points which are blown up when passing to dihedral coordinates. There are $5!/10=12$ regions $X_{S,\delta}$ when $|S| = 5$.

Definition 2.23. For each chord $\{i, j\} \in \chi_{S,\delta}$, we define the face $F_{ij}(\overline{X}_{S,\delta})$ of $\overline{X}_{S,\delta}$ to be the closed subset $F_{ij}(\overline{X}_{S,\delta}) = D_{ij} \cap \overline{X}_{S,\delta} \subset \mathfrak{M}_{0,S}^\delta(\mathbb{R})$. Likewise, for each $\alpha \in \chi_{S,\delta}^k$, we define the codimension- k face of $\overline{X}_{S,\delta}$ to be $F_\alpha(\overline{X}_{S,\delta}) = D_\alpha \cap \overline{X}_{S,\delta}$.

It follows from lemma 2.5 that

$$(2.35) \quad F_{ij}(\overline{X}_{S,\delta}) \cong \overline{X}_{T_1 \cup \{e\}, \delta_1} \times \overline{X}_{T_2 \cup \{e\}, \delta_2} ,$$

where $T_1 \cup T_2$ is the partition of (the set of edges) S corresponding to the chord $e = \{i, j\}$. By equation (2.17), each codimension- k face $F_\alpha(\overline{X}_{S,\delta})$ is a product

$$F_\alpha(\overline{X}_{S,\delta}) \cong \prod_{m=1}^{k+1} \overline{X}_{S_m, \delta_m} .$$

By repeatedly taking boundaries we obtain a stratification:

$$(2.36) \quad \overline{X}_{S,\delta} \supseteq \partial \overline{X}_{S,\delta} \supseteq \partial^2 \overline{X}_{S,\delta} \supseteq \dots \supseteq \partial^\ell \overline{X}_{S,\delta} ,$$

where the codimension- k boundary of $\overline{X}_{S,\delta}$ is the union of its codimension- k faces:

$$\partial^k \overline{X}_{S,\delta} = \bigcup_{\alpha \in \chi_{S,\delta}^k} F_\alpha(\overline{X}_{S,\delta}) \quad \text{for } 1 \leq k \leq \ell .$$

For each $n \geq 4$, the associahedron K_{n-1} , or Stasheff polytope [St], is a convex polytope of dimension $n - 3$ whose codimension- k faces are indexed by the partially ordered set of compatible bracketings on a set of $n - 1$ elements.

Corollary 2.24. *The lattice of faces $\overline{X}_{S,\delta}$ is combinatorially equivalent to the associahedron K_{n-1} .*

Proof. The set of all codimension- k faces $F_\alpha(\overline{X}_{S,\delta})$ is indexed by k -triangulations of a regular n -gon, and the inclusion of one face in another is given by removing a chord. By taking the dual graph of a partial triangulation of an n -gon we obtain a planar tree. If we fix an edge s_1 of S , then each such tree is rooted, and defines, in a standard way, a bracketing of the ordered set $\{s_2, \dots, s_n\}$ (fig. 11). We obtain in this way a bijection between faces of $\overline{X}_{S,\delta}$ and bracketings on a set of $n - 1$ elements (this is beautifully illustrated in [Dev2]). \square

Since each face F_α is contractible, we can view $\overline{X}_{S,\delta}$ in the coordinates u_{ij} as a dihedrally-symmetric algebraic model of the associahedron K_{n-1} . The fact that the divisors D_{ij} cross normally implies that the associahedron is a simple polytope, *i.e.*, each vertex is the intersection of exactly ℓ distinct faces.

Remark 2.25. As remarked earlier, $\mathfrak{M}_{0,S}^\delta$ can be obtained by blowing up a set of divisors bounding $X_{S,\delta}$. Since the operation of blowing up is non-commutative, we have to specify that the blow-ups occur along subvarieties in increasing order of dimension. A useful intuitive picture of the polytopes $\overline{X}_{S,\delta}$ can be obtained by blowing up the unit hypercube $[0, 1]^\ell$ along the divisors $x_i = \dots = x_j = 1$ for $1 \leq i < j \leq \ell$. The set of real points in the blow-up can be visualised by truncating the unit hypercube along the hyperboloids $x_i \dots x_j = 1 - \varepsilon$, where $i < j$ for some fixed $\varepsilon > 0$ which is sufficiently small (see fig. 10). Alternatively, one could truncate the simplicial model of $X_{S,\delta}$ to obtain another explicit construction of K_{n-1} (see [Dev2]). This involves a greater number of truncations, however.

2.6. The compactification $\overline{\mathfrak{M}}_{0,S}$ and its divisors at infinity. The set of all cross-ratios defines an embedding:

$$(2.37) \quad \{[i j | k l]\} : \mathfrak{M}_{0,S} \longrightarrow \mathfrak{M}_{0, \{i,j,k,l\}}^{\binom{n}{4}} \cong (\mathbb{P}^1 \setminus \{0, 1, \infty\})^{\binom{n}{4}} .$$

The coordinates $\{[i j | k l]\}$ satisfy identities (2.1) and (2.2). These identities define a projective scheme we denote

$$\overline{\mathfrak{M}}_{0,S} \subset (\mathbb{P}^1)^{\binom{n}{4}} ,$$

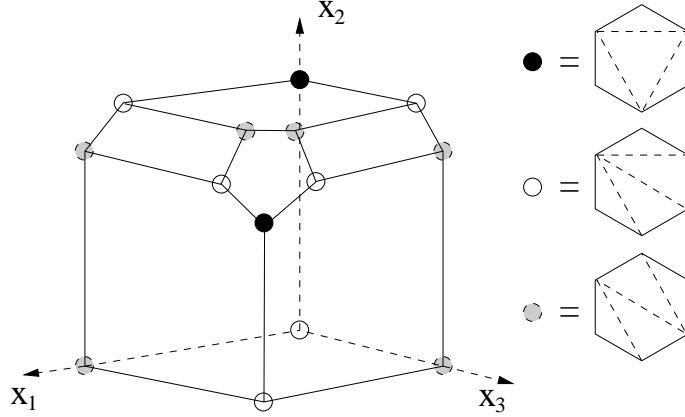

FIGURE 10. The associahedron or Stasheff polytope $\overline{X}_{6,\delta} = K_5$ in $\mathfrak{M}_{0,6}^\delta(\mathbb{R})$ obtained by truncating the unit cube in \mathbb{R}^3 , or blowing up along $x_1 = x_2 = x_3 = 1$, and then $x_1 = x_2 = 1$ and $x_2 = x_3 = 1$. It has six faces $F_{13}, F_{24}, F_{35}, F_{46}, F_{51}, F_{62}$ which are pentagons $\overline{X}_{5,\delta}$, and three faces F_{14}, F_{25}, F_{36} which are quadrilaterals $\overline{X}_{4,\delta_1} \times \overline{X}_{4,\delta_1}$. These are permuted by the group D_{12} . There are three types of vertices corresponding to three kinds of triangulation of a hexagon. The vertex coordinates defined in §2.3 for each triangulation provide local affine charts in the neighbourhood of each vertex.

which is defined over \mathbb{Z} . This representation of $\overline{\mathfrak{M}}_{0,S}$ is degenerate since some coordinates are the same, but it is clearly invariant under the action of the symmetric group. Now for every dihedral structure δ on S , there is an embedding

$$j_\delta : \mathfrak{M}_{0,S}^\delta \rightarrow \overline{\mathfrak{M}}_{0,S}$$

given by lemma 2.1, which expresses every cross ratio $[ij|kl]$ as a product of dihedral coordinates. Letting δ vary, we obtain in this way an affine covering of $\overline{\mathfrak{M}}_{0,S}$.

Lemma 2.26. *The compactification $\overline{\mathfrak{M}}_{0,S}$ is covered by affine charts $\mathfrak{M}_{0,S}^\delta$, as δ ranges over the set of all dihedral structures on S :*

$$(2.38) \quad \overline{\mathfrak{M}}_{0,S} = \bigcup_{\delta \in \mathfrak{S}_n/D_{2n}} j_\delta(\mathfrak{M}_{0,S}^\delta).$$

Proof. The right-hand side is clearly contained in the left. But one can show in a similar manner to the proof of lemma 2.5 that $\mathfrak{M}_{0,S}$ is dense in $\overline{\mathfrak{M}}_{0,S}$ as defined above. The point is that $j_\delta(\mathfrak{M}_{0,S}) \subset \{[ij|kl] \neq 0\} \subset \overline{\mathfrak{M}}_{0,S}$ for all δ . Any cross-ratio $[ij|kl]$ is a dihedral coordinate u_{ab} for some dihedral structure δ_0 . Therefore $[ij|kl] = 0$ is in the closure of $j_{\delta_0}(\mathfrak{M}_{0,S})$ by lemma 2.5. The same holds for the divisors $[ij|kl] = 1, \infty$ by (2.1). This proves that both sides are equal. \square

Theorem (2.21) implies the following corollary.

Corollary 2.27. *$\overline{\mathfrak{M}}_{0,S}$ is smooth and $\overline{\mathfrak{M}}_{0,S} \setminus \mathfrak{M}_{0,S}$ is a normal crossing divisor.*

The irreducible components at infinity of $\overline{\mathfrak{M}}_{0,S} \setminus \mathfrak{M}_{0,S}$ can be described as follows.

Lemma 2.28. *Let δ denote a dihedral structure on S , and let $\{p, q\} \in \chi_{S, \delta}$. The chord $\{p, q\}$ partitions the set S , viewed as edges of the n -gon (S, δ) , into two sets $P_1 \cup P_2$. Then the divisor $j_\delta(D_{pq}) \subset \overline{\mathfrak{M}}_{0, S} \setminus \mathfrak{M}_{0, S}$ is determined by the equations $[i|j|k|l] = 0$ for all distinct indices i, j, k, l such that*

$$\{i, k\} \subset P_1 \text{ and } \{j, l\} \subset P_2 ,$$

$$\text{or } \{j, l\} \subset P_1 \text{ and } \{i, k\} \subset P_2 .$$

Proof. On the chart $j_\delta(\mathfrak{M}_{0, S}^\delta)$, these equations imply in particular that $u_{pq} = 0$, and therefore determine the divisor $j_\delta(D_{pq})$. That the remaining cross-ratios also vanish on $j_\delta(D_{pq})$ follows from lemma 2.2. \square

It follows that two divisors $j_{\delta_1}(D_1)$ and $j_{\delta_2}(D_2)$ coincide on $\overline{\mathfrak{M}}_{0, S} \setminus \mathfrak{M}_{0, S}$ if and only if the corresponding partitions of S agree.

Definition 2.29. A partition $P_1 \cup P_2 = S$ is *stable* if $|P_1| \geq 2$ and $|P_2| \geq 2$. A dihedral structure δ on S is *compatible* with $P_1 \cup P_2$ if the elements of each set P_1 and P_2 are consecutive with respect to δ . A divisor $D \subset \overline{\mathfrak{M}}_{0, S} \setminus \mathfrak{M}_{0, S}$ is said to be *at finite distance* with respect to a dihedral structure δ , if $D \subset j_\delta(\mathfrak{M}_{0, S}^\delta)$.

Observe that $D \subset j_\delta(\mathfrak{M}_{0, S}^\delta)$ if and only if $D \cap j_\delta(\mathfrak{M}_{0, S}^\delta) \neq \emptyset$.

Proposition 2.30. *There is a bijection between the irreducible components of the divisors at infinity of $\overline{\mathfrak{M}}_{0, S} \setminus \mathfrak{M}_{0, S}$, and stable partitions $S = P_1 \cup P_2$. The component D corresponding to this partition is canonically isomorphic to*

$$\overline{\mathfrak{M}}_{0, P_1 \cup \{e\}} \times \overline{\mathfrak{M}}_{0, P_2 \cup \{e\}} ,$$

where e is a symbol. A divisor is at finite distance with respect to a dihedral structure δ if and only if δ is compatible with the corresponding partition of S .

Proof. The bijection between stable partitions and divisors follows immediately from the previous remarks and the covering (2.38). The last statement of the proposition holds by definition. It remains to prove the decomposition. Suppose that we are given a stable partition $S = P_1 \cup P_2$, and let D denote the corresponding divisor. There is a bijection between the set of dihedral structures δ which are compatible with $P_1 \cup P_2$, and the set of induced dihedral structures δ_1, δ_2 on the sets $P_1 \cup \{e\}$ and $P_2 \cup \{e\}$ (compare fig. 3). It follows from lemma 2.6 that:

$$D \cap j_\delta(\mathfrak{M}_{0, S}^\delta) \cong \begin{cases} j_\delta(\mathfrak{M}_{0, P_1 \cup \{e\}}^{\delta_1} \times \mathfrak{M}_{0, P_2 \cup \{e\}}^{\delta_2}) & \text{if } \delta \text{ is compatible with } P_1 \cup P_2 , \\ \emptyset & \text{otherwise .} \end{cases}$$

If we identify $j_\delta(\mathfrak{M}_{0, P_1 \cup \{e\}}^{\delta_1} \times \mathfrak{M}_{0, P_2 \cup \{e\}}^{\delta_2})$ with $j_{\delta_1}(\mathfrak{M}_{0, P_1 \cup \{e\}}^{\delta_1}) \times j_{\delta_2}(\mathfrak{M}_{0, P_2 \cup \{e\}}^{\delta_2})$ in $\overline{\mathfrak{M}}_{0, P_1 \cup \{e\}} \times \overline{\mathfrak{M}}_{0, P_2 \cup \{e\}}$, we obtain:

$$\begin{aligned} D &= D \cap \overline{\mathfrak{M}}_{0, S} = D \cap \bigcup_{\delta} j_\delta(\mathfrak{M}_{0, S}^\delta) \cong \bigcup_{\delta_1, \delta_2} j_\delta(\mathfrak{M}_{0, P_1 \cup \{e\}}^{\delta_1} \times \mathfrak{M}_{0, P_2 \cup \{e\}}^{\delta_2}) \\ &\cong \bigcup_{\delta_1} j_{\delta_1}(\mathfrak{M}_{0, P_1 \cup \{e\}}^{\delta_1}) \times \bigcup_{\delta_2} j_{\delta_2}(\mathfrak{M}_{0, P_2 \cup \{e\}}^{\delta_2}) = \overline{\mathfrak{M}}_{0, P_1 \cup \{e\}} \times \overline{\mathfrak{M}}_{0, P_2 \cup \{e\}} . \end{aligned}$$

\square

We introduce the following notation. Let D denote the divisor given by a stable partition $S = P_1 \cup P_2$. Then for any pair of indices $i, j \in S$, we set

$$(2.39) \quad \mathbb{I}_D(i, j) = \mathbb{I}(\{i, j\} \subset P^1) + \mathbb{I}(\{i, j\} \subset P^2) ,$$

where $\mathbb{I}(A \subset B)$ is the indicator function which takes the value 1 if a set A is contained in B , and 0 otherwise.

Corollary 2.31. *Let D denote the divisor corresponding to the stable partition $S = P_1 \cup P_2$. The order of vanishing of any cross-ratio along D is given by:*

$$\text{ord}_D [ij|kl] = \frac{1}{2} \left[\mathbb{I}_D(i, k) + \mathbb{I}_D(j, l) - \mathbb{I}_D(i, l) - \mathbb{I}_D(j, k) \right] .$$

Proof. The formula is invariant under the action of $\mathfrak{S}(S)$ on divisors and cross-ratios. We can therefore fix a dihedral structure δ on S and assume that $D = D_{2a}$, where $a \in \{4, \dots, n\}$. The formula is also compatible with (2.1) and additive with respect to (2.2). By lemma 2.2, it therefore suffices to verify the formula for $[pp + 1|q + 1q] = u_{pq}$, where $\{p, q\} \in \chi_{S, \delta}$. It follows from (2.10) that $\text{ord}_{D_{2a}} u_{pq}$ is 1 if $\{p, q\} = \{2, a\}$ and is 0 otherwise. The partition corresponding to D_{2a} is $\{3, 4, \dots, a\} \cup \{a + 1, \dots, n, 1\}$, and it is easy to check that the formula holds in this case. \square

A stable partition $S = P_1 \cup P_2$ is conveniently represented as the union of two circles, joined at a point e , with marked points corresponding to P_1 on the first circle, and those corresponding to P_2 on the other. Taking iterated intersections of divisors, one obtains an operad of bubble diagrams (fig. 11) [Dev2]. Such a diagram defines a tree. If we take the dual graph, we obtain a partial decomposition of a polygon. Note that we can find dihedral structures δ for which the labellings of the outer edges are in dihedral order with respect to δ . In this way, any bubble diagram corresponds to an intersection of divisors at finite distance on a certain number of affine pieces $\mathfrak{M}_{0,S}^\delta$ in $\overline{\mathfrak{M}}_{0,S}$.

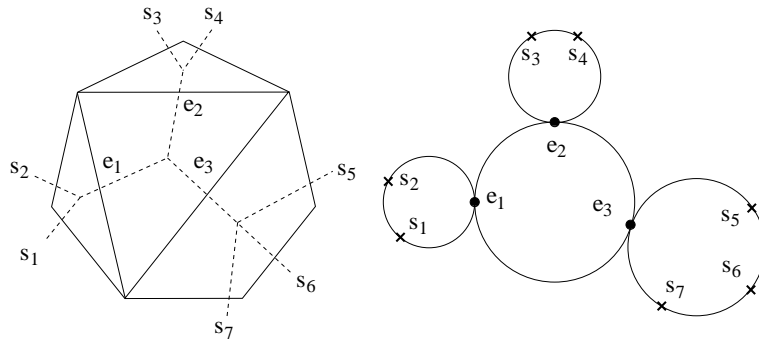

FIGURE 11. A partial decomposition of a heptagon (left), its dual graph (dotted lines), and the corresponding bubble diagram (right). If the tree is rooted at s_1 , this corresponds to the bracketing $(s_2, ((s_3, s_4), (s_5, s_6, s_7)))$.

2.7. Product maps. The projection maps on $\mathfrak{M}_{0,S}$ defined above decrease the dimension by one. We will also need to consider various maps between products of moduli spaces \mathfrak{M}_{0,T_i} which preserve the dimensions. These give rise to special coordinate systems on $\mathfrak{M}_{0,S}$ and will be used to define products on period integrals. Given two subsets $T_1, T_2 \subset S$ such that $|T_i| \geq 4$, we consider maps of the form

$$(2.40) \quad f = f_{T_1} \times f_{T_2} : \mathfrak{M}_{0,S} \longrightarrow \mathfrak{M}_{0,T_1} \times \mathfrak{M}_{0,T_2} .$$

Such a map will be called a *product map* if

$$(2.41) \quad \begin{aligned} |T_1 \cap T_2| &= 3 , \\ S &= T_1 \cup T_2 . \end{aligned}$$

In this case the dimensions on both sides of (2.40) are equal, since the equalities (2.41) imply that $|S| - 3 = |T_1| - 3 + |T_2| - 3$. The map f is an embedding, because we can place the three points in $T_1 \cap T_2$ at $0, 1$, and ∞ , and each remaining marked point $s \in S$ is then uniquely determined by the map f_{T_i} where $i \in \{1, 2\}$ and $s \in T_i$. We can iterate this construction by further decomposing T_i as a union of sets satisfying (2.41). Since the composition of two forgetful maps f_T is itself a forgetful map, we obtain a family of subsets $T_1, \dots, T_k \subset S$ such that $|T_i| \geq 4$, and a map

$$(2.42) \quad f = \prod_{i=1}^k f_{T_i} : \mathfrak{M}_{0,S} \longrightarrow \prod_{i=1}^k \mathfrak{M}_{0,T_i} .$$

This is an embedding by construction. The sets T_i cover S , *i.e.*, $S = \cup_{i=1}^k T_i$, and the equality of dimensions on the left and right hand sides of (2.42) implies that

$$(2.43) \quad |S| + 3(k-1) = \sum_{i=1}^k |T_i| .$$

We can then regard $\mathfrak{M}_{0,S}$ as a dense open subscheme of $\prod_{i=1}^k \mathfrak{M}_{0,T_i}$, and we say that f is a *non-degenerate coordinate system* on $\mathfrak{M}_{0,S}$. Any set of vertex coordinates $\{x_i^\alpha\}$ corresponding to a triangulation $\alpha \in \mathcal{X}_{S,\delta}^\ell$, when α has no internal triangles, is an example of a non-degenerate coordinate system (this can be verified by induction). More precisely, if $x_i^\alpha = u_{p_i, q_i}$, then we can cover S with the sets $T_i = \{p_i, p_i+1, q_i, q_i+1\}$, and identify \mathfrak{M}_{0,T_i} with $\mathbb{P}^1 \setminus \{0, 1, \infty\}$ using the coordinate x_i^α , for $1 \leq i \leq \ell$. If, however, α has internal triangles, then the map f corresponding to the set of vertex coordinates x_i^α is not an embedding, and therefore cannot be a non-degenerate coordinate system.

Let us fix a dihedral structure δ on S . This is equivalent, by §2.5, to choosing one of the open cells $X_{S,\delta}$ which cover $\mathfrak{M}_{0,S}(\mathbb{R})$. This induces a dihedral structure δ_i on each subset $T_i \subset S$, which in turn defines a fundamental cell X_{T_i,δ_i} , for $1 \leq i \leq k$. By construction, $f_{T_i}(X_{S,\delta}) \subset X_{T_i,\delta_i}$, and therefore $f(X_{S,\delta}) \subset \prod_{i=1}^k X_{T_i,\delta_i}$. We define G_f to be the set of all dihedral structures on S which are compatible with the dihedral structures on each T_i induced by δ : *i.e.*,

$$(2.44) \quad G_f = \{\gamma \in \mathfrak{S}(S)/D_{2n} \text{ such that } \gamma|_{T_i} = \delta_i\} .$$

The precise relation between the domains $\prod_i X_{T_i,\delta_i}$ and $X_{S,\delta}$ is given by:

$$(2.45) \quad f^{-1}\left(\prod_{i=1}^k X_{T_i,\delta_i}\right) = \prod_{\gamma \in G_f} X_{S,\gamma} .$$

Any point $x \in X_{S,\gamma}$ maps via f into $\prod_i X_{T_i,\delta_i}$ if and only if $\gamma|_{T_i} = \delta_i$. Identity (2.45) follows because the set of cells $X_{S,\gamma}$, for $\gamma \in \mathfrak{S}(S)/D_{2n}$, cover $\mathfrak{M}_{0,S}(\mathbb{R})$ disjointly, by §2.5.

We consider two examples of such a map f , one for which G_f is trivial, which gives rise to cubical coordinates, and the other for which G_f is as large as possible, which defines simplicial coordinates. We will see later in §7 that these special cases give rise to the stuffle and shuffle relations for multiple zeta values, respectively.

We fix a dihedral structure δ on S , and write $S = \{s_1, \dots, s_n\}$, as usual. Consider first of all the covering $S = \bigcup_{i=4}^n T_i$, where

$$(2.46) \quad T_i = \{s_2, s_3, s_i, s_{i+1}\} \quad \text{for } 4 \leq i \leq n,$$

and all indices are modulo n , as usual. This defines a map

$$(2.47) \quad f_{\square} : \mathfrak{M}_{0,S} \longrightarrow \prod_{i=4}^n \mathfrak{M}_{0,T_i},$$

which satisfies condition (2.43). One verifies without difficulty that this is a non-degenerate coordinate system as defined above (or use the fact that $|T_i \cap T_{i+1}| = 3$ for $4 \leq i \leq n-1$). We call f_{\square} a system of *cubical coordinates* on $\mathfrak{M}_{0,S}$. In this case, $G_{f_{\square}}$ is trivial, since if γ is a dihedral structure on S compatible with all the dihedral structures $s_2 < s_3 < s_i < s_{i+1}$ on T_i (or $s_2 > s_3 > s_i > s_{i+1}$), then we must have $s_1 < \dots < s_n < s_1$ (or $s_1 > \dots > s_n > s_1$). Each moduli space $\mathfrak{M}_{0,T_i} \cong \mathfrak{M}_{0,4}$ is isomorphic to $\mathbb{P}^1 \setminus \{0, 1, \infty\}$ in six natural ways, corresponding to the six choices of cross-ratio on $\mathfrak{M}_{0,4}$. If we identify \mathfrak{M}_{0,T_i} with $\mathbb{P}^1 \setminus \{0, 1, \infty\}$ using the coordinate $u_{2i} = [2\ 3 | i+1\ i]$, for $4 \leq i \leq n$, then, since $x_{i-3} = u_{2i}$ by (2.8), we retrieve the explicit cubical coordinates defined in §2.1. In other words, (2.47) is just

$$f_{\square} = (x_1, \dots, x_{\ell}) : \mathfrak{M}_{0,S} \rightarrow (\mathbb{A}^1 \setminus \{0, 1\})^{\ell},$$

and coincides with (2.5). Each cell X_{T_i,δ_i} is the unit interval $(0, 1)$ in these coordinates, and $X_{S,\delta}$ maps under f_{\square} to $(0, 1)^{\ell}$. In this case, equation (2.45) simply states that a product of ℓ unit intervals is the unit ℓ -dimensional hypercube.

Cubical coordinates come from a product map. If $k \geq 4$, we set

$$S_1 = \bigcup_{i=4}^k T_i = \{s_2, s_3, \dots, s_{k+1}\} \quad \text{and} \quad S_2 = \bigcup_{i=k+1}^n T_i = \{s_{k+1}, \dots, s_n, s_1, s_2, s_3\}.$$

Setting $m = k - 3$, we define the *cubical product map* m_{\square} to be

$$(2.48) \quad m_{\square} = f_{S_1} \times f_{S_2} : \mathfrak{M}_{0,S} \longrightarrow \mathfrak{M}_{0,S_1} \times \mathfrak{M}_{0,S_2} \\ (x_1, \dots, x_{\ell}) \longmapsto ((x_1, \dots, x_m), (x_{m+1}, \dots, x_{\ell})).$$

Now, the simplicial case arises by considering the covering $S = \bigcup_{i=4}^n T_i$, where

$$(2.49) \quad T_i = \{s_1, s_2, s_3, s_i\} \quad \text{for } 4 \leq i \leq n.$$

This defines a map

$$(2.50) \quad f_{\Delta} : \mathfrak{M}_{0,S} \longrightarrow \prod_{i=4}^n \mathfrak{M}_{0,T_i},$$

which satisfies condition (2.43) and is a non-degenerate coordinate system for the same reasons as above (namely $|T_i \cap T_j| = 3$ for all $i \neq j$). We call f_{Δ} a *system*

of simplicial coordinates on $\mathfrak{M}_{0,S}$. It is easy to check that G_{f_Δ} is bijective to the symmetric group on ℓ letters

$$G_{f_\Delta} = \mathfrak{S}(\{s_4, \dots, s_n\}) .$$

As above, we obtain an explicit set of simplicial coordinates by choosing the coordinate $t_i = [i + 3 \mid 1 \mid 3 \mid 2] : \mathfrak{M}_{0, T_{i+3}} \cong \mathbb{P}^1 \setminus \{0, 1, \infty\}$, for $1 \leq i \leq \ell$. Thus (2.50) can be written

$$f_\Delta = (t_1, \dots, t_\ell) : \mathfrak{M}_{0,S} \rightarrow (\mathbb{A}^1 \setminus \{0, 1\})^\ell ,$$

and we retrieve the isomorphism (2.3). As before, the domains X_{T_i, δ_i} map to unit intervals $(0, 1)$ under t_{i-3} , and $X_{S, \delta}$ maps bijectively under f_Δ to the unit simplex $\{0 < t_1 < \dots < t_\ell < 1\}$. In this case, equation (2.45) states that

$$\prod_{\sigma \in \mathfrak{S}(\{\sigma_4, \dots, \sigma_n\})} f_\Delta(X_{S, \sigma}) = \prod_i X_{T_i} ,$$

i.e., the unit cube $(0, 1)^\ell$ is tessellated with $\ell!$ copies of the unit simplex.

Now let $k \geq 4$, $m = k - 3$, and set

$$S_1 = \bigcup_{i=4}^k T_i = \{s_1, s_2, s_3, \dots, s_{k-1}, s_k\} \quad \text{and} \quad S_2 = \bigcup_{i=k+1}^n T_i = \{s_1, s_2, s_3, s_{k+1}, \dots, s_n\} .$$

We define the *simplicial product map* m_Δ to be

$$(2.51) \quad \begin{aligned} m_\Delta = f_{S_1} \times f_{S_2} : \mathfrak{M}_{0,S} &\longrightarrow \mathfrak{M}_{0,S_1} \times \mathfrak{M}_{0,S_2} \\ (t_1, \dots, t_\ell) &\longmapsto ((t_1, \dots, t_m), (t_{m+1}, \dots, t_\ell)) . \end{aligned}$$

In this case, the set G_{m_Δ} is exactly the set $\mathfrak{S}(m, \ell - m)$ of all possible ways of shuffling together the sets $\{s_4, \dots, s_k\}$ and $\{s_{k+1}, \dots, s_n\}$ whilst preserving the orderings $s_4 < \dots < s_k$ and $s_{k+1} < \dots < s_n$. In explicit simplicial coordinates, which involves setting $s_1 = 1$, $s_2 = \infty$, $s_3 = 0$, and $s_{i+3} = t_i$ for $1 \leq i \leq \ell$, equation (2.45) is the well-known formula for the decomposition of a product of simplices:

$$(2.52) \quad \begin{aligned} \{0 < t_1 < \dots < t_m < 1\} \times \{0 < t_{m+1} < \dots < t_\ell < 1\} &\cong \\ \prod_{\sigma \in \mathfrak{S}(m, \ell - m)} \{0 < t_{\sigma(1)} < \dots < t_{\sigma(\ell)} < 1\} . & \end{aligned}$$

3. THE REDUCED BAR CONSTRUCTION AND PICARD-VESSIOT THEORY

The main tool for computing the periods of moduli spaces is a triviality theorem for the cohomology of a variant of the bar construction on the de Rham complex of $\mathfrak{M}_{0,S}$. Although many of the results below hold in considerably greater generality, we consider the complement of an affine hyperplane arrangement M , which is more than adequate for our purposes. We first show that the reduced bar construction on $\Omega^*(M)$ defines a Picard-Vessiot extension of its ring of regular functions. This is an abstract algebraic analogue of the ring of iterated integrals over M . Then, by showing that the bar construction decomposes as a tensor product over a fibration, we prove that the cohomology of the bar construction is trivial for fiber-type arrangements. This result is also proved for quadratic arrangements in the appendix. Our point of view, using differential Galois theory, is different from classical approaches to this subject [Ha1-2, Ch1-2, Ko]. The main technical idea is the notion of unipotent extensions of differentially simple algebras, which is developed in §3.6. The example $\mathfrak{M}_{0,5}$ is discussed in §3.8.

3.1. Shuffle algebras and non-commutative formal power series. Let R be a commutative unitary ring. Let $k \geq 1$, let $A = \{a_1, \dots, a_k\}$ denote an alphabet with k symbols, and let A^* denote the free non-commutative monoid generated by A , *i.e.*, the set of all words w in the symbols a_i , along with the empty word 1. Let $R\langle A \rangle$ be the free non-commutative R -algebra generated by A . If V_1 is the free R -module with basis $\{a_1, \dots, a_k\}$, and if we set $V_m = V_1^{\otimes m}$ and $V_0 = R$, then clearly

$$R\langle A \rangle = \bigoplus_{m \geq 0} V_m .$$

It is well-known [Bou] that $R\langle A \rangle$ can be given the structure of a cocommutative graded Hopf algebra. The multiplication law on $R\langle A \rangle$ is given by concatenation of words, and the coproduct $\Gamma : R\langle A \rangle \rightarrow R\langle A \rangle \otimes R\langle A \rangle$ is defined to be the unique coproduct for which the elements of A are all primitive:

$$\Gamma(a_i) = a_i \otimes 1 + 1 \otimes a_i .$$

The counit $\varepsilon : R\langle A \rangle \rightarrow R$ is given by projection onto the unit word 1. If $|w|$ denotes the number of symbols occurring in a word $w \in A^*$, then the antipode map is defined by $w \mapsto (-1)^{|w|} \tilde{w}$, where the mirror map $w \mapsto \tilde{w}$ reverses the order of the symbols in each word. One verifies that this defines a graded Hopf algebra structure.

Let V_1^\vee denote the R -module dual to V_1 , and let $A' = \{a'_1, \dots, a'_k\}$ denote the basis dual to A . Then $R\langle A' \rangle$, the free tensor algebra over V_1^\vee , is the graded dual of $R\langle A \rangle$, and inherits a commutative Hopf algebra structure by duality. The multiplication law is now given by the shuffle product $\mathfrak{M} : R\langle A' \rangle \otimes R\langle A' \rangle \rightarrow R\langle A' \rangle$ which is defined recursively by the formulae: $w \mathfrak{M} 1 = 1 \mathfrak{M} w = w$, and

$$(3.1) \quad a'_i w_1 \mathfrak{M} a'_j w_2 = a'_i (w_1 \mathfrak{M} a'_j w_2) + a'_j (a'_i w_1 \mathfrak{M} w_2) ,$$

for all words $w_1, w_2 \in A'^*$, and all $a'_i, a'_j \in A'$. This is a commutative, associative product with no zero divisors. The algebra $(R\langle A' \rangle, \mathfrak{M})$, will be called the *free shuffle algebra* on the generators a'_1, \dots, a'_k . The coproduct is defined by the map

$$(3.2) \quad \begin{aligned} \Delta : R\langle A' \rangle &\rightarrow R\langle A' \rangle \otimes R\langle A' \rangle \\ \Delta(w) &= \sum_{uv=w} u \otimes v , \end{aligned}$$

and the antipode is given by the map $w \mapsto (-1)^{|w|}w$. The counit $\varepsilon : R\langle A' \rangle \rightarrow R$ is given by projection onto the graded part of weight 0, as previously.

Let $R\langle\langle A \rangle\rangle$ and $R\langle\langle A' \rangle\rangle$ denote the completions of the graded algebras defined above with respect to the augmentation ideals $\ker \varepsilon$. These are just the algebras of formal power series in A, A' respectively. The Hopf algebra structures Δ, Γ , and ε extend in the natural way to the completed algebras, and we shall denote them by the same symbols.

In addition, we introduce k truncation operators $\partial_{a'_i}$ for $1 \leq i \leq k$:

$$(3.3) \quad \begin{aligned} \partial_{a'_i} : R\langle A' \rangle &\rightarrow R\langle A' \rangle \\ \partial_{a'_i}(a'_j w) &= \delta_{ij} w, \end{aligned}$$

for all $a'_j \in A', w \in A'^*$, where δ_{ij} is the Kronecker delta. It is easy to verify that the $\partial_{a'_i}$ are derivations for the shuffle product, and furthermore, that this determines the shuffle product uniquely if we assume that 1 is the unit. The operators $\partial_{a'_i}$ are dual to the operators $w \mapsto a_i w : R\langle A \rangle \rightarrow R\langle A \rangle$ which affix the letter a_i to the left of words $w \in A^*$. That $\partial_{a'_i}$ is a derivation is equivalent to the fact that a_i is primitive for the coproduct Γ by duality.

3.2. Arrangements of hyperplanes and the bar construction. Consider an arrangement of N hyperplanes H_1, \dots, H_N in affine space \mathbb{A}^ℓ . Let k denote a field of characteristic 0 over which the arrangement is defined. For each $1 \leq i \leq N$, choose a linear form $\alpha_i \in k[x_1, \dots, x_\ell]$ such that H_i is the divisor of zeros of α_i . Let

$$\mathcal{O}_M = k[x_1, \dots, x_\ell, \{\alpha_i^{-1}\}_{1 \leq i \leq N}]$$

denote the ring of regular functions on the complement $M = \mathbb{A}_k^\ell \setminus \bigcup_i H_i$. We set

$$d = \sum_{i=1}^{\ell} \frac{\partial}{\partial x_i} dx_i .$$

Consider the de Rham complex of \mathcal{O}_M :

$$(3.4) \quad 0 \longrightarrow \mathcal{O}_M \xrightarrow{d} \Omega^1(\mathcal{O}_M) \xrightarrow{d} \Omega^2(\mathcal{O}_M) \xrightarrow{d} \dots \xrightarrow{d} \Omega^\ell(\mathcal{O}_M) \longrightarrow 0 ,$$

where $\Omega^r(\mathcal{O}_M) = \bigoplus_{1 \leq i_1 < \dots < i_r \leq N} \mathcal{O}_M dx_{i_1} \wedge \dots \wedge dx_{i_r}$ is placed in degree r . Let $H^i(\mathcal{O}_M)$, for $0 \leq i \leq \ell$, denote the corresponding cohomology groups. These are k -vector spaces. Since M is affine, it follows that $H^i(\mathcal{O}_M)$ coincides with the de Rham hypercohomology of M [Gr]. Consider the set of algebraic 1-forms:

$$(3.5) \quad \omega_i = d \log \alpha_i , \quad \text{for } 1 \leq i \leq N .$$

The following theorem is due to Arnold and Brieskorn [O-T, §5.4].

Theorem 3.1. *The cohomology ring $H^*(M)$ is isomorphic to the graded k -algebra A generated by the forms ω_i , for $1 \leq i \leq N$.*

In particular, the cohomology classes of the forms $\omega_1, \dots, \omega_N \in \Omega^1(\mathcal{O}_M)$ are a k -basis for $H^1(\mathcal{O}_M)$. In this section, all tensor products will be taken over the field k unless specified otherwise. Let N denote the kernel of the exterior product

$$N = \ker (\wedge : H^1(\mathcal{O}_M) \otimes H^1(\mathcal{O}_M) \longrightarrow H^2(\mathcal{O}_M)) .$$

We will not require the full strength of theorem 3.1, only the following corollary.

Corollary 3.2. *If a form $\omega \in A$ is a coboundary $d\phi$, then it is zero.*

It follows that N is also the kernel of the map

$$\wedge : \bigoplus_{1 \leq i, j \leq N} k \omega_i \otimes \omega_j \longrightarrow \Omega^2(\mathcal{O}_M) .$$

For each positive integer $m \geq 2$, the vector space $V_m(\mathcal{O}_M)$ of integrable words in the forms ω_i of weight m is defined to be

$$(3.6) \quad V_m(\mathcal{O}_M) = \bigcap_{i+j=m-2} H^1(\mathcal{O}_M)^{\otimes i} \otimes N \otimes H^1(\mathcal{O}_M)^{\otimes j} .$$

This is just the intersection of the kernels of the maps \wedge_i for $1 \leq i \leq m-1$:

$$(3.7) \quad \begin{aligned} \wedge_i : H^1(\mathcal{O}_M)^{\otimes m} &\longrightarrow H^1(\mathcal{O}_M)^{\otimes i-1} \otimes H^2(\mathcal{O}_M) \otimes H^1(\mathcal{O}_M)^{\otimes m-i-1} , \\ \eta_1 \otimes \dots \otimes \eta_m &\mapsto \eta_1 \otimes \dots \otimes (\eta_i \wedge \eta_{i+1}) \otimes \dots \otimes \eta_m . \end{aligned}$$

Its elements can be written as linear combinations of symbols

$$\sum_{I=(i_1, \dots, i_m)} c_I [\omega_{i_1} | \omega_{i_2} | \dots | \omega_{i_m}] ,$$

where $1 \leq i_j \leq N$, and $c_I \in k$, which satisfy the integrability condition:

$$(3.8) \quad \sum_{I=(i_1, \dots, i_m)} c_I \omega_{i_1} \otimes \dots \otimes \omega_{i_{j-1}} \otimes (\omega_{i_j} \wedge \omega_{i_{j+1}}) \otimes \omega_{i_{j+2}} \otimes \dots \otimes \omega_{i_m} = 0 ,$$

for each $1 \leq j \leq m-1$. We set $V_0(\mathcal{O}_M) = k$, and $V_1(\mathcal{O}_M) = H^1(\mathcal{O}_M) = \bigoplus_{i=1}^N k \omega_i$, and define

$$(3.9) \quad V(\mathcal{O}_M) = \bigoplus_{m \geq 0} V_m(\mathcal{O}_M) .$$

The vector space of homotopy-invariant iterated integrals is then defined to be

$$(3.10) \quad B(\mathcal{O}_M) = \mathcal{O}_M \otimes V(\mathcal{O}_M) ,$$

with the obvious grading. This is similar to the zeroth cohomology group of Chen's reduced bar complex on \mathcal{O}_M , which is usually written $H^0(B(\Omega^\bullet \mathcal{O}_M))$, with the difference that it is made up of closed 1-forms only (see [Ch1, Ha1, Ha2, Ko]).

In order to define a differential on $B(\mathcal{O}_M)$, we let

$$\Omega^i B(\mathcal{O}_M) = \Omega^i(\mathcal{O}_M) \otimes_{\mathcal{O}_M} B(\mathcal{O}_M) = \Omega^i(\mathcal{O}_M) \otimes_k V(\mathcal{O}_M) ,$$

and define $d : \Omega^i B(\mathcal{O}_M) \rightarrow \Omega^{i+1} B(\mathcal{O}_M)$ by the formula

$$(3.11) \quad \begin{aligned} d \sum_{I=(i_1, \dots, i_m)} \phi_I \otimes [\omega_{i_1} | \omega_{i_2} | \dots | \omega_{i_m}] &= \sum_{I=(i_1, \dots, i_m)} (-1)^{\deg \phi_I} \phi_I \wedge \omega_{i_1} \otimes [\omega_{i_2} | \dots | \omega_{i_m}] \\ &+ \sum_{I=(i_1, \dots, i_m)} d\phi_I \otimes [\omega_{i_1} | \omega_{i_2} | \dots | \omega_{i_m}] , \end{aligned}$$

where $\phi_I \in \Omega^i(\mathcal{O}_M)$. It follows from the integrability condition (3.8) that $d^2 = 0$. We can therefore consider the following complex

$$(3.12) \quad 0 \longrightarrow B(\mathcal{O}_M) \xrightarrow{d} \Omega^1 B(\mathcal{O}_M) \xrightarrow{d} \Omega^2 B(\mathcal{O}_M) \xrightarrow{d} \dots \xrightarrow{d} \Omega^\ell B(\mathcal{O}_M) \longrightarrow 0 ,$$

where $\Omega^i B(\mathcal{O}_M)$ is placed in degree i . Its cohomology will be denoted $H_{\text{DR}}^i(B(\mathcal{O}_M))$. By definition (3.9), $V(\mathcal{O}_M)$ is contained in the free \mathcal{O}_M shuffle algebra generated by $V_1(\mathcal{O}_M)$, which is a commutative graded Hopf algebra:

$$V(\mathcal{O}_M) \subset k\langle \omega_1, \dots, \omega_N \rangle .$$

The product \mathfrak{m} is the shuffle product defined in (3.1), and the coproduct Δ was defined in (3.2). One can verify that $V(\mathcal{O}_M)$ is preserved by \mathfrak{m} and Δ , and is therefore a graded Hopf subalgebra of $\mathcal{O}_M\langle\omega_1, \dots, \omega_N\rangle$.

Corollary 3.3. *$B(\mathcal{O}_M)$ is a commutative graded algebra for the shuffle product \mathfrak{m} , and has a natural coproduct $\Delta : B(\mathcal{O}_M) \rightarrow B(\mathcal{O}_M) \otimes_{\mathcal{O}_M} B(\mathcal{O}_M)$.*

3.3. Unipotent extensions of differentially simple algebras. Let k be a field of characteristic 0, and let R denote a commutative, unitary k -algebra with ℓ commuting derivations $\partial_1, \dots, \partial_\ell$. Its de Rham complex begins as follows:

$$0 \longrightarrow R \longrightarrow \bigoplus_{1 \leq i \leq \ell} R \longrightarrow \bigoplus_{1 \leq i < j \leq \ell} R \longrightarrow \dots ,$$

where the first map is given by $f \mapsto (\partial_i f)_i$, and the second map sends (f_1, \dots, f_ℓ) to $(\partial_i f_j - \partial_j f_i)_{i < j}$. The ring of constants of R is the k -algebra:

$$H^0(R) = \bigcap_{i=1}^{\ell} \ker \partial_i .$$

Definition 3.4. We say that R is *differentially simple* if $H^0(R) = k$, and if R is a simple module over its ring of differential operators $R[\partial_1, \dots, \partial_\ell]$.

Recall that a differential ideal of R is an ideal $I \subset R$ such that $\partial_i I \subset I$ for all $1 \leq i \leq \ell$. It is immediate that R is differentially simple if and only if it has no differential ideals apart from 0 and R . An equivalent condition is that for every non-zero $r \in R$, there exists an operator $D_r \in R[\partial_1, \dots, \partial_\ell]$ such that $D_r r = 1$. This is the analogue of the notion of a field in differential algebra.

Now let us assume that R is differentially simple. Let B be a differential k -algebra containing R , with differentials we also denote by $\partial_1, \dots, \partial_\ell$.

Definition 3.5. We say that B is *unipotent* if $H^0(B) = k$, and if there exists a filtration by $R[\partial_1, \dots, \partial_\ell]$ -subalgebras $W^i B$ of B :

$$R = W^0 B \subset W^1 B \subset \dots \subset W^{i+1} B \subset \dots \subset B ,$$

such that $B = \bigcup W^i B$, and $W^{i+1} B$ is generated, as an algebra over $W^i B$, by finitely many elements y such that $\partial_1 y, \dots, \partial_\ell y \in W^i B$.

In other words, B is obtained by adding successive primitives to R with respect to the operators $\partial_1, \dots, \partial_\ell$. The following lemma is a variant of a well-known result concerning extensions of differential fields by adjoining primitives.

Lemma 3.6. *Let R be a differentially simple k -algebra, and let $r_1, \dots, r_\ell \in R$ such that $\partial_i r_j = \partial_j r_i$ for all $1 \leq i, j \leq \ell$. On the polynomial ring $R[y]$, we extend the derivations $\partial_1, \dots, \partial_\ell$ by setting*

$$\partial_i y = r_i \in R \quad \text{for } 1 \leq i \leq \ell .$$

The extended operators ∂_i commute and are unique. Suppose that no element $u \in R$ satisfies $\partial_i u = r_i$ (i.e., the class of (r_1, \dots, r_ℓ) is non-zero in $H^1(R)$). Then $R[y]$ is differentially simple.

Proof. Let I be a differential ideal in $R[y]$, and suppose that $f(y) \in I$ is a polynomial in y of minimal degree $n \geq 1$:

$$f(y) = a_n y^n + a_{n-1} y^{n-1} + \dots + a_0 \in I ,$$

where $a_i \in R$, $a_n \neq 0$. Since R is differentially simple, there exists an operator $D \in R[\partial_i]$ such that $D a_n = 1$. After applying this operator to the equation above, we may assume that $a_n = 1$. On applying ∂_i , we obtain

$$(nr_i + \partial_i a_{n-1})y^{n-1} + \dots + (a_1 r_i + \partial_i a_0) \in I .$$

By the minimality of $f(y)$, this polynomial is identically 0, so the set of equations $\partial_i u = r_i$, for $1 \leq i \leq \ell$, already has a solution $u = -a_{n-1}/n \in R$. This contradicts the assumption, and proves that $R[y]$ has no non-trivial differential ideals. \square

Remark 3.7. Since $R[y]$ is differentially simple, it has no non-trivial quotients. For any differential R -algebra $R[\eta]$, where $\partial_i \eta \in R$ for $1 \leq i \leq \ell$, and η satisfies the conditions of the lemma, the element η is therefore transcendental.

Corollary 3.8. *Let B denote a unipotent extension of R , where R is differentially simple. Then B is a polynomial algebra, and every differential R -subalgebra of B is differentially simple.*

Proof. Let A denote a differential R -subalgebra of B . We can formally add primitives y_1, \dots, y_p, \dots to R , where $y_p \in A$, to obtain a sequence of differential algebras

$$R \subset R[y_1] \subset R[y_1, y_2] \subset \dots \subset A = R[y_1, \dots, y_p, \dots] .$$

We can assume that each inclusion is strict, *i.e.*, y_{p+1} is not in $R[y_1, \dots, y_p]$ for each $p \geq 0$. Let

$$\partial_i y_{p+1} = r_{p+1,i} \in R[y_1, \dots, y_p] .$$

Since the ring of constants of B is k , it follows that the primitive y_{p+1} is the unique solution to the equations $\partial_i u = r_{p+1,i}$ for $1 \leq i \leq \ell$ in B , up to some constant in k . Applying the previous lemma inductively, we deduce that $R[y_1, \dots, y_p]$ is differentially simple and pure transcendental for all $p \geq 1$. It follows that A is differentially simple, and that A is a polynomial algebra. \square

Definition 3.9. Let B denote a unipotent extension of a differentially simple k -algebra R . We say that B is a *unipotent closure* of R if

$$H^0(B) = k , \quad \text{and} \quad H^1(B) = 0 .$$

A unipotent closure is closed under the operation of taking 1-primitives: for all $f_1, \dots, f_\ell \in B$ such that $\partial_i f_j = \partial_j f_i$ for all $1 \leq i, j \leq \ell$, there exists a primitive $F \in B$ such that $\partial_1 F = f_1, \dots, \partial_\ell F = f_\ell$.

Definition 3.10. A *pointed differential k -algebra* (R, ε) is a differential k -algebra R and a k -linear homomorphism of algebras $\varepsilon : R \rightarrow k$. Now suppose that R is differentially simple. We define $\mathbf{up}(R, \varepsilon)$ to be the category of unipotent pointed extensions of (R, ε) . Its objects are (B, ε') , where B is a unipotent extension of R , such that the composition $R \rightarrow B \xrightarrow{\varepsilon'} k$ coincides with $\varepsilon : R \rightarrow k$. A morphism ϕ from (B_1, ε_1) to (B_2, ε_2) , is given by a commutative diagram:

$$\begin{array}{ccc} & R & \\ \swarrow & | & \searrow \\ \phi : B_1 & \longrightarrow & B_2 \\ \varepsilon_1 \searrow & \varepsilon \downarrow & \varepsilon_2 \swarrow \\ & k & \end{array}$$

Any object $B \in \mathbf{up}(R, \varepsilon)$ is differentially simple by the previous corollary. It follows that morphisms in $\mathbf{up}(R, \varepsilon)$ are necessarily injective.

Lemma 3.11. *Morphisms in $\mathbf{up}(R, \varepsilon)$ are unique.*

Proof. Consider two morphisms $\phi, \phi' : (B_1, \varepsilon_1) \rightarrow (B_2, \varepsilon_2)$ of pointed unipotent algebras over (R, ε) . If ∂_i , for $1 \leq i \leq \ell$, are the differentials on R , we denote their extensions to B_1 and B_2 by the same symbols. Let $W^\bullet B_1$ denote a filtration on B_1 as in definition 3.5, and suppose by induction that $\phi = \phi'$ on $W^p B_1$. Let $y \in W^{p+1} B$ such that $\partial_i y \in W^p B_1$ for all $1 \leq i \leq \ell$. Then

$$\partial_i(\phi - \phi')(y) = (\phi - \phi')(\partial_i y) = 0, \quad \text{for all } 1 \leq i \leq \ell,$$

and therefore $\phi(y) - \phi'(y) \in H^0(B_2) = k$. Since $\varepsilon_2 \phi(y) = \varepsilon_2 \phi'(y) = \varepsilon_1 y$, it follows that $\phi(y) = \phi'(y)$. Thus $\phi = \phi'$ on $W^{p+1} B$ and the uniqueness follows by induction. \square

Proposition 3.12. *Let $(R, \{\partial_i\}_{1 \leq i \leq \ell}, \varepsilon)$ and $(R', \{\partial'_i\}_{1 \leq i \leq \ell}, \varepsilon')$ denote two differentially simple pointed k -algebras, and let $\phi : (R, \varepsilon) \rightarrow (R', \varepsilon')$ be a non-zero differential homomorphism. Let (U, ε') be a unipotent closure of (R', ε') , and let (B, ε) be any unipotent extension of (R, ε) . Then there is a unique morphism of differential algebras $\phi_* : B \rightarrow U$ which extends ϕ and which is necessarily injective, such that the following diagram commutes:*

$$\begin{array}{ccc} R & \xrightarrow{\phi} & R' \\ \downarrow & & \downarrow \\ B & \xrightarrow{\phi_*} & U \\ \varepsilon \searrow & & \swarrow \varepsilon' \\ & k & \end{array}$$

The map ϕ_* preserves any given filtrations on B and U , i.e., $\phi(W^p B) \subset W^p U$ for all $p \geq 0$. If, furthermore, $H^1(B) = 0$ and ϕ is an isomorphism, then ϕ_* is also an isomorphism.

Proof. Suppose by induction that ϕ_* has been defined on $W^p B$. Since B is unipotent, $W^{p+1} B$ is generated by elements y such that $\partial_i y \in W^p B$. For such y ,

$$\partial'_j \phi_*(\partial_i y) = \phi_*(\partial_j \partial_i y) = \phi_*(\partial_i \partial_j y) = \partial'_i \phi_*(\partial_j y).$$

Since $H^1(U) = 0$, there exists $f \in U$ such that $\partial'_i f = \phi_*(\partial_i y)$ for all $1 \leq i \leq \ell$. We extend the definition of ϕ_* by setting $\phi_*(y) = f + k_y$, where the constant of integration $k_y \in k$ is chosen such that $k_y + \varepsilon'(f) = \varepsilon(y)$. By the previous lemma, y is transcendent, and therefore ϕ_* is well-defined. We obtain a map ϕ_* on the whole of B by induction. The previous corollary implies that B is differentially simple. It follows that ϕ_* is injective because its kernel is a differential ideal in B not equal to B itself. The fact that ϕ_* preserves the filtrations is clear from the construction.

Now suppose that ϕ is an isomorphism and that $H^1(B) = 0$. Applying the same construction to ϕ^{-1} , we obtain a map $(\phi^{-1})_* : U \rightarrow B$. Because of the uniqueness of morphisms in $\mathbf{up}(R, \varepsilon)$, $(\phi^{-1})_*$ is the identity, and therefore ϕ_* is an isomorphism. \square

Corollary 3.13. *A pointed unipotent closure (U, ε) over (R, ε) is a final object in $\mathbf{up}(R, \varepsilon)$, i.e., every unipotent extension $(U, \varepsilon) \rightarrow (B, \varepsilon')$ is an isomorphism.*

We can therefore speak of the unipotent closure U of a pointed differentially simple ring (R, ε) whenever it exists. Since U is a union of polynomial algebras (corollary 3.8), it necessarily has a k -valued point over ε .

Definition 3.14. If U is the unipotent closure of a differentially simple k -algebra R , let $\text{Gal}(U/R)$ be the group of differential automorphisms $\phi : U \rightarrow U$ over R .

It follows from the definitions that $\text{Gal}(U/R)$ is a pro-unipotent group. Now let $\epsilon : R \rightarrow k$ denote a k -valued point on $\text{Spec } R$. The set of k -valued points $\{\phi \in \text{Hom}_k(U, k) : \phi|_R = \epsilon\}$ on $\text{Spec } U$ lying above ϵ , is a principal homogeneous space over $\text{Gal}(U/R)$. There is thus a complete analogy between the theory of unipotent differentially simple extensions and the theory of covering spaces.

3.4. Base points at infinity. We need to repeat the theory of unipotent closures in the case where the base points are at infinity. In order to do this, we need to generalise the notion of a k -valued point for certain differential algebras.

Definition 3.15. Let k be a field. We define

$$(3.13) \quad k\{\epsilon_1, \dots, \epsilon_\ell\} = k[[\epsilon_1, \dots, \epsilon_\ell]] \left[\frac{1}{\epsilon_1}, \dots, \frac{1}{\epsilon_\ell} \right],$$

to be the differential k -algebra of Laurent series in ϵ_i , equipped with ℓ commuting differentials ∂_{ϵ_i} , for $1 \leq i \leq \ell$. Now define the extension

$$(3.14) \quad U\{\epsilon_1, \dots, \epsilon_\ell\} = k\{\epsilon_1, \dots, \epsilon_\ell\}[L_{\epsilon_1}, \dots, L_{\epsilon_\ell}],$$

where L_{ϵ_i} is the formal logarithm of ϵ_i , *i.e.*, $\partial_{\epsilon_i} L_{\epsilon_i} = \epsilon_i^{-1}$ for $1 \leq i \leq \ell$.

The ring of constants of $k\{\epsilon_1, \dots, \epsilon_\ell\}$ is k , and the extension $U\{\epsilon_1, \dots, \epsilon_\ell\}$ is easily verified to be a unipotent closure of $k\{\epsilon_1, \dots, \epsilon_\ell\}$, since $H^0(U\{\epsilon_1, \dots, \epsilon_\ell\}) = k$, and $H^1(U\{\epsilon_1, \dots, \epsilon_\ell\}) = 0$.

Definition 3.16. Let R be a differentially simple k -algebra with ℓ commuting differentials $\partial_1, \dots, \partial_\ell$. We define a $k\{\epsilon_1, \dots, \epsilon_\ell\}$ -point on R to be a k -linear homomorphism

$$p : R \longrightarrow k\{\epsilon_1, \dots, \epsilon_\ell\},$$

which satisfies

$$p \partial_i = \partial_{\epsilon_i} p, \quad \text{for all } 1 \leq i \leq \ell.$$

A $k\{\epsilon_1, \dots, \epsilon_\ell\}$ -point $p : R \rightarrow k\{\epsilon_1, \dots, \epsilon_\ell\}$ defines an ordinary k -valued point if it factorises through $R \rightarrow k[[\epsilon_1, \dots, \epsilon_\ell]]$:

$$\begin{array}{ccc} R & \longrightarrow & k[[\epsilon_1, \dots, \epsilon_\ell]] \xrightarrow{\epsilon_1 = \dots = \epsilon_\ell = 0} k \\ & \searrow & \downarrow \\ & & k\{\epsilon_1, \dots, \epsilon_\ell\} \end{array}$$

At the other extreme, we say that the point p is *at infinity* if $\epsilon_1^{-1}, \dots, \epsilon_\ell^{-1} \in \text{Im } p$.

Example 3.17. Consider the case where $k = \mathbb{Q}$, and $R = \mathbb{Q}[x, 1/x, 1/(1-x)]$ with differential $\partial/\partial x$. This corresponds to the projective line minus three points $\mathbb{P}^1 \setminus \{0, 1, \infty\} = \mathbb{A}^1 \setminus \{0, 1\}$. The set of k -valued points on R is the set $k \setminus \{0, 1\}$. Each $k\{\epsilon\}$ -point

$$p : \mathbb{Q} \left[x, \frac{1}{x}, \frac{1}{1-x} \right] \longrightarrow k\{\epsilon\}$$

satisfies $\partial_\epsilon p(x) = p(\partial_x x) = 1$, and takes x to $\epsilon + c$, where $c \in k$. The set of $k\{\epsilon\}$ -points is therefore the set k . In this case, there are just two points at infinity, given by the maps $p_\lambda : R \rightarrow k\{\epsilon\}$, where $\lambda = 0, 1$; defined as follows:

$$\begin{array}{ccc} x & \mapsto & \epsilon + \lambda \\ \frac{1}{x - \lambda} & \mapsto & \frac{1}{\epsilon} \end{array}.$$

More generally, every corner of the Stasheff polytope $\overline{X}_{S,\delta} \subset \mathfrak{M}_{0,S}^\delta$ defines a base-point at infinity on the ring $\mathcal{O}(\mathfrak{M}_{0,S})$. Given a triangulation $\alpha \in \chi_{S,\delta}^\ell$ of the n -gon (S, δ) , a set of vertex coordinates $x_1^\alpha, \dots, x_\ell^\alpha$ (§2.4) gives rise to a map

$$(\mathcal{O}(\mathfrak{M}_{0,S}), \partial/\partial x_i^\alpha) \longrightarrow k\{\epsilon_1, \dots, \epsilon_\ell\}$$

which sends x_i^α to ϵ_i for $1 \leq i \leq \ell$.

A point at infinity corresponds to a point which is the intersection of a number of normal crossing divisors, and will play the role of a tangential base point.

Definition 3.18. Let R denote any differentially simple k -algebra, with derivations $\partial_1, \dots, \partial_\ell$. We define a *logarithmic Laurent expansion* to be a homomorphism of differential k -algebras:

$$\phi : R \longrightarrow U\{\epsilon_1, \dots, \epsilon_\ell\}$$

There is a natural map $\lambda : U\{\epsilon_1, \dots, \epsilon_\ell\} \longrightarrow k$ which projects on to the constant coefficient in the logarithmic Laurent series. It factorises through

$$U\{\epsilon_1, \dots, \epsilon_\ell\} \longrightarrow k\{\epsilon_1, \dots, \epsilon_\ell\} \longrightarrow k ,$$

where the first map sends L_{ϵ_i} to 0 for $1 \leq i \leq \ell$, and the second map picks out the constant term in the Laurent expansion

$$\sum_{i_1, \dots, i_\ell \geq -N} a_{i_1, \dots, i_\ell} \epsilon_1^{i_1} \dots \epsilon_\ell^{i_\ell} \mapsto a_{0, \dots, 0} .$$

The map λ has a certain number of formal properties, which we will not require explicitly. Given a logarithmic Laurent expansion $\phi : R \rightarrow U\{\epsilon_1, \dots, \epsilon_\ell\}$, we define the *map of constants* of ϕ to be the (k -linear, additive) map

$$\lambda \circ \phi : R \rightarrow k .$$

Lemma 3.19. *Let R be a differentially simple k -algebra, and let $p : R \rightarrow k\{\epsilon_1, \dots, \epsilon_\ell\}$ denote a $k\{\epsilon_1, \dots, \epsilon_\ell\}$ -point. Let B denote a unipotent extension of R . Consider any logarithmic Laurent expansion $\phi : B \rightarrow U\{\epsilon_1, \dots, \epsilon_\ell\}$ over the point p , i.e., such that the following diagram commutes:*

$$\begin{array}{ccc} B & \xrightarrow{\phi} & U\{\epsilon_1, \dots, \epsilon_\ell\} \\ \uparrow & & \uparrow \\ R & \xrightarrow{p} & k\{\epsilon_1, \dots, \epsilon_\ell\} . \end{array}$$

Then ϕ is uniquely determined by its map of constants $\lambda \circ \phi : B \rightarrow k$.

Proof. This follows immediately using the method of proof of proposition 3.12. \square

A map of constants amounts to choosing a constant of integration for each successive primitive in a unipotent extension B of R . We can now copy the results of the previous sections for base points at infinity.

Definition 3.20. Let R denote a differentially simple k -algebra, and let $p : R \rightarrow k\{\epsilon_1, \dots, \epsilon_\ell\}$ be a $k\{\epsilon_1, \dots, \epsilon_\ell\}$ -point. Let $\mathbf{ut}(R, p)$ denote the category of pointed unipotent extensions of (R, p) , whose objects are unipotent R -algebras (B, ϕ) , where $\phi : B \rightarrow U\{\epsilon_1, \dots, \epsilon_\ell\}$ is a logarithmic Laurent expansion (or, equivalently, the corresponding map of constants). Morphisms are defined in a similar manner to the category \mathbf{up} .

The proof of lemma 3.11 and proposition 3.12 go through without any difficulty.

Proposition 3.21. *Morphisms are unique in $\mathbf{ut}(R, p)$, and a unipotent closure U of R is a final object in the category $\mathbf{ut}(R, p)$.*

If U is the unipotent closure of (R, p) , where p is a $k\{\epsilon_1, \dots, \epsilon_\ell\}$ -point, then

$$(3.15) \quad \{\phi : U \rightarrow U\{\epsilon_1, \dots, \epsilon_\ell\}, \phi|_R = p\} .$$

is a principal homogeneous space over $\text{Gal}(U/R)$.

3.5. One-dimensional fibrations and their relative unipotent closures.

Let R denote a differentially simple k -algebra, with commuting differentials $\partial_1, \dots, \partial_\ell$. Suppose that we are given N elements $f_1, \dots, f_N \in R$ which satisfy the condition

$$(3.16) \quad \frac{1}{f_i - f_j} \in R \quad \text{for all } 1 \leq i < j \leq N .$$

Consider the R -algebra

$$(3.17) \quad \widehat{R} = R\left[y, \frac{1}{y - f_1}, \dots, \frac{1}{y - f_N}\right] ,$$

equipped with the derivation ∂_y which is the unique R -linear derivation satisfying $\partial_y y = 1$. Clearly ∂_i, ∂_y commute for all $1 \leq i \leq \ell$. Consider the free shuffle algebra generated by the symbols $\omega_1, \dots, \omega_N$ over \widehat{R} :

$$(3.18) \quad U_{\widehat{R}/R} = \widehat{R} \otimes_k k\langle \omega_1, \dots, \omega_N \rangle ,$$

and let us extend the definition of ∂_y to $U_{\widehat{R}/R}$ by setting

$$(3.19) \quad \partial_y = \partial_y \otimes 1 + \sum_{i=1}^N \frac{1}{y - f_i} \otimes \partial_{\omega_i} ,$$

where the left truncation operators ∂_{ω_i} were defined in §3.1. This makes $U_{\widehat{R}/R}$ into a differential R -algebra. A similar algebra was considered in [Ma], and a specific case is studied in detail in §5. The symbol ω_i represents the formal logarithm $\log(y - f_i)$, for $1 \leq i \leq N$. By analogy with the bar construction, we will write $[\omega_{i_1} | \dots | \omega_{i_m}]$ for the tensor $\omega_{i_1} \otimes \dots \otimes \omega_{i_m}$. The following proposition states that $U_{\widehat{R}/R}$ is a relative unipotent closure over the base R .

Proposition 3.22. $H^0(U_{\widehat{R}/R}) = R$ and $H^1(U_{\widehat{R}/R}) = 0$.

Proof. It is a simple exercise to show that the ring of constants of $U_{\widehat{R}/R}$ is R . The argument is given in the proof of lemma 3.31, and works in complete generality. The fact that $H^1(U_{\widehat{R}/R})$ vanishes is equivalent to the existence of primitives with respect to ∂_y over the base R . The key observation is the following identity, which is valid in $U_{\widehat{R}/R}$, by assumption (3.16):

$$(3.20) \quad \frac{1}{(y - f_i)(y - f_j)} = \frac{1}{f_i - f_j} \left(\frac{1}{y - f_i} - \frac{1}{y - f_j} \right) ,$$

Using this, we can decompose elements of \widehat{R} into partial fractions. It suffices, therefore, to find primitives of expressions of the form

$$\frac{1}{(y - f_i)^n} [\omega_{i_1} | \dots | \omega_{i_m}] ,$$

where $n \in \mathbb{Z}$, and $1 \leq i_1, \dots, i_m \leq N$. If $n = -1$, a primitive is given by

$$[\omega_i | \omega_{i_1} | \dots | \omega_{i_m}]$$

by definition. For other values of n , we can reduce to this case by integrating by parts and using induction. It follows that every element in $U_{\widehat{R}/R}$ has a primitive with respect to ∂_y . \square

Note that there is no integrability condition to be verified because the fibres of the map $\text{Spec } \widehat{R} \rightarrow \text{Spec } R$ are one-dimensional. We now show how to differentiate the symbols $[\omega_{i_1} | \dots | \omega_{i_m}]$ with respect to the operators $\partial_1, \dots, \partial_\ell$ of the base ring R (differentiation under an iterated integral). To do this, consider an R -linear map

$$p : \widehat{R} \longrightarrow R\{\epsilon\} = R[[\epsilon]]\left[\frac{1}{\epsilon}\right]$$

which satisfies $p \partial_y = \partial_\epsilon p$. Then there is a unique logarithmic Laurent expansion:

$$\begin{array}{ccc} U_{\widehat{R}/R} & \xrightarrow{\phi} & R\{\epsilon\}[L_\epsilon] \\ \uparrow & & \uparrow \\ \widehat{R} & \xrightarrow{p} & R\{\epsilon\} \end{array}$$

such that the map of constants is zero on the generators of $U_{\widehat{R}/R}$, *i.e.*,

$$(3.21) \quad \begin{array}{ccc} \lambda \circ \phi : U_{\widehat{R}/R} & \longrightarrow & R \\ [\omega_{i_1} | \dots | \omega_{i_m}] & \mapsto & 0 . \end{array}$$

This follows from the inductive method of proof of proposition 3.12: if $w = [\omega_{i_1} | \dots | \omega_{i_m}]$, and $\phi(\partial_y w) = a$ has already been defined, then $\phi(w)$ is defined to be a primitive of a with respect to ∂_ϵ . The constant of integration is normalised by the condition $\lambda(\phi(w)) = 0$, since the map (3.21) is R -linear.

Proposition 3.23. *The action of the differential operators ∂_i on R , for $1 \leq i \leq \ell$, extend uniquely to $U_{\widehat{R}/R}$ in such a way that the ∂_i commute with each other, and such that:*

$$[\partial_i, \phi] = [\partial_i, \partial_y] = 0 \quad \text{for all } 1 \leq i \leq \ell .$$

For each element $w = [\omega_{i_1} | \dots | \omega_{i_m}] \in W^m U_{\widehat{R}/R}$, $\partial_i w \in W^{m-1} U_{\widehat{R}/R}$. It follows that $U_{\widehat{R}/R}$ is a unipotent differential algebra with respect to all the operators $\partial_1, \dots, \partial_\ell, \partial_y$.

Proof. The map ϕ is injective, since $U_{\widehat{R}/R}$ is differentially simple, and therefore the action of the operators ∂_i on $U_{\widehat{R}/R}$ are induced from $R\{\epsilon\}[L_\epsilon]$ by restriction. More precisely, suppose by induction that the action of the operators ∂_i have already been defined on $W^p U_{\widehat{R}/R}$, for some $p \geq 0$. Let $w \in W^{p+1} U_{\widehat{R}/R}$ such that $\partial_y w \in W^p U_{\widehat{R}/R}$. If we view $U_{\widehat{R}/R}$ as a subalgebra of $R\{\epsilon\}[L_\epsilon]$, then we can write

$$\partial_y \partial_i w = \partial_i \partial_y w \in U_{\widehat{R}/R} .$$

The element $\partial_i w$, which is *a priori* in $R\{\epsilon\}[L_\epsilon]$, in fact lies in $U_{\widehat{R}/R}$. This is because it is a primitive of $\partial_i \partial_y w \in U_{\widehat{R}/R}$, and we know that $H^1(U_{\widehat{R}/R}) = 0$, and $H^0(R\{\epsilon\}[L_\epsilon]) = R$. More explicitly, if $w = [\omega_{i_1} | \dots | \omega_{i_m}]$, then we define

$$\partial_i w = (1 - \lambda \circ \phi) A ,$$

where A is any solution in $U_{\widehat{R}/R}$ to $\partial_y A = \partial_i \partial_y w$. The fact that the operators ∂_i decrease the weight of each such element w is easily proved by induction and is left to the reader. \square

For each $1 \leq i \leq N$, there is a unique R -linear map

$$(3.22) \quad \begin{aligned} p : \widehat{R} &\rightarrow R\{\epsilon\} \\ y - f_i &\mapsto \epsilon, \end{aligned}$$

such that $\partial_\epsilon p = p \partial_y$. It satisfies:

$$p\left(\frac{1}{y - f_j}\right) = \frac{1}{f_i - f_j} \sum_{k \geq 0} \frac{\epsilon^k}{(f_j - f_i)^k} \quad \text{for all } j \neq i.$$

Corollary 3.24. *Suppose that U_R is the unipotent closure of R . Then the algebra $U_R \otimes_R U_{\widehat{R}/R}$ is the unipotent closure of \widehat{R} .*

Proof. By choosing any map p given by equation (3.22) above, we obtain a differential $\widehat{R}[\partial_1, \dots, \partial_\ell, \partial_y]$ -structure on $U_R \otimes_R U_{\widehat{R}/R}$. It is clear that a tensor product of unipotent algebras is unipotent, and that $H^0(U_R \otimes_R U_{\widehat{R}/R}) = k$. Since the operator ∂_y is zero on U_R , it follows that $H^1(U_R \otimes_R U_{\widehat{R}/R}) = 0$. Concretely, in order to find 1-primitives in this algebra, first take a primitive with respect to ∂_y and then adjust the constant of integration in U_R using the fact that $H^1(U_R) = 0$. \square

By iterating the previous corollary, we deduce that any differentially simple algebra R which is of fiber-type (*i.e.*, an iterated sequence of fibrations) has an explicit unipotent closure which is a tensor product of shuffle algebras.

Theorem 3.25. *Let R denote a differentially simple k -algebra, which can be expressed as a finite series of extensions of the type (3.17) satisfying (3.16):*

$$(3.23) \quad k = R_0 \subset R_1 \subset \dots \subset R_n = R,$$

where

$$(3.24) \quad R_t = R_{t-1} \left[y_t, \left(\frac{1}{y_t - f_{t,i}} \right)_{1 \leq i \leq N_t} \right],$$

and $f_{t,i} - f_{t,j}$ is invertible in R_{t-1} for all $1 \leq i < j \leq N_t$, and all $t = 1, \dots, n$. Then the unipotent closure U_R of (R, p) exists, and is isomorphic (as an algebra) to the tensor product of free shuffle algebras on N_t generators, for $1 \leq t \leq n$:

$$(3.25) \quad U_R \cong R \otimes_k \bigotimes_{t=1}^n k\langle \omega_{t,1}, \dots, \omega_{t,N_t} \rangle.$$

Its differential structure is uniquely determined by such a tensor decomposition.

Proof. This follows immediately from the previous corollary by induction. The differential structure is determined by the construction in proposition 3.23. \square

We therefore have an explicit description of the algebraic structure of the unipotent closure of R for any R which is of fiber type. Note that there may be several natural isomorphisms of the form (3.25), even after fixing base-points.

3.6. Iterated integrals. Let \mathcal{O}_M denote the ring of regular functions on an affine hyperplane arrangement as considered in §3.2. \mathcal{O}_M is a differential algebra with ℓ commuting differentials $\partial/\partial x_1, \dots, \partial/\partial x_\ell$. Suppose that $I \subset \mathcal{O}_M$ is any non-zero differential ideal. It must contain a polynomial $P \in k[x_1, \dots, x_\ell]$, since we can multiply by suitable powers of the hyperplane equations α_i to clear denominators. It is clear that there exists a polynomial D_P in the $\partial/\partial x_i$ such that $D_P P = 1$, and therefore $I = \mathcal{O}_M$. It follows that \mathcal{O}_M is differentially simple.

Theorem 3.26. *The de Rham cohomology of $B(\mathcal{O}_M)$ satisfies:*

$$H_{\text{DR}}^0(B(\mathcal{O}_M)) = k, \quad \text{and} \quad H_{\text{DR}}^1(B(\mathcal{O}_M)) = 0,$$

and $B(\mathcal{O}_M)$ is the unipotent closure of \mathcal{O}_M . It follows that every differential \mathcal{O}_M -subalgebra of $B(\mathcal{O}_M)$ is differentially simple, and $B(\mathcal{O}_M)$ is a polynomial algebra.

The proof of this theorem is postponed until §3.7.

Remark 3.27. The theorem in fact holds in much greater generality. Let F denote any differential algebra such that $H^1(F) \cong \bigoplus_{i=1}^N k \omega_i$, where $\omega_i \in \Omega^1(F)$ satisfy

$$\left(\bigoplus_{i,j} k \omega_i \wedge \omega_j \right) \cap d\Omega^1(F) = 0.$$

If k is the field of constants of F , and if $B(F)$ is defined as in §3.2, then it is clear from the proof (§3.7), that $H^0(B(F)) = k$ and $H^1(B(F)) = 0$. Furthermore, when F is differentially simple, every differential F -subalgebra of $B(F)$ is differentially simple, and $B(F)$ is a polynomial algebra.

We now recall the definition of Chen's iterated integrals, which will give an isomorphism of the abstract algebra $B(F)$ with an algebra of multi-valued functions. Let \widehat{M} be a universal covering for M , and let $p : \widehat{M} \rightarrow M$ denote the projection map. Let $b \in M$ denote a base point for M . Given any smooth path $\gamma : [0, 1] \rightarrow M$ beginning at b , and holomorphic 1-forms $\eta_1, \dots, \eta_m \in \Omega^1(M)$, the iterated integral of the word $\eta_m \dots \eta_1$ (note the reversed order of symbols) along γ is defined by

$$\int_{\gamma} \eta_1 \dots \eta_m = \int_{0 < t_1 < \dots < t_m < 1} \gamma^* \eta_1(t_1) \wedge \dots \wedge \gamma^* \eta_m(t_m).$$

One can show using the calculus of variations [Ch1] that the iterated integral of a linear combination of forms $f = \sum_I c_I \omega_{i_1} \dots \omega_{i_m}$ only depends on the homotopy class of γ if and only if the integrability condition (3.8) is satisfied. In this case, an iterated integral varies holomorphically as a function of the endpoint $z = \gamma(1)$ of γ , and therefore defines a holomorphic function on the universal covering \widehat{M} . We can realise $\Omega^*(\mathcal{O}_M)$ as an algebra of differential forms on \widehat{M} by taking the pull-back along the covering map $p : \widehat{M} \rightarrow M$. When we refer to a multi-valued function (or form) on M it will be a linear combination of such iterated integrals with coefficients in \mathcal{O}_M (resp. $\Omega^*(\mathcal{O}_M)$) (compare the multi-valued de Rham complex defined in [H-M]).

Lemma 3.28. ([Ch1, Ha1, Ha2]) *Let $\eta_1, \dots, \eta_l \in \Omega^1(M)$.*

- (1) *Let $1 \leq m \leq l$, and let $\mathfrak{S}(m, l-m)$ denote the set of $(m, l-m)$ -shuffles defined in §2.7. Then the shuffle product formula holds:*

$$\int_{\gamma} \eta_1 \dots \eta_m \int_{\gamma} \eta_{m+1} \dots \eta_l = \sum_{\sigma \in \mathfrak{S}(m, l-m)} \int_{\gamma} \eta_{\sigma(1)} \dots \eta_{\sigma(l)}.$$

- (2) *Let $\gamma_z : [0, 1] \rightarrow M$ denote a smooth family of paths such that $\gamma_z(0) = b$, and $\gamma_z(1) = z \in M$. If $\sum_I c_I \omega_{i_1} \dots \omega_{i_m}$ satisfies the integrability condition (3.8), we have:*

$$\frac{d}{dz} \int_{\gamma_z} \sum_I c_I \omega_{i_m} \dots \omega_{i_1} = \sum_I c_I \omega_{i_1} \int_{\gamma_z} \omega_{i_m} \dots \omega_{i_2}.$$

Definition 3.29. Let $L_b(M)$ denote the \mathcal{O}_M -module generated by all such homotopy-invariant iterated integrals on \widehat{M} . We write $\Omega^i(L_b(M)) = L_b(M) \otimes_{\mathcal{O}_M} \Omega^i(\mathcal{O}_M)$.

By the previous lemma, $\Omega^*(L_b(M))$ is a differential algebra, and there is a map:

$$(3.26) \quad \begin{aligned} \rho_b : \Omega^* B(\mathcal{O}_M) &\xrightarrow{\sim} \Omega^* L_b(\widehat{M}) \\ \sum_I \phi_I[\omega_{i_1} | \dots | \omega_{i_m}] &\mapsto \sum_I \phi_I \int_{\gamma} \omega_{i_m} \dots \omega_{i_1} , \end{aligned}$$

which is a surjective map of differential algebras by (3.11). As above, γ denotes a smooth path beginning at the point $b \in M$. The kernel of ρ_b is a differential ideal, and therefore must reduce to zero since $B(\mathcal{O}_M)$ is differentially simple. Therefore (3.26) is an isomorphism.

Corollary 3.30. *If $\{e_i\}$ is a basis for $B(\mathcal{O}_M)$ over \mathcal{O}_M , then the functions $\rho_b(e_i)$ are linearly independent over \mathcal{O}_M . All algebraic relations between the functions $\rho_b(e_i)$ are determined by the shuffle product.*

One can determine a basis for $B(\mathcal{O}_M)$ in the fiber-type case (see §6.2).

3.7. Proof of theorem 3.26. We first show that the ring of constants of $B(\mathcal{O}_M)$ is k . For any $\psi \in B(\mathcal{O}_M)$, $n \geq 0$, we write $\psi_n = \text{gr}_n^w \psi$ for its graded part of weight n .

Lemma 3.31. $H_{\text{DR}}^0(B(\mathcal{O}_M)) = k$.

Proof. Let $\psi \in B(\mathcal{O}_M)$ of weight $m \geq 1$ such that $d\psi = 0$. We write

$$\psi_r = \sum_{I=(i_1, \dots, i_r)} f_I[\omega_{i_1} | \dots | \omega_{i_r}] \quad \text{for } 0 \leq r \leq m ,$$

where each $f_I \in \mathcal{O}_M$. Then the graded weight m part of $d\psi$ is zero:

$$(d\psi)_m = \sum_{|I|=m} df_I[\omega_{i_1} | \dots | \omega_{i_m}] = 0 .$$

Therefore $df_I = 0$ and so $f_I \in H_{\text{DR}}^0(\mathcal{O}_M) = k$ for all ordered sets I such that $|I| = m$. The weight $m-1$ part of $d\psi$ is also zero:

$$(d\psi)_{m-1} = \sum_{|I|=m} f_I \omega_{i_1}[\omega_{i_2} | \dots | \omega_{i_r}] + \sum_{J=(i_2, \dots, i_m)} df_J[\omega_{i_2} | \dots | \omega_{i_m}] = 0 ,$$

which implies that

$$f_{i_1, i_2, \dots, i_m} \omega_{i_1} + df_{i_2, \dots, i_m} = 0 \quad \text{for all } i_2, \dots, i_m .$$

Therefore the forms $f_{i_1, \dots, i_m} \omega_{i_1}$ are exact for all i_1, \dots, i_m . But since we have shown that $f_{i_1, \dots, i_m} \in k$ is constant, this can only occur if $f_{i_1, \dots, i_m} = 0$. This implies that the weight of ψ is at most $m-1$, which contradicts the initial assumption. Therefore, any ψ such that $d\psi = 0$ is of weight 0, and lies in \mathcal{O}_M . Hence $\psi \in H_{\text{DR}}^0(\mathcal{O}_M) = k$. \square

The following lemma states that we can replace a closed 1-form in $B(\mathcal{O}_M)$ with an element in its cohomology class of strictly lower weight.

Lemma 3.32. *Let $\psi \in \Omega^1(B(\mathcal{O}_M))$ be an element of weight m such that $d\psi = 0$. Then there exists $\theta \in B(\mathcal{O}_M)$ such that $\kappa = \psi - d\theta$ is of weight at most $m-1$.*

Proof. Let

$$\psi = \sum_{r=0}^m \sum_{I=(i_1, \dots, i_r)} \phi_I [\omega_{i_1} | \dots | \omega_{i_r}] ,$$

where $\phi_I \in \Omega^1 \mathcal{O}_M$ for all indexing sets I . Since $d\psi = 0$, we deduce that

$$0 = \sum_{|I|=m} d\phi_I [\omega_{i_1} | \dots | \omega_{i_m}] - \sum_{|I|=m} \phi_I \wedge \omega_{i_1} [\omega_{i_2} | \dots | \omega_{i_m}] + \sum_{r=0}^{m-1} d(\psi_r) .$$

This implies firstly that $d\phi_I = 0$ for all sets I with $|I| = m$, and secondly that

$$(3.27) \quad \sum_{r=0}^{m-1} d(\psi_r) - \sum_{I=(i_1, \dots, i_m)} \phi_I \wedge \omega_{i_1} [\omega_{i_2} | \dots | \omega_{i_m}] = 0 .$$

Taking the graded part of this equation of weight $m-1$, we deduce that

$$- \sum_{I=(i_1, \dots, i_m)} \phi_I \wedge \omega_{i_1} [\omega_{i_2} | \dots | \omega_{i_m}] + \sum_{i_2, \dots, i_m} d\phi_{i_2, \dots, i_m} [\omega_{i_2} | \dots | \omega_{i_m}] = 0 ,$$

and so

$$(3.28) \quad \sum_{i_1} \phi_{i_1, \dots, i_m} \wedge \omega_{i_1} = d\phi_{i_2, \dots, i_m} ,$$

for all $I = (i_1, \dots, i_m)$. We have shown that ϕ_I is closed for $|I| = m$, so we can write

$$(3.29) \quad \phi_I = \sum_j \alpha_{I,j} \omega_j + dg_I .$$

where $\alpha_{I,j} \in k$, and $g_I \in \mathcal{O}_M$. Substituting into (3.28) above, we have

$$\sum_{i_1, j} \alpha_{i_1, \dots, i_m, j} \omega_j \wedge \omega_{i_1} + \sum_{i_1} dg_{i_1, \dots, i_m} \wedge \omega_{i_1} = d\phi_{i_2, \dots, i_m} ,$$

for all i_2, \dots, i_m . The corollary to theorem 3.1 implies that any linear combination of exterior products of forms ω_i which is exact, is necessarily zero. Using the fact that $dg_{i_1, \dots, i_m} \wedge \omega_{i_1} = d(g_{i_1, \dots, i_m} \wedge \omega_{i_1})$ is exact, we have

$$(3.30) \quad \sum_{i_1, j} \alpha_{i_1, \dots, i_m, j} \omega_j \wedge \omega_{i_1} = 0 , \quad \text{for all } i_2, \dots, i_m .$$

Let

$$\theta_1 = \sum_{I=(i_1, \dots, i_m)} \sum_j \alpha_{I,j} [\omega_j | \omega_{i_1} | \dots | \omega_{i_m}] .$$

Since the integrability condition (3.8) is homogeneous with respect to the weight, the integrability of ψ implies the integrability of $\psi_m = \sum_{|I|=m} \phi_I [\omega_{i_1} | \dots | \omega_{i_m}]$. This is equivalent to a number of linear equations of the form $\sum_{|I|=m} \lambda_I \phi_I = 0$, where $\lambda_I \in k$. Using the decomposition (3.29), and the fact that $\text{Im}(\bigoplus_{i < j} k \omega_i \wedge \omega_j \rightarrow \Omega^1(\mathcal{O}_M))$ and $d\mathcal{O}_M$ are complementary spaces (this follows from theorem (3.1)), we deduce that

$$(3.31) \quad \sum_{I=(i_1, \dots, i_m)} \sum_j \alpha_{I,j} \omega_j [\omega_{i_1} | \dots | \omega_{i_m}] .$$

is integrable, as is $\sum_{|I|=m} dg_I[\omega_{i_1}|\dots|\omega_{i_m}]$. By adding constants, we can assume that the primitives g_I of dg_I satisfy the same linear equations $\sum_{|I|=m} \lambda_I g_I = 0$. This ensures that

$$\theta_2 = \sum_{|I|=m} g_I[\omega_{i_1}|\dots|\omega_{i_m}]$$

satisfies the integrability criterion also. The integrability of θ_1 follows from (3.31) and (3.30). We set $\theta = \theta_1 + \theta_2 \in B(\mathcal{O}_M)$. By construction, we have

$$\begin{aligned} d\theta - \psi &= d\left(\sum_{I=(i_1,\dots,i_m)} \sum_j \alpha_{I,j} [\omega_j|\omega_{i_1}|\dots|\omega_{i_m}] + g_I[\omega_{i_1}|\dots|\omega_{i_m}]\right) - \psi \\ &= \sum_{|I|=m} \left(\sum_j \alpha_{I,j} \omega_j + dg_I\right) [\omega_{i_1}|\dots|\omega_{i_m}] + g_I \wedge \omega_{i_1}[\omega_{i_2}|\dots|\omega_{i_m}] - \psi, \\ &= \sum_{|I|=m} g_I \wedge \omega_{i_1}[\omega_{i_2}|\dots|\omega_{i_m}] - (\psi_0 + \dots + \psi_{m-1}), \end{aligned}$$

which is of weight at most $m-1$, since all terms of weight m cancel by (3.29). \square

Given a closed form $\psi \in \Omega^1(\mathcal{O}_M)$ of weight m , we defined an explicit $\theta \in B(\mathcal{O}_M)$ such that $\psi = d\theta + \psi_1$, and ψ_1 is of weight $\leq m-1$. In fact, θ is of weight at most $m+1$. Applying the lemma repeatedly, we obtain a series of forms $\psi_1, \dots, \psi_m \in \Omega^1(\mathcal{O}_M)$ and $\theta_1, \dots, \theta_m \in B(\mathcal{O}_M)$, where ψ_i is of weight at most $m-i$, such that

$$\psi_i = d\theta_i + \psi_{i+1}.$$

At the final stage, $\psi_m = d\theta_m$. Thus $\psi = d(\theta + \theta_1 + \dots + \theta_m)$, and $\theta + \theta_1 + \dots + \theta_m$ is a primitive of ψ of weight at most $m+1$.

As remarked earlier, the argument in the proof of the lemma can be both generalised and simplified using spectral sequence arguments (see the appendix).

Corollary 3.33. $H_{\text{DR}}^1(B(\mathcal{O}_M)) = 0$.

This completes the proof of theorem 3.26. The fact that every \mathcal{O}_M -subalgebra of $B(\mathcal{O}_M)$ is differentially simple, and the fact that $B(\mathcal{O}_M)$ is a polynomial algebra, follows from the results of §3.3.

3.8. Fibrations of hyperplane arrangements. We recall necessary and sufficient conditions for an affine hyperplane arrangement to decompose as a fibration over an arrangement of smaller dimension [O-T]. We deduce from the results of §3.5 that the reduced bar construction has trivial cohomology for fiber-type arrangements.

Let $\mathfrak{H} = \{H_1, \dots, H_N\}$ denote any affine hyperplane arrangement in \mathbb{A}^ℓ . Choose any affine subspace $W \cong \mathbb{A}^e$ contained in \mathbb{A}^ℓ and let $V_0 \subset \mathbb{A}^\ell$ denote a complementary subspace such that

$$\mathbb{A}^\ell \cong V_0 \oplus W.$$

For each $z \in \mathbb{A}^e \cong W$, let $V_z = V_0 + z$ denote the affine space parallel to V passing through the point $z \in W$. The spaces V_z define a vertical direction normal to the base W . We define the set of vertical hyperplanes to be

$$\mathfrak{H}^v = \{H \in \mathfrak{H} : H \text{ contains } V_z \text{ for some } z \in W\},$$

and let \mathfrak{H}^h denote the set of all remaining hyperplanes. There is a decomposition

$$\mathfrak{H} = \mathfrak{H}^v \sqcup \mathfrak{H}^h,$$

and it is clear that every horizontal hyperplane $H \in \mathfrak{H}^h$ intersects each V_z properly. Consider the complements

$$M = \mathbb{A}^\ell \setminus \bigcup_{H \in \mathfrak{H}} H, \quad \text{and} \quad M' = W \setminus \bigcup_{H \in \mathfrak{H}^v} H \cap W.$$

The linear projection $\mathbb{A}^\ell \rightarrow W$ with kernel V_0 induces a surjective map $p : M \rightarrow M'$.

Lemma 3.34. *The map p is a fibration if and only if the following condition holds: for all $H, H' \in \mathfrak{H}$ such that $H \cap H' \neq \emptyset$, there exists $H'' \in \mathfrak{H}^v$ such that*

$$H'' \supseteq H \cap H'.$$

The fibre over $z \in M'$ is the complement $V_z \setminus \bigcup_{H \in \mathfrak{H}^h} (H \cap V_z)$.

The proof is left as an exercise.

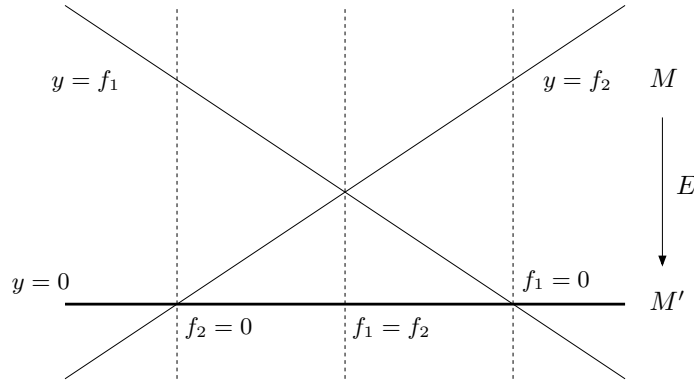

FIGURE 12. An arrangement M in \mathbb{A}^ℓ which fibers over $M' \subset \mathbb{A}^{\ell-1}$ (the thick line at the bottom). A vertical hyperplane (dashed) passes through every point where horizontal hyperplanes intersect.

Definition 3.35. An affine hyperplane arrangement is said to be of *fiber-type* if it can be expressed as an iterated sequence of linear fibrations whose fibers are of dimension 1. Thus there is a sequence of fibrations

$$(3.32) \quad M \xrightarrow{E_1} M_1, \quad \dots, \quad M_{\ell-2} \xrightarrow{E_{\ell-1}} M_{\ell-1},$$

where $E_1, \dots, E_{\ell-1}$, and $E_\ell = M_{\ell-1}$, are of dimension 1.

We consider in greater detail the case where the dimension of the fibres is 1. Then each fibre is isomorphic to \mathbb{A}^1 minus a finite number of points. Let us choose coordinates compatible with the direct sum decomposition $\mathbb{A}^\ell = W \oplus V_0$. In other words, let $x_1, \dots, x_{\ell-1}$ denote coordinates on $\mathbb{A}^{\ell-1} = W$, and let y denote the vertical coordinate on $\mathbb{A}^1 = V_0$. Let \mathcal{O}_M and $\mathcal{O}_{M'}$ denote the rings of regular functions on the affine schemes M and M' respectively. Let us write the equations of all horizontal hyperplanes in the form $y - f_i = 0$, where $f_i \in \mathcal{O}_{M'}$, and $1 \leq i \leq N_h$, for some integer N_h . Thus $H_i = \ker(y - f_i)$ for $1 \leq i \leq N_h$. By the previous lemma, the fact that M is a fibration is equivalent to the equations (see figure 12):

$$(3.33) \quad \frac{1}{f_i - f_j} \in \mathcal{O}_{M'} \quad \text{for all } 1 \leq i, j \leq N_h.$$

We have

$$(3.34) \quad \mathcal{O}_M = \mathcal{O}_{M'} \left[y, \frac{1}{y-f_1}, \dots, \frac{1}{y-f_{N_h}} \right].$$

We have already shown that the rings \mathcal{O}_M and $\mathcal{O}_{M'}$ are differentially simple over k . We are therefore in the situation considered in §3.5 (compare (3.16) and (3.17)).

Definition 3.36. Let us write $\beta_i = dy/(y-f_i)$ for $1 \leq i \leq N_h$. We define the *relative bar construction* of M over the base M' to be the free \mathcal{O}_M -shuffle algebra:

$$(3.35) \quad B_{M'}(E) = \mathcal{O}_M \langle \beta_1, \dots, \beta_{N_h} \rangle.$$

The relative bar construction is a differential \mathcal{O}_M -algebra with respect to the operator $\partial/\partial y$. Note that since E is of dimension 1, there is no integrability condition. Proposition 3.22 gives:

$$(3.36) \quad H^0(B_{M'}(E)) = \mathcal{O}_{M'}, \text{ and } H^1(B_{M'}(E)) = 0.$$

Proposition 3.23 and its corollary imply the following result.

Corollary 3.37. *For each $\mathcal{O}_{M'}$ -linear map $p : \mathcal{O}_M \rightarrow \mathcal{O}_{M'}[[\epsilon]][1/\epsilon]$ which satisfies $p\partial_y = \partial_\epsilon p$, there is a natural action of the operators $\partial/\partial x_1, \dots, \partial/\partial x_{\ell-1}$ on $B_{M'}(E)$, such that the $\partial/\partial x_i$ commute with p . As a result, $B(M') \otimes_{\mathcal{O}_{M'}} B_{M'}(E)$ is the unipotent closure of \mathcal{O}_M . We deduce that there is an isomorphism of differential $\mathcal{O}_M[\partial/\partial x_1, \dots, \partial/\partial x_{\ell-1}, \partial/\partial y]$ algebras:*

$$B(M) \cong B(M') \otimes_{\mathcal{O}_{M'}} B_{M'}(E).$$

The following theorem follows by induction.

Theorem 3.38. *Let M be a fiber-type affine hyperplane arrangement with fibrations (3.32). There is a (non-unique) isomorphism of differential algebras*

$$B(M) \cong B_{M_1}(E_1) \otimes_{\mathcal{O}_{M_1}} \dots \otimes_{\mathcal{O}_{M_{\ell-1}}} B_{M_{\ell-1}}(E_{\ell-1}) \otimes_{\mathcal{O}_{M_{\ell-1}}} B(E_\ell).$$

Corollary 3.39. *The de Rham cohomology of the reduced bar construction on a fiber-type affine hyperplane arrangement defined over a field k is trivial:*

$$H_{\text{DR}}^0(B(M)) \cong k \quad \text{and} \quad H_{\text{DR}}^i(B(M)) = 0 \quad \text{for all } i \geq 1.$$

The reason why this result is true is essentially because arrangements of fiber type are rational $K(\pi, 1)$ spaces (see [F-R], [H-M]). By (2.3), $\mathfrak{M}_{0,S}$ is a fiber-type affine hyperplane arrangement over \mathbb{Q} .

Corollary 3.40. *In the case of moduli spaces $\mathfrak{M}_{0,S}$ this gives:*

$$H_{\text{DR}}^0(B(\mathfrak{M}_{0,S})) = \mathbb{Q}, \quad \text{and} \quad H_{\text{DR}}^i(B(\mathfrak{M}_{0,S})) = 0 \quad \text{for all } i \geq 1.$$

The primitive of a closed form $f \in W^b \Omega^i B(\mathfrak{M}_{0,S})$ is of weight at most $b+1$.

This result can be proved directly using the fact that the hyperplane arrangement $\mathfrak{M}_{0,S}$ is quadratic (see appendix 1). This is equivalent to corollary 8.7 in [H-M], since $\mathfrak{M}_{0,p+2} = Y_1^p$ in the notation of that paper. The fact that primitives increase the weight by at most one is clear from the definition of the differential (3.11) on $B(\mathcal{O}_M)$.

In the case of the moduli spaces $\mathfrak{M}_{0,S}$, we can make the decomposition of theorem 3.38 totally canonical by working in cubical coordinates (2.5). The corresponding fibrations are given by the maps $(x_1, \dots, x_\ell) \mapsto (x_1, \dots, x_{\ell-1})$ (§2.3). Furthermore,

there is a base-point at infinity corresponding to the origin, which is compatible with this sequence of fibrations. It is given by the map:

$$\mathcal{O}(\mathfrak{M}_{0,S}) \cong \mathbb{Q} \left[(x_i^{\pm 1})_{1 \leq i \leq \ell}, \left(\frac{1}{1 - x_i \dots x_j} \right)_{1 \leq i \leq j \leq \ell} \right] \longrightarrow k\{\epsilon_1, \dots, \epsilon_\ell\}$$

$$x_i \mapsto \epsilon_i .$$

There is a corresponding logarithmic Laurent expansion over this point, whose map of constants is trivial:

$$(3.37) \quad B(\mathfrak{M}_{0,S}) \longrightarrow U\{\epsilon_1, \dots, \epsilon_\ell\}$$

$$\sum_{I=(i_1, \dots, i_m)} c_I[\omega_{i_1} | \dots | \omega_{i_m}] \mapsto 0 .$$

Because we have fixed a $k\{\epsilon_1, \dots, \epsilon_\ell\}$ -point, the isomorphism in theorem 3.38 is unique.

Corollary 3.41. *In cubical coordinates, there is a canonical isomorphism*

$$B(\mathfrak{M}_{0,S}) \cong \mathcal{O}(\mathfrak{M}_{0,S}) \otimes_{\mathbb{Q}} \bigotimes_{k=1}^{\ell} \mathbb{Q}\langle [d \log x_k], [d \log(1 - x_i \dots x_k)]_{1 \leq i \leq k} \rangle ,$$

where the algebras on the right are free shuffle algebras.

There is a similar decomposition for any set of vertex coordinates $x_1^\alpha, \dots, x_\ell^\alpha$, where $\alpha \in \chi_{S,\delta}^\ell$ does not contain an internal triangle.

Remark 3.42. In order to compute the periods of $\mathfrak{M}_{0,S}$, we shall only require the fact that $H^\ell(B(\mathfrak{M}_{0,S})) = 0$, where $\ell = |S| - 3$. In cubical coordinates, this is equivalent to finding a primitive to

$$f dx_1 \dots dx_\ell \quad \text{for all } f \in B(\mathfrak{M}_{0,S}) .$$

We have in fact proved a much stronger result. Corollary 3.41 implies that we can find $F \in B(\mathfrak{M}_{0,S})$ such that $\partial F / \partial x_\ell = f$. The constant term of F is uniquely determined by the map of constants (3.37). In other words, there is a primitive of the form

$$F dx_1 \dots dx_{\ell-1} ,$$

where the weight of F is at most one more than the weight of f . The primitive F constructed in this way has the advantage that is unique.

Example 3.43. Consider the fibration $\mathfrak{M}_{0,5} \rightarrow \mathfrak{M}_{0,4}$, whose fibres are isomorphic to \mathbb{A}^1 minus 3 points (fig. 13). In cubical coordinates, we have:

$$\mathcal{O}_{M'} \cong \mathbb{Q} \left[x, \frac{1}{x}, \frac{1}{1-x} \right] ,$$

$$\mathcal{O}_M \cong \mathcal{O}_{M'} \left[y, \frac{1}{y}, \frac{1}{1-y}, \frac{x}{1-xy} \right] ,$$

where the fibration map is the projection onto the x -axis:

$$(x, y) \mapsto x : \mathfrak{M}_{0,5} \rightarrow \mathbb{P}^1 \setminus \{0, 1, \infty\} .$$

There is a natural $k\{\epsilon_1, \epsilon_2\}$ -point at the origin which sends

$$(3.38) \quad p : \mathcal{O}_M \longrightarrow k\{\epsilon_1, \epsilon_2\}$$

$$x \mapsto \epsilon_1$$

$$y \mapsto \epsilon_2 ,$$

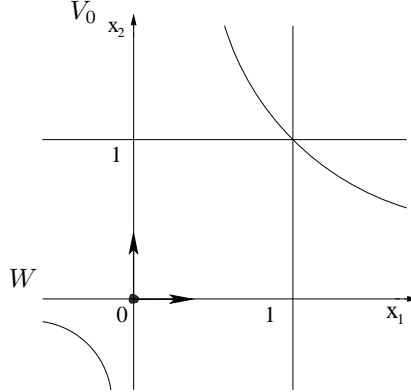

FIGURE 13. In cubical coordinates, there is a natural base point at infinity on $\mathfrak{M}_{0,5}$ corresponding to $(0, 0)$.

and which maps, for example, $x/(1-xy)$ to $\sum_{i \geq 0} \epsilon_1^{i+1} \epsilon_2^i$. The differential algebra $B(M') = B(\mathbb{P}^1 \setminus \{0, 1, \infty\})$ is the universal algebra of multiple polylogarithms in one variable defined in [Br1], and $B_{M'}(E)$ is the relative bar construction over $\mathcal{O}_{M'}$. As algebras, each one is the free non-commutative algebra on two (respectively three) symbols:

$$B(M') = \mathcal{O}_{M'} \left\langle \frac{dx}{x}, \frac{dx}{1-x} \right\rangle, \quad \text{and} \quad B_{M'}(E) = \mathcal{O}_M \left\langle \frac{dy}{y}, \frac{dy}{1-y}, \frac{xdy}{1-xy} \right\rangle.$$

Corollary 3.41 gives a canonical isomorphism

$$B(M') \otimes_{\mathcal{O}_{M'}} B_{M'}(E) \xrightarrow{\sim} B(M),$$

and enables us to write down a basis of integrable words in $B(M)$. However, the map $B_{M'}(E) \rightarrow B(M)$ is far from trivial. For example, it gives

$$1 \otimes \left[\frac{dy}{1-y} \middle| \frac{xdy}{1-xy} \right] \mapsto \left[\frac{dy}{1-y} - \frac{dx}{1-x} - \frac{dx}{x} \middle| \frac{xdy + ydx}{1-xy} \right] + \left[\frac{dx}{1-x} \middle| \frac{dy}{1-y} \right].$$

A similar formula was given in [Zh] and [Ha3]. It is obvious that the left-hand side is integrable, the right hand side not so. The left-hand coding can be retrieved from the one on the right by formally setting $dx = 0$. The map $B_{M'}(E) \rightarrow B(M)$ is canonically normalised in such a way that, apart from all terms of the form $[\frac{dy}{y}] \amalg \dots \amalg [\frac{dy}{y}]$, its image vanishes on setting $dy = y = 0$. The logarithmic Laurent expansion of this example is given by the multiple logarithm (see §5.4):

$$\text{Li}_{1,1}(x, y) = \sum_{0 < k < l} \frac{x^k y^l}{kl},$$

where we have written x, y instead of ϵ_1, ϵ_2 . The coding on the left-hand side of the equation above only takes into account the differential equations which $\text{Li}_{1,1}(x, y)$ satisfies with respect to the variable y (which are very simple), the right-hand side encodes the differential equations with respect to both variables x and y . The coproduct of $\text{Li}_{1,1}(x, y)$ can be read off the right-hand coding directly:

$$\begin{aligned} \Delta \text{Li}_{1,1}(x, y) &= \text{Li}_{1,1}(x, y) \otimes 1 + (\log(1-y) - \log(1-x) + \log x) \otimes \log(1-xy) \\ &\quad + \log(1-x) \otimes \log(1-y) + 1 \otimes \text{Li}_{1,1}(x, y). \end{aligned}$$

One can compare this with the coproduct for the motivic multiple polylogarithms defined by Goncharov [Go1].

We therefore have two different points of view on $B(\mathfrak{M}_{0,S})$. On the one hand, there is a direct definition in terms of hyperplane configurations, from which the differential structure and the action of the symmetric group are evident. The problem is that the complexity of the set of integrable words grows rapidly, and the algebraic structure is obscured. On the other hand, using the fibration map above, we have a description of $B(\mathfrak{M}_{0,S})$ as a product of free shuffle algebras, from which its algebraic structure is completely evident. But this point of view breaks the symmetry and only part of the differential structure is visible. By exploiting both points of view, one can deduce a lot of information about the structure of $B(\mathfrak{M}_{0,S})$. In particular, by regarding it as a representation of the symmetric group, one obtains many interesting functional relations between multiple polylogarithms.

4. MANIFOLDS WITH CORNERS AND FUCHSIAN DIFFERENTIAL EQUATIONS

Let X denote a real analytic manifold with corners. We consider functions on X which have logarithmic singularities along the boundary of X , and we define the regularised limit of such a function along components of the boundary ∂X . Next, we state and prove a generalised Fuchs theorem in many variables, and show that, in the unipotent case, we obtain solutions on X which are precisely of this type, *i.e.*, which have logarithmic singularities along ∂X . Finally, we state a version of Stokes' theorem in the case when X is compact. This requires some regularity results which allow the integration of functions with logarithmic divergences along the boundary of X . The example to bear in mind throughout this section is when $X = \overline{X}_{S,\delta}$ is the closed Stasheff polytope defined in §2.5.

4.1. Manifolds with corners. A manifold with corners X is a differentiable manifold whose charts are diffeomorphic to sets of the form

$$U_{p,q} = \mathbb{R}^p \times \mathbb{R}_+^q ,$$

where $\mathbb{R}_+ = \{x \in \mathbb{R} : x \geq 0\}$, and $p, q \geq 0$ [B-S]. If $q \geq 1$, the boundary of $U_{p,q}$ is

$$(4.1) \quad \partial U_{p,q} = \bigcup_{i+j=q-1} \mathbb{R}^p \times \mathbb{R}_+^i \times \{0\} \times \mathbb{R}_+^j ,$$

which is a union of sets diffeomorphic to $U_{p,q-1}$, and is empty if $q = 0$. Let $\partial^i U_{p,q}$ denote the successive submanifolds with corners obtained by iteration. There is a stratification

$$U_{p,q} \supseteq \partial U_{p,q} \supseteq \dots \supseteq \partial^q U_{p,q} ,$$

which has the combinatorial structure of a face of a hypercube. There are many different ways to define maps between charts depending on how rigid we wish to make the manifold X . We require that derivatives of maps between charts do not vanish along boundary components, and in order for logarithmic regularisation to be well-defined, we must rule out maps of the form $x \mapsto kx : \mathbb{R}_+ \rightarrow \mathbb{R}_+$, where $k \neq 1$.

Definition 4.1. Let $n = p + q \geq 1$, and let x_1, \dots, x_n be coordinates on \mathbb{R}^n such that $U_{p,q} = \mathbb{R}^p \times \mathbb{R}_+^q = \{x_1 \geq 0, \dots, x_q \geq 0\}$. Let \mathfrak{S}_q denote the symmetric group on q letters which permutes the indices $1, \dots, q$. We define $\text{Hom}_{\text{an}}(U_{p,q}, U_{p,q})$ to be the ring of analytic isomorphisms (*i.e.*, whose Jacobian does not vanish anywhere along $U_{p,q}$):

$$\phi = (\phi_1, \dots, \phi_n) : U_{p,q} \longrightarrow U_{p,q}$$

which permute the components of the boundary $\partial U_{p,q}$, *i.e.*,

$$\phi_i \Big|_{x_{\sigma(i)}=0} = 0 , \quad \text{for } 1 \leq i \leq q ,$$

where $\sigma \in \mathfrak{S}_q$, and which satisfy

$$\frac{\partial \phi_i}{\partial x_{\sigma(i)}} \Big|_{x_{\sigma(i)}=0} = 1 .$$

In other words, $\phi = (x_{\sigma(1)} f_1, \dots, x_{\sigma(q)} f_q, \phi_{q+1}, \dots, \phi_n)$, where f_i are analytic functions such that f_i is identically equal to 1 along the boundary component $\{x_{\sigma(i)} = 0\} \subset \partial U_{p,q}$, for $1 \leq i \leq q$. For example, if $n = 2$ and $U_{0,2} = \{(x_1, x_2) : x_1, x_2 \geq 0\}$, the map $\phi(x_1, x_2) = (x_1 + x_1^2 x_2, x_2 + x_2^2)$ is in $\text{Hom}_{\text{an}}(U_{0,2}, U_{0,2})$.

We define an *analytic manifold with corners* to be a manifold with corners, all of whose transition maps lie in $\text{Hom}_{\text{an}}(U_{p,q}, U_{p,q})$.

It follows from this definition that any $\phi \in \text{Hom}_{\text{an}}(U_{p,q}, U_{p,q})$ preserves the boundary stratification of $U_{p,q}$ (4.1). Any analytic manifold with corners therefore admits a global stratification

$$X = X_0 \supseteq X_1 \supseteq X_2 \supseteq \dots \supseteq X_n ,$$

where each X_i is a manifold with corners, and $X_{i+1} = \partial X_i$ is the union of the boundary components of X_i .

Consider the closed Stasheff polytope $X = \overline{X}_{S,\delta}$ contained in $\mathfrak{M}_{0,S}^\delta(\mathbb{R})$. Then X is a manifold with corners whose stratification is given by (2.36). To see this, let $0 < \varepsilon \ll 1$ denote a small constant, and let $e \in \chi_{S,\delta}^k$ denote a k -decomposition of the regular n -gon (S, δ) . This can be completed, in a non-unique way, to a full triangulation $\alpha \in \chi_{S,\delta}^\ell$. Then F_α is a corner contained in the face $F_e = \{u_{ij} = 0 : \{i, j\} \in e\}$. Define

$$(4.2) \quad U_e(\varepsilon) = \{0 \leq u_{ij} < \varepsilon \text{ for } \{i, j\} \in e, 0 < u_{kl} < 1 \text{ for } \{k, l\} \in \alpha \setminus e\} \subset \mathfrak{M}_{0,S}^\delta(\mathbb{R}) .$$

Since we know that $\{u_{ij}, \{i, j\} \in \alpha\}$ defines a local coordinate system on $\mathfrak{M}_{0,S}^\delta(\mathbb{R})$ (proposition 2.18), $U_e(\varepsilon)$ is diffeomorphic to a chart $U_{\ell-k,k} = \mathbb{R}^{\ell-k} \times \mathbb{R}_+^k$ when ε is sufficiently small. We have (c.f., (2.31)):

$$\overline{X}_{S,\delta} = X_{S,\delta} \cup \bigcup_{k \geq 1} \bigcup_{e \in \chi_{S,\delta}^k} U_e(\varepsilon) , \quad \text{for some } \varepsilon > 0 .$$

This proves that $\overline{X}_{S,\delta}$ is indeed an analytic manifold with corners, since all transition maps between boundary components of charts are given by permutations of coordinates. The action of the dihedral group of symmetries on $\overline{X}_{S,\delta}$ is a morphism of analytic manifolds with corners.

4.2. Logarithmic singularities and regularisation. We define three sheaves of functions on an analytic manifold with corners X which have singularities along its boundary ∂X . They are:

$$\mathcal{F}^{\text{an}} \subset \mathcal{F}^{\text{log}} \subset \mathcal{F}_p^{\text{log}} ,$$

where \mathcal{F}^{an} denotes the sheaf of analytic functions on X , \mathcal{F}^{log} denotes the sheaf of functions with logarithmic singularities along ∂X , and $\mathcal{F}_p^{\text{log}}$ denotes the sheaf of functions with both logarithmic singularities and ordinary poles along ∂X .

More precisely, let $p, q \geq 0$ where $n = p+q \geq 1$, and let x_1, \dots, x_n be coordinates on \mathbb{R}^n such that $U_{p,q} = \mathbb{R}^p \times \mathbb{R}_+^q = \{x_1 \geq 0, \dots, x_q \geq 0\}$. Then we define

$$\mathcal{F}^{\text{an}}(U_{p,q}) \subset \mathbb{R}[[x_1, \dots, x_n]] ,$$

to be the ring of convergent Taylor series in the variables x_1, \dots, x_n . Next, we define

$$(4.3) \quad \begin{aligned} \mathcal{F}^{\text{log}}(U_{p,q}) &= \mathcal{F}^{\text{an}}(U_{p,q})[\log x_1, \dots, \log x_q] , \\ \mathcal{F}_p^{\text{log}}(U_{p,q}) &= \mathcal{F}^{\text{an}}(U_{p,q})[x_1^{-1}, \dots, x_q^{-1}, \log x_1, \dots, \log x_q] , \end{aligned}$$

where $\log x_i$ is the principal branch of the logarithm along \mathbb{R}_+ . It follows by a monodromy argument that the functions $\log x_i$ are linearly independent over the

ring $\mathcal{F}^{\text{an}}(U_{p,q})$. Similar rings of functions in one variable (polynomials in $\log x$ with analytic coefficients) were considered in [BM].

For each $1 \leq i \leq n$, let v_i denote the valuation map on $\mathcal{F}^{\text{an}}(U_{p,q})$ which associates to any function the order of its vanishing along $x_i = 0$. It extends to a valuation

$$v_i : \mathcal{F}_p^{\text{log}}(U_{p,q}) \longrightarrow \mathbb{Z},$$

once we have adopted the convention that $v_i(\log x_i) = 0$.

Lemma 4.2. *Let X denote an analytic manifold with corners. Then \mathcal{F}^{an} , \mathcal{F}^{log} , and $\mathcal{F}_p^{\text{log}}$ define sheaves on X , and for each boundary component D of ∂X , the valuation map v_D on $\mathcal{F}_p^{\text{log}}$ is well-defined.*

Proof. Let $\phi \in \text{Hom}_{\text{an}}(U_{p,q}, U_{p,q})$. It suffices to check that the composition with ϕ preserves $\mathcal{F}^{\text{log}}(U_{p,q})$. Let $\phi = (\phi_1, \dots, \phi_n)$. By definition 4.1, and by permuting the coordinates if necessary, we have

$$(4.4) \quad \phi_i(x_1, \dots, x_n) = x_i f_i(x_1, \dots, x_n), \quad \text{for } 1 \leq i \leq q,$$

where $f_i \in \mathcal{F}^{\text{an}}(U_{p,q})$. This implies that $f_i(x_1, \dots, x_n) \geq 0$ for all $(x_1, \dots, x_n) \in U_{p,q}$, and furthermore, $v_i(f_i) = 0$. It follows that

$$\log(\phi_i(x_1, \dots, x_n)) = \log(x_i) + \log(f_i(x_1, \dots, x_n)), \quad \text{for } 1 \leq i \leq q,$$

where $\log f_i \in \mathcal{F}^{\text{an}}(U_{p,q})$ is analytic. It follows that $\phi^* \mathcal{F}^{\text{log}}(U_{p,q}) \subset \mathcal{F}^{\text{log}}(U_{p,q})$, and, similarly, $\phi^* \mathcal{F}_p^{\text{log}}(U_{p,q}) \subset \mathcal{F}_p^{\text{log}}(U_{p,q})$. The fact that the valuations are well-defined along the components of ∂X follows immediately from (4.4). \square

We can define the regularised value of a function along boundary components of X by formally setting the functions $\log x_i$ to 0, for $1 \leq i \leq q$, on each chart $U_{p,q}$ of X .

Definition 4.3. Let $f \in \mathcal{F}^{\text{log}}(U_{p,q})$, and let $1 \leq l \leq q$. We can write

$$f = \sum_{I=(i_1, \dots, i_l) \in \mathbb{N}^l} f_I \log^{i_1} x_1 \dots \log^{i_l} x_l, \quad \text{where } f_I \in \mathcal{F}^{\text{log}}(U_{p+l, q-l}),$$

and f_I is zero for all but finitely many indices I . The *regularized value of f along $D = \{(x_1, \dots, x_n) : x_1 = \dots = x_l = 0\} \subset \partial^l U_{p,q}$* is defined to be:

$$\text{Reg}(f, D) = f_{(0, \dots, 0)}(0, \dots, 0, x_{l+1}, \dots, x_q, x_{q+1}, \dots, x_n),$$

viewed as a function on $D \cong U_{p, q-l}$. By construction, $\text{Reg}(f, D) \in \mathcal{F}^{\text{log}}(D)$.

Definition-Proposition 4.4. Let X denote an analytic manifold with corners, and let $D \subset \partial^l X$ denote any boundary component of X . Then there is a well-defined regularisation map along the component D :

$$\text{Reg}(\bullet, D) : \mathcal{F}^{\text{log}}(X) \longrightarrow \mathcal{F}^{\text{log}}(D).$$

Proof. The transition maps are compatible with logarithmic regularisation by definition 4.1. Let $\phi \in \text{Hom}_{\text{an}}(U_{p,q}, U_{p,q})$. Then, up to permuting coordinates, ϕ is of the form $\phi = (x_1(1 + x_1 g_1), \dots, x_q(1 + x_q g_q), \phi_{q+1}, \dots, \phi_n)$. It follows that

$$\log \phi_i = \log x_i + \log(1 + x_i g_i), \quad \text{for } 1 \leq i \leq q,$$

and the term $\log(1 + x_i g_i)$ vanishes at $x_i = 0$. It follows that logarithmic regularisation along $x_i = 0$ is well-defined for $1 \leq i \leq q$. By regularising with respect to one variable at a time, it follows that regularisation along an arbitrary boundary component $D \subset \partial^l X$ is well-defined also. \square

Remark 4.5. Clearly we can extend the regularisation map for polar singularities

$$\text{Reg}(\bullet, D) : \mathcal{F}_p^{\log}(X) \longrightarrow \mathcal{F}_p^{\log}(D) ,$$

by mapping all negative powers of coordinates x_1, \dots, x_l to zero also (this is just a map of constants as defined in §3.4).

4.3. Fuchsian differential equations in several complex variables. Consider the open complex affine space obtained by complexifying $U_{p,q}$:

$$\mathbb{C}^{p+q} \setminus \{z_1 \dots z_q = 0\} ,$$

and let $V_{p,q}$ denote an open polydisk neighbourhood of the origin contained in $\mathbb{C}^{p+q} \setminus \{z_1 \dots z_q = 0\}$. We require a generalised Fuchs' theorem which we solve locally on the spaces $V_{p,q}$. Let $m \geq 1$, and consider the differential equation:

$$(4.5) \quad dF = \Omega F ,$$

where F takes values in the set of $m \times m$ complex matrices $M_m(\mathbb{C})$, and where

$$(4.6) \quad \Omega = \sum_{i=1}^n N_i \frac{dz_i}{z_i} + A_i dz_i .$$

Here, $N_i \in M_m(\mathbb{C})$ are constant matrices, and each A_i is a holomorphic function on $V_{p,q}$, which takes values in $M_m(\mathbb{C})$. Assume that Ω is integrable, *i.e.*,

$$d\Omega = \Omega \wedge \Omega .$$

This implies, in particular, that the matrices N_i commute:

$$(4.7) \quad [N_i, N_j] = 0 \quad \text{for all } 1 \leq i, j \leq n .$$

Let us write $n = p + q \geq 1$, and suppose that $N_i = 0$ for all $q + 1 \leq i \leq n$. The form Ω is continuous on $V_{p,q}$. Let us fix branches of the logarithm $\log z_i$ for $i = 1, \dots, q$ on $V_{p,q}$. In practice, we will choose a real subspace $\mathbb{R}^p \times \mathbb{R}_+^q \cong U_{p,q} \subset V_{p,q}$ and take the unique branches of the logarithm which are real-valued on $U_{p,q}$. The function

$$D = \exp\left(\sum_{i=1}^q N_i \log z_i\right) ,$$

is a well-defined multi-valued function on $V_{p,q}$ because the matrices N_i commute. The following result is a generalized Fuchs' theorem in many complex variables. Similar situations have been considered in [De3, Yo].

Theorem 4.6. *Suppose that for each $1 \leq i \leq n$, no pair of eigenvalues of the matrix N_i differ by a non-zero integer. Let $H_0 \in M_m(\mathbb{C})$ be any constant matrix. Then (4.5) has a unique solution*

$$F = H D ,$$

where $H : V_{p,q} \rightarrow M_m(\mathbb{C})$ is holomorphic and takes the value H_0 at the origin.

Proof. The matrix D is invertible, and is a solution to the differential equation

$$dD = \left(\sum_{i=1}^n N_i \frac{dz_i}{z_i}\right) D .$$

It follows that $F = HD$ is a solution of (4.5) if and only if

$$(4.8) \quad dH = \sum_{i=1}^n [N_i, H] \frac{dz_i}{z_i} + A_i H dz_i .$$

If we write $\partial_k = \partial/\partial z_k$, then this is equivalent to the set of equations

$$(4.9) \quad \partial_k H = [N_k, H] \frac{1}{z_k} + A_k H, \quad \text{for } 1 \leq k \leq n.$$

A solution H is holomorphic on $V_{p,q}$ if and only if it can be written as a power series

$$(4.10) \quad H = \sum_{0 \leq i_1, \dots, 0 \leq i_n} H_{(i_1, \dots, i_n)} z_1^{i_1} \dots z_n^{i_n},$$

where the coefficients $H_{(i_1, \dots, i_n)} \in M_m(\mathbb{C})$ satisfy a growth condition. By substituting such a power series expansion into (4.9) and considering the coefficient of $z_1^{i_1} \dots z_n^{i_n}$, we obtain the following recurrence relations:

$$(4.11) \quad (i_k + 1 - \text{ad}(N_k)) H_{(i_1, \dots, i_k+1, \dots, i_n)} = \sum_{0 \leq j_1 \leq i_1, \dots, 0 \leq j_n \leq i_n} (A_k)_{(j_1, \dots, j_n)} H_{(i_1-j_1, \dots, i_n-j_n)}$$

for each $1 \leq k \leq n$, where $(A_k)_{(j_1, \dots, j_n)}$ are the coefficients in the power series expansion of A_k . Now consider a matrix $M \in M_m(\mathbb{C})$. If we denote the eigenvalues of M by $\alpha_1, \dots, \alpha_m$, then the eigenvalues of $\text{ad } M$ are $\alpha_i - \alpha_j$. The assumption on the eigenvalues of N_i is therefore equivalent to the invertibility of the operators

$$(m - \text{ad}(N_k)) \quad \text{for all } m \in \mathbb{N},$$

and for each $1 \leq k \leq n$. The operator on the left hand side of (4.11) is therefore invertible, so we can solve (4.11) iteratively, provided that these equations are compatible. This means that we must show that the two different ways of obtaining $H_{(i_1, \dots, i_k+1, \dots, i_l+1, \dots, i_n)}$ by applying (4.11) first for k and then for l , or the other way round, both lead to the same answer. This is equivalent to the integrability of the form Ω . In order to see this, write $\Omega = \sum_i \Omega_i dz_i$, where $\Omega_i = R_i + A_i$, and $R_i = N_i/z_i$, for $1 \leq i \leq n$. The integrability of Ω and the commutativity of the R_i implies the following equations for all $1 \leq i, j \leq n$:

$$\begin{aligned} \partial_j \Omega_i &= \partial_i \Omega_j + [\Omega_j, \Omega_i], \\ \partial_j R_i &= \partial_i R_j + [R_j, R_i]. \end{aligned}$$

It follows that the expression

$$\phi_{ij}(M) = (\partial_j \Omega_i + \Omega_i \Omega_j) M - \Omega_i M R_j - \Omega_j M R_i + M(R_j R_i - \partial_j R_i)$$

is symmetric in i, j for all matrices $M \in M_m(\mathbb{C})$. But equations (4.9) are precisely the set of equations $\partial_i H = \Omega_i H - H R_i$ for $1 \leq i \leq n$. It follows, on applying ∂_j to each equation, that

$$\partial_j \partial_i H = \phi_{ij} H \quad \text{for all } 1 \leq i, j \leq n.$$

One can check by differentiating a truncated power series expansion for H that the compatibility of the equations (4.11) up to a given weight is a consequence of the symmetry of the operators ϕ_{kl} , for all $1 \leq k, l \leq n$. We can therefore solve (4.11) recursively to obtain a solution of (4.8) of the form (4.10). It remains to check that the function H defined in this manner is holomorphic on $V_{p,q}$. Since the series A_k for $1 \leq k \leq n$ are holomorphic on the polydisk $V_{p,q}$, there exist constants $r_1, \dots, r_n > 0$ and a constant $c > 0$ such that

$$(4.12) \quad \|(A_k)_{(i_1, \dots, i_n)}\| \leq c r_1^{i_1} \dots r_n^{i_n} \quad \text{for all } 1 \leq k \leq n.$$

For $m \geq 1$, let $\varepsilon_m = \sup_{1 \leq k \leq n} \|(m - \text{ad } N_k)\|^{-1}$. By the assumption on the eigenvalues of N_k and the remarks above, $\varepsilon_m \rightarrow 0$ as $m \rightarrow \infty$. It follows from (4.11) that

$$(4.13) \quad \|H_{(i_1, \dots, i_k+1, \dots, i_n)}\| \leq \varepsilon_{i_k+1} \sum_{0 \leq j_i \leq i_i} \|(A_k)_{(j_1, \dots, j_n)}\| \|H_{(i_1-j_1, \dots, i_n-j_n)}\|.$$

Now let $s_k > r_k$, for $1 \leq k \leq n$, and let m be sufficiently large such that $\varepsilon_m c \prod_{i=1}^n \left(\frac{s_i}{s_i - r_i}\right) < 1$. Set

$$e = \sup_{0 \leq i_1, \dots, i_n \leq m_r} \frac{\|H_{(i_1, \dots, i_n)}\|}{s_1^{i_1} \dots s_n^{i_n}} < \infty.$$

Let $M \geq m$, and suppose by induction that $\|H_{(i_1, \dots, i_n)}\| \leq e s_1^{i_1} \dots s_n^{i_n}$ for all $0 \leq i_1, \dots, i_n \leq M$. This is true when $M = m$ by the definition of e . Then, by applying (4.12), we deduce from (4.13) that

$$\begin{aligned} \|H_{(i_1, \dots, M+1, \dots, i_n)}\| &\leq \varepsilon_{M+1} \sum_{0 \leq j_1 \leq i_1, \dots, 0 \leq j_n \leq i_n} c e \left(\frac{r_1}{s_1}\right)^{j_1} \dots \left(\frac{r_n}{s_n}\right)^{j_n} s_1^{i_1} \dots s_n^{i_n} \\ &\leq \varepsilon_{M+1} c e \prod_{i=1}^n \left(\frac{s_i}{s_i - r_i}\right) s_1^{i_1} \dots s_n^{i_n} \leq e s_1^{i_1} \dots s_n^{i_n}. \end{aligned}$$

By induction we deduce that $\|H_{(i_1, \dots, i_n)}\| \leq e s_1^{i_1} \dots s_n^{i_n}$ for all (i_1, \dots, i_n) . This holds for any set of constants s_1, \dots, s_n satisfying $s_i > r_i$, which proves that H is holomorphic on $V_{p,q}$, as required. \square

We will be interested in the case where the matrices N_i are all nilpotent. It then follows that the matrix

$$D = \exp \left(\sum_{i=1}^q N_i \log z_i \right)$$

has coefficients which are polynomials in $\log z_i$. Since all eigenvalues of N_i are 0, the condition of the previous theorem is satisfied, and therefore there exists a matrix solution F to equation (4.5) whose entries F_{ab} are polynomials in $\log z_1, \dots, \log z_q$ whose coefficients are convergent Taylor series in z_1, \dots, z_n :

$$F_{ab} \subset \mathbb{C}[[z_1, \dots, z_n]][\log z_1, \dots, \log z_q].$$

Definition 4.7. Let X denote an analytic manifold with corners. An integrable 1-form Ω defined on X is *unipotent of Fuchs' type* if, locally on each chart of the form $U_{p,q}$, Ω restricts to a 1-form of type (4.6), where the matrices N_i are nilpotent.

As remarked in §4.2, there are canonical branches of the functions $\log z_i$ on local charts of X . The solutions to (4.5) will therefore be real-valued on X .

Corollary 4.8. *Let Ω be a real-valued unipotent integrable 1-form of Fuchs' type on X . Suppose that X is simply connected. Then any solution (F_{ab}) to (4.5) defined in the neighbourhood of any point $x \in X$ extends over the whole of X . This gives a global solution of (4.5) whose coefficients satisfy $F_{ab} \in \Gamma(X, \mathcal{F}^{\log})$.*

4.4. Stokes' theorem with logarithmic singularities. The key argument in our proof of the main theorem is to apply a version of Stokes' theorem to the manifold with corners $\overline{X}_{S,\delta}$. This requires integrating functions which have logarithmic singularities along the boundary.

Lemma 4.9. *Let X denote a compact analytic manifold with corners of dimension n . Let $\psi \in \Omega^n(X)$ denote an n -form on X whose coefficients lie in \mathcal{F}_p^{\log} . Then ψ is absolutely integrable on X if and only if ψ has no poles along ∂X .*

Proof. If ψ has a pole of order $k \geq 1$ along some component of ∂X , then there is a chart on X of the form $U_{p,1}$ such that $\psi = f dx_1 \dots dx_n$, where f can be written

$$f(x_1, \dots, x_n) = \frac{1}{x_1^k} \sum_{i=0}^N f_i(x_2, \dots, x_n) \log^i x_1 + \frac{1}{x_1^{k-1}} \sum_{i=0}^M g_i(x_1, \dots, x_n) \log^i x_1,$$

where $f_i, g_i \in \mathcal{F}^{\text{an}}(U_{p,q})$ are analytic on $x_1 > 0, \dots, x_n > 0$, and f_N is not identically zero. Since the term $(\log x_1)^N$ dominates the other powers of $\log x_1$ near $x_1 = 0$, it follows by continuity that there is a small box

$$B(\varepsilon) = \{(x_1, \dots, x_n) : x_1 \in [0, \varepsilon], x_2 - \alpha_2, \dots, x_n - \alpha_n \in [-\varepsilon, \varepsilon]\},$$

where $\alpha_2, \dots, \alpha_n > 0$, and a constant $c > 0$ such that

$$|f| \geq \frac{c}{x_1^k} |\log x_1|^N,$$

for all $(x_1, x_2, \dots, x_n) \in B(\varepsilon)$ whenever $\varepsilon > 0$ is sufficiently small. It follows that

$$\int_X |f| dx_1 \dots dx_n \geq c(2\varepsilon)^{n-1} \int_0^\varepsilon \frac{1}{x_1^k} |\log x_1|^N dx_1 = \infty,$$

and therefore ψ is not absolutely integrable.

Now suppose that ψ has no poles along ∂X . Then in each small chart of the form $U_{p,q}$, we can write $\psi = f(x_1, \dots, x_n) dx_1 \dots dx_n$, where

$$f(x_1, \dots, x_n) = \sum_{I=(i_1, \dots, i_q)} (\log x_1)^{i_1} \dots (\log x_q)^{i_q} f_I(x_1, \dots, x_n),$$

where $f_I(x_1, \dots, x_n) \in \mathcal{F}^{\text{an}}(U_{p,q})$, and almost all f_I are identically zero. But the function $\log x$ is integrable on any interval $[0, t)$, where $t > 0$, and since sums and products of integrable functions are integrable, it follows that f is integrable locally. Since X is compact, we can find a finite partition of unity on X , and deduce that f is absolutely integrable over the whole of X . \square

We can therefore integrate functions which have at most logarithmic singularities. The following lemma implies that primitives of functions on X which have at most logarithmic singularities extend continuously to ∂X . The essential point is that the 1-form $\log x dx$ on \mathbb{R}_+ has a logarithmic singularity at 0, but its primitive, $x \log x - x + c$, is continuous at $x = 0$.

Lemma 4.10. *Let X be an analytic manifold with corners. Let $\psi \in \Omega^n(X)$ have at most logarithmic singularities along ∂X , and let $\Psi \in \Omega^{n-1}(X)$ denote a primitive of ψ which has no poles along ∂X . Then Ψ is continuous on the interior of ∂X .*

Proof. It suffices to prove the result on each chart of X isomorphic to $U_{p,q}$ with coordinates x_1, \dots, x_n as above. Let $\psi = f dx_1 \dots dx_n$, where $f \in \mathcal{F}^{\log}(U_{p,q})$. We write $\Psi = \sum_{i=1}^n (-1)^{i-1} F_i dx_1 \dots \widehat{dx}_i \dots dx_n$, where $F_i \in \mathcal{F}^{\log}(U_{p,q})$ for $1 \leq i \leq n$. Let

$$F_i = \sum_{k \geq 0} \log^k x_i F_{i,k} ,$$

where $F_{i,k} \in \mathcal{F}^{\log}(U_{p,q})$ is analytic in the coordinate x_i and is zero for all but finitely many indices k . Since $\sum_{i=1}^n \partial F_i / \partial x_i = f$, we have

$$\sum_{i=1}^n \sum_{k \geq 1} \frac{k \log^{k-1} x_i}{x_i} F_{i,k}(x_1, \dots, x_{i-1}, 0, x_{i+1}, \dots, x_n) \in \mathcal{F}^{\log}(U_{p,q}) .$$

This implies that $F_{i,k}(x_1, \dots, x_{i-1}, 0, x_{i+1}, \dots, x_n) = 0$ for all $1 \leq i \leq n$, $k \geq 1$, and therefore $F_i \in \mathbb{C}[\log x_1, \dots, x_i \log x_i, \dots, \log x_n][[x_1, \dots, x_n]]$. It follows that

$$\Psi \Big|_{x_i=0} = (-1)^{i-1} F_i \Big|_{x_i=0} dx_1 \dots \widehat{dx}_i \dots dx_n$$

is continuous for all $1 \leq i \leq n$. Thus Ψ is continuous along the interior of ∂X . \square

We can now state the following version of Stokes' theorem.

Theorem 4.11. *Let X denote a compact analytic manifold with corners of dimension n . Let $\psi \in \Omega^n(X)$ be an n -form such that ψ has no poles along ∂X , and let $\Psi \in \Omega^{n-1}(X)$ be a primitive of ψ such that Ψ has no poles along ∂X either. Then Ψ extends continuously to ∂X , and*

$$\int_X \psi = \int_{\partial X} \Psi ,$$

where both integrals are finite.

Proof. Let $U_{p,q}(\varepsilon) = \mathbb{R}^p \times \mathbb{R}_\varepsilon^q$ where $\mathbb{R}_\varepsilon = \{x \in \mathbb{R} : x \geq \varepsilon\}$. By lemma 4.9, ψ is integrable on X . We know that Ψ extends continuously to ∂X by the previous lemma. On each small chart of X we can apply Stokes' theorem:

$$\int_{U_{p,q}} \psi = \lim_{\varepsilon \rightarrow 0} \int_{U_{p,q}(\varepsilon)} \psi = \lim_{\varepsilon \rightarrow 0} \int_{\partial U_{p,q}(\varepsilon)} \Psi = \int_{\partial U_{p,q}} \Psi ,$$

and all terms are finite. Since X is compact, we can find a finite partition of unity and apply the above identity locally. The result then follows in exactly the same way as the usual proof of Stokes' theorem. \square

In the case which interests us, when $X = \overline{X}_{S,\delta}$, we can define the following exhaustion of the polytopes $\overline{X}_{S,\delta}$. For all small $\varepsilon > 0$, we set

$$\overline{X}_{S,\delta}^\varepsilon = \{u_{ij} \geq \varepsilon, \quad \{i, j\} \in \chi_{S,\delta}\} .$$

The required version of Stokes' theorem is then immediate:

$$\int_{X_{S,\delta}} \psi = \lim_{\varepsilon \rightarrow 0} \int_{\overline{X}_{S,\delta}^\varepsilon} \psi = \lim_{\varepsilon \rightarrow 0} \int_{\partial \overline{X}_{S,\delta}^\varepsilon} \Psi = \int_{\partial \overline{X}_S} \Psi .$$

5. HYPERLOGARITHMS

We give an explicit description of the constructions in the previous two sections when the dimension is 1, *i.e.*, when M is the affine line \mathbb{A}^1 minus $N + 1$ fixed points $\sigma_0, \dots, \sigma_N$. However, we need to consider iterated integrals whose path of integration has endpoints at one of the removed points σ_i , and so do not necessarily converge. This requires a regularisation procedure which can be solved for all iterated integrals simultaneously by considering their generating series.

5.1. Hyperlogarithms and differential equations. Let $N \geq 1$, and let $A = \{a_0, \dots, a_N\}$ be an alphabet with $N + 1$ letters. We fix any injective map of sets $j : A \hookrightarrow \mathbb{C}$, and set $\sigma_0 = j(a_0), \dots, \sigma_N = j(a_N)$. Let Σ denote the set $j(A) \cup \{\infty\}$, and let $D = \mathbb{P}^1(\mathbb{C}) \setminus \Sigma$ denote the complex plane with the points σ_k removed. Consider the following formal differential equation:

$$(5.1) \quad \frac{\partial}{\partial z} F(z) = \sum_{i=0}^N \frac{a_i}{z - \sigma_i} F(z) ,$$

which is an equation of Fuchs type, whose singularities are simple poles in Σ . Let $F(z)$ be a solution on D taking values in $\mathbb{C}\langle\langle A \rangle\rangle$. If we write

$$F(z) = \sum_{w \in A^*} F_w(z) w ,$$

then (5.1) is equivalent to the system of equations

$$(5.2) \quad \frac{\partial}{\partial z} F_{a_k w}(z) = \frac{F_w(z)}{z - \sigma_k} ,$$

for all $0 \leq k \leq N$ and all $w \in A^*$, together with the initial equation $\partial F_1(z)/\partial z = 0$, where 1 denotes the empty word in A^* . The term $F_1(z)$ is therefore constant.

One can construct explicit holomorphic solutions $L_w(z)$ to (5.2) on a certain domain U obtained by cutting \mathbb{C} . These functions extend by analytic continuation to multi-valued functions on the punctured plane D , and can equivalently be regarded as holomorphic functions on a universal covering space $p : \widehat{D} \rightarrow D$. Since no confusion arises, we shall always denote these functions by the same symbol $L_w(z)$. For each $0 \leq k \leq N$, choose closed half-lines $\ell(\sigma_k) \subset \mathbb{C}$ starting at σ_k , such that no two intersect. Let $U = \mathbb{C} \setminus \bigcup_{\sigma_k \in \Sigma} \ell(\sigma_k)$ be the simply-connected open subset of \mathbb{C} obtained by cutting along these half-lines. Fix a branch of $\log(z - \sigma_0)$ on $\mathbb{C} \setminus \ell(\sigma_0)$.

Proposition 5.1. *Equation (5.1) has a unique solution $L(z)$ on U such that*

$$L(z) = f_0(z) \exp(a_0 \log(z - \sigma_0)) ,$$

where $f_0(z)$ is a holomorphic function on $\mathbb{C} \setminus \bigcup_{k \neq 0} \ell(\sigma_k)$ which satisfies $f_0(\sigma_0) = 1$. We write this $L(z) \sim (z - \sigma_0)^{a_0}$ as $z \rightarrow \sigma_0$. Furthermore, every solution of (5.1) which is holomorphic on U can be written $L(z)C$, where $C \in \mathbb{C}\langle\langle X \rangle\rangle$ is a constant series (*i.e.*, depending only on Σ , and not on z).

The proposition can be deduced from theorem 4.6, and a direct solution is given in Gonzalez-Lorca's thesis [GL]. We use another approach here, since we require an explicit formula for the functions $L_w(z)$ which is originally due to Poincaré and Lappo-Danilevsky [P, LD]. First, let A_c^* denote the subset of all words in A^* which do not end in the letter a_0 , and let $\mathbb{C}\langle A_c \rangle \subset \mathbb{C}\langle A \rangle$ denote the sub-vector space they generate. It is easy to verify that $\mathbb{C}\langle A_c \rangle$ is preserved by the shuffle

product. If $w \in A_c^*$ and $w \neq 1$, the limiting condition given in the proposition is just $\lim_{z \rightarrow \sigma_0} L_w(z) = 0$. If we write $w = a_0^{n_r} a_{i_r} a_0^{n_{r-1}} a_{i_{r-1}} \dots a_0^{n_1} a_{i_1}$, where $1 \leq i_1, \dots, i_r \leq N$, then $L_w(z)$ is defined in a neighbourhood of σ_0 by the formula

$$(5.3) \quad \sum_{1 \leq m_1 < \dots < m_r} \frac{(-1)^r}{m_1^{n_1+1} \dots m_r^{n_r+1}} \left(\frac{z-\sigma_0}{\sigma_{i_1}-\sigma_0} \right)^{m_1} \left(\frac{z-\sigma_0}{\sigma_{i_2}-\sigma_0} \right)^{m_2-m_1} \dots \left(\frac{z-\sigma_0}{\sigma_{i_r}-\sigma_0} \right)^{m_r-m_{r-1}}$$

which converges absolutely for $|z-\sigma_0| < \inf\{|\sigma_{i_1}-\sigma_0|, \dots, |\sigma_{i_r}-\sigma_0|\}$. One can easily check that this defines a family of holomorphic functions satisfying the equations (5.2) in this open disk, and that the limiting condition is trivially satisfied.

The functions $L_w(z)$ extend analytically to the whole of U by the recursive integral formula:

$$(5.4) \quad L_{a_k w}(z) = \int_{\sigma_0}^z \frac{L_w(t)}{t - \sigma_k} dt ,$$

which is valid for all $0 \leq k \leq N$ and all $w \in A_c^*$. Since iterated integrals are homomorphisms for the shuffle product (lemma 3.28), we also have

$$(5.5) \quad L_w(z)L_{w'}(z) = L_{w \text{ III } w'}(z) \quad \text{for all } w, w' \in A_c^* ,$$

where L is extended by linearity to all words $w \in \mathbb{C}\langle A_c \rangle$. It follows from the definition of the shuffle product that any word in A^* can be uniquely written as a linear combination of shuffles of a_0^n with words in A_c^* :

$$w = \sum_{n \geq 0} a_0^n \text{ III } v_n , \quad \text{where } v_n \in \mathbb{C}\langle A_c \rangle .$$

We can therefore set

$$L_{a_0}(z) = \log(z - \sigma_0) ,$$

and extend the definition of $L_w(z)$ to all words $w \in A^*$ by demanding that $L_w(z)$ satisfy the shuffle relations $L_w(z)L_{w'}(z) = L_{w \text{ III } w'}(z)$ for all w, w' in A^* . One verifies that the functions $L_w(z)$ can be written in the form (5.4) for all words $w \in A^*$, for $w \neq a_0^n$, and are solutions to (5.2). In order to prove that $f_0(z) = L(z) \exp(-a_0 \log(z - \sigma_0))$ is holomorphic at $z = \sigma_0$, we use the following lemma.

Lemma 5.2. $\sum_{i=0}^n (-1)^i w a_0^{n-i} \text{ III } a_0^i \equiv 0 \pmod{\mathbb{C}\langle A_c^* \rangle}$ for all $w \in A_c^*$.

Proof. Let $\tilde{\partial}_{a_0}$ denote the truncation operator with respect to the letter a_0 defined in §3.1, but which acts by truncation on the right, i.e., $\tilde{\partial}_{a_0} w a_i = \delta_{0i} w$, where δ_{0i} is the Kronecker delta. It is a derivation with respect to III . If we apply it to the left-hand side of the equation, we obtain zero, by the Leibniz formula. This implies that the left hand side is a linear combination of words not ending in a_0 . \square

Remark 5.3. The operators $\tilde{\partial}_{a_i}$ are related to the ‘dérivations étrangères’ defined by Ecalle [E].

Using the fact that $a_0^{\text{III } i} = i! a_0^i$, we have

$$f_0(z) = L(z) \exp(-a_0 \log(z - \sigma_0)) = \sum_{w \in A^*} L_w(z) w \sum_{i \geq 0} (-1)^i a_0^i L_{a_0^i}(z) .$$

It follows from the previous lemma and the shuffle relations for the functions $L_w(z)$, that the coefficient of each word $w a_0^n$, where $w \in A_c^*$ and $n \geq 0$, is a linear combination of $L_{w'}(z)$, where $w' \in A_c^*$. These are holomorphic at $z = \sigma_0$ by construction, and this proves the regularity condition for $f_0(z)$.

In order to prove the uniqueness statement in the proposition, let $K(z)$ be any other solution of (5.1) which is holomorphic on U . The series $L(z)$ defined above is invertible, as its leading coefficient is the constant function 1. Let $F(z) = L(z)^{-1}K(z)$. On differentiating the equation $K(z) = L(z)F(z)$, we obtain

$$\sum_{i=0}^N \frac{a_i}{z - \sigma_i} K(z) = \sum_{i=0}^N \frac{a_i}{z - \sigma_i} L(z)F(z) + L(z)F'(z) ,$$

by (5.1), and therefore $L(z)F'(z) = 0$. Since $L(z)$ is invertible, $F'(z) = 0$, and so $F(z)$ is constant. This completes the proof of the proposition.

Remark 5.4. The functions $L_w(z)$ are known as *hyperlogarithms* and were originally defined by Poincaré and Lappo-Danilevsky. They were recently resurrected by Aomoto [Ao1-3], Ecalle [E], and Goncharov [Go1-3]. It is clear that $L_1(z) = 1$, and

$$\begin{aligned} L_{a_i^n}(z) &= \frac{1}{n!} \log^n \left(\frac{z - \sigma_i}{\sigma_0 - \sigma_i} \right) \quad \text{if } i \geq 1, \\ L_{a_0^n}(z) &= \frac{1}{n!} \log^n(z - \sigma_0) , \end{aligned}$$

for all $n \in \mathbb{N}$. Note that $L_{a_0^n}(z)$ depends on the choice of branch of $\log(z - \sigma_0)$ which was fixed previously, but that the functions $L_{a_i^n}(z)$ do not. They are the unique branches which satisfy the limiting condition $L_{a_i^n}(\sigma_0) = 0$.

Given a branch of $\log(z - \sigma_k)$ on $\mathbb{C} \setminus \ell(\sigma_k)$ for each $1 \leq k \leq N$, we obtain by symmetry a solution to (5.1) corresponding to each singularity.

Corollary 5.5. *For every $0 \leq k \leq N$, there exists a unique solution $L^{\sigma_k}(z)$ of equation (5.2) on U such that*

$$L^{\sigma_k}(z) = f_k(z) \exp(a_k \log(z - \sigma_k)) ,$$

where $f_k(z)$ is holomorphic on $\mathbb{C} \setminus \bigcup_{i \neq k} \ell(\sigma_i)$ and satisfies $f_k(\sigma_k) = 1$.

The quotient of any two such solutions is a constant non-commutative series known as a regularised zeta series. Using these series, one can determine the monodromy of hyperlogarithms explicitly ([Br2]).

5.2. The bar construction on $\mathbb{P}^1 \setminus \Sigma$. In this situation, the variant of the bar construction defined in §3 is very easy to describe. Let k denote any subfield of \mathbb{C} which contains $\sigma_0, \dots, \sigma_N$. The ring of regular functions on $\mathbb{P}^1 \setminus \Sigma$ is simply

$$\mathcal{O}_\Sigma = k \left[z, \left(\frac{1}{z - \sigma_j} \right)_{0 \leq j \leq N} \right] .$$

Since $\mathbb{P}^1 \setminus \Sigma$ is of dimension one, the integrability condition is trivially satisfied. Let $A^\vee = \{\psi_0, \dots, \psi_N\}$, where $\psi_i = d \log(z - \sigma_i)$, for $0 \leq i \leq N$. The cohomology classes of the forms ψ_i form a k -basis for $H^1(\mathbb{P}^1 \setminus \Sigma)$. Clearly $\psi_i \wedge \psi_j = 0$ for all $0 \leq i, j \leq N$, and therefore $B(\mathbb{P}^1 \setminus \Sigma)$ is a shuffle algebra

$$(5.6) \quad B(\mathbb{P}^1 \setminus \Sigma) = \mathcal{O}_\Sigma \otimes_k k\langle A^\vee \rangle ,$$

equipped with the derivation

$$(5.7) \quad d = \frac{d}{dz} \otimes 1 + \sum_{i=0}^N \left(\frac{1}{z - \sigma_i} \right) \otimes \partial_{\psi_i} ,$$

where the truncation operators ∂_{ψ_i} were defined in §3.1. Let $L(\mathbb{P}^1 \setminus \Sigma)$ denote the \mathcal{O}_Σ -algebra generated by the coefficients of a solution L to (5.1). The analogue of the map (3.26) is the differential homomorphism:

$$(5.8) \quad \begin{aligned} \rho : B(\mathbb{P}^1 \setminus \Sigma) &\longrightarrow L(\mathbb{P}^1 \setminus \Sigma) \\ w &\longmapsto L_w(z) , \end{aligned}$$

which is the identity on \mathcal{O}_Σ . Theorem 3.26 implies that this map is an isomorphism.

Corollary 5.6. *The functions $L_w(z)$, for $w \in A^*$, are linearly independent over \mathcal{O}_Σ . Every function in $L(\mathbb{P}^1 \setminus \Sigma)$ has a primitive which is unique up to a constant.*

The construction of the functions $L_w(z)$ used a decomposition of $B(\mathbb{P}^1 \setminus \Sigma)$ into convergent and non-convergent parts. This used the fact that the map

$$(u \otimes v \mapsto u \boxplus v) : \mathbb{Z}\langle A_c \rangle \otimes \mathbb{Z}\langle a_0 \rangle \rightarrow \mathbb{Z}\langle A \rangle ,$$

is an isomorphism of algebras. We can therefore define

$$(5.9) \quad B_{\sigma_0}(\mathbb{P}^1 \setminus \Sigma) = \mathcal{O}_\Sigma \langle A_c \rangle ,$$

to be the sub-algebra of convergent iterated integrals (indexed by words not ending in a_0). It is a differential algebra for the derivation d defined in (5.7). We have

$$B(\mathbb{P}^1 \setminus \Sigma) \cong B_{\sigma_0}(\mathbb{P}^1 \setminus \Sigma) \otimes_{k[z, 1/(z-\sigma_0)]} B(\mathbb{P}^1 \setminus \{\sigma_0, \infty\}) .$$

There is a corresponding decomposition

$$L(\mathbb{P}^1 \setminus \Sigma) = L_{\sigma_0}(\mathbb{P}^1 \setminus \Sigma) \otimes_{k[z, 1/(z-\sigma_0)]} L(\mathbb{P}^1 \setminus \{\sigma_0, \infty\}) ,$$

where $L(\mathbb{P}^1 \setminus \{\sigma_0, \infty\}) \cong k[z, 1/(z-\sigma_0), \log(z-\sigma_0)]$. Correspondingly, the hyperlogarithm realisation (5.8) decomposes as a product $\rho = \rho_{\sigma_0} \otimes \rho'$, where

$$\rho_{\sigma_0}(w) = \int_{\sigma_0}^z w , \quad \text{for all } w \in A_c .$$

This is a convergent iterated integral, even though the base point σ_0 does not lie in the space $\mathbb{P}^1 \setminus \Sigma$. The logarithmic divergences are completely determined by the realisation $\rho' : B(\mathbb{P}^1 \setminus \{\sigma_0, \infty\}) \rightarrow L(\mathbb{P}^1 \setminus \{\sigma_0, \infty\})$, where $\rho'(a_0) = \log(z-\sigma_0)$.

Remark 5.7. In general, the points $\sigma_0, \dots, \sigma_N$ will not be arranged symmetrically. In this case, one needs to do a genuine analytic continuation of the functions $L_w(z)$, since the formula (5.3) is not valid outside its radius of convergence. Lappo-Danilevsky described a technique for dealing with this situation, which is described in [Br2]. This extra complication will not arise in the present context.

5.3. Quotients of the hyperlogarithm equation. Now we shall consider the case where the coefficients a_i in (5.1) satisfy relations. Therefore, let $A = \{a_0, \dots, a_N\}$ be an alphabet with $N+1$ letters as before, and consider an ideal

$$I \subset \mathbb{C}\langle a_0, \dots, a_N \rangle .$$

Typically, I will be generated by commutators of the form $[a_i, a_j]$ for $i \neq j$. It defines a closed ideal we also denote by I in the completed algebra $\mathbb{C}\langle\langle A \rangle\rangle$. Let

$$\pi : \mathbb{C}\langle\langle A \rangle\rangle \longrightarrow \mathbb{C}\langle\langle A \rangle\rangle / I$$

denote the quotient map. Consider the analogue of equation (5.1):

$$(5.10) \quad \frac{\partial}{\partial z} F(z) = \sum_{i=0}^N \frac{\pi(a_i)}{z - \sigma_i} F(z) ,$$

where, this time, F takes values in the quotient ring $\mathbb{C}\langle\langle A \rangle\rangle/I$. An equation of this type will be called a *hyperlogarithm quotient* equation.

Corollary 5.8. *There exists a unique solution F to the hyperlogarithm quotient equation (5.10) with solutions in $\mathbb{C}\langle\langle A \rangle\rangle/I$ such that $F(z) \sim (z - \sigma_0)^{\pi(a_0)}$ as $z \rightarrow \sigma_0$.*

Proof. The existence follows immediately from proposition 5.1, on applying π to a solution of (5.1). The uniqueness is proved in the same way. \square

Now let $L(I)$ denote the \mathcal{O}_Σ -module of functions generated by the coefficients of a solution F to (5.10). It is a differential submodule of $L(\mathbb{P}^1 \setminus \Sigma)$. More precisely,

$$L(I) \cong \mathcal{O}_\Sigma \otimes (\mathbb{C}\langle A \rangle/I)^\vee \subset \mathcal{O}_\Sigma \otimes (\mathbb{C}\langle A \rangle)^\vee \cong L(\mathbb{P}^1 \setminus \Sigma).$$

It follows that the coefficients of solutions to (5.10) are linear combinations of hyperlogarithms. If I is a Hopf ideal, *i.e.*, $\Gamma I \subset 1 \otimes I + I \otimes 1$, then $L(I)$ is an algebra by duality. Theorem 3.26 immediately implies the following corollary.

Corollary 5.9. *Suppose that I is a Hopf ideal. In this case, $L(I)$ is a unipotent extension of \mathcal{O}_Σ . In particular, it is a differentially simple polynomial algebra over \mathcal{O}_Σ whose ring of constants is k .*

As an example, consider the equation:

$$\frac{dF}{dz} = \left(\frac{a_0}{z} + \frac{a_1}{z-1} \right) F$$

on $\mathbb{P}^1 \setminus \{0, 1, \infty\}$, and let $I \subset \mathbb{C}\langle a_0, a_1 \rangle$ denote the ideal generated by $[a_0, a_1]$. Then $F = \exp(a_0 \log z + a_1 \log(z-1))$ is the unique solution satisfying $F \sim \exp(a_0 \log z)$ as $z \rightarrow 0$. The differential algebra $L(I)$ is just $\mathbb{C}[z, 1/z, 1/(z-1), \log z, \log(z-1)]$.

5.4. Multiple polylogarithms and hyperlogarithms. We recall the definition of the multiple polylogarithm functions, which were defined by Goncharov [Go1-4]. Let $n_1, \dots, n_r \in \mathbb{N}$, and consider the power series

$$(5.11) \quad \text{Li}_{n_1, \dots, n_r}(z_1, \dots, z_r) = \sum_{0 < k_1 < \dots < k_r} \frac{z_1^{k_1} \dots z_r^{k_r}}{k_1^{n_1} \dots k_r^{n_r}},$$

which converges absolutely for $|z_i| \leq 1$ if $n_r \geq 2$ and for $|z_i| < 1$ in general.

Now let $\ell \geq 2$, $x_1, \dots, x_{\ell-1} \in \mathbb{C}$, and set $\Sigma = \{\sigma_0, \dots, \sigma_\ell, \infty\}$, where

$$\sigma_0 = 0, \quad \sigma_1 = 1, \quad \text{and} \quad \sigma_i = (x_{\ell-i+1} \dots x_{\ell-1})^{-1} \quad \text{for} \quad 2 \leq i \leq \ell.$$

Let $A = \{a_0, \dots, a_\ell\}$ as previously, and let $w = a_0^{n_r-1} a_{i_r} \dots a_0^{n_1-1} a_{i_1} \in \mathbb{C}\langle A \rangle$, where $1 \leq i_1, \dots, i_r \leq \ell$. We suppose that the points σ_i are distinct and finite (compare (2.5)). Let us consider the points $x_1, \dots, x_{\ell-1}$ as being fixed, and let $x_\ell \in \mathbb{P}^1 \setminus \Sigma$ denote a free variable. By (5.3), the coefficients of the corresponding hyperlogarithm function with respect to x_ℓ , are given near $x_\ell = 0$ by the formula

$$\begin{aligned} L_w(x_\ell) &= \sum_{1 \leq m_1 < \dots < m_r} \frac{(-1)^r}{m_1^{n_1} \dots m_r^{n_r}} (x_{j_1} \dots x_\ell)^{m_1} (x_{j_2} \dots x_\ell)^{m_2 - m_1} \dots (x_{j_r} \dots x_\ell)^{m_r - m_{r-1}} \\ &= (-1)^r \text{Li}_{n_1, \dots, n_r} \left(\frac{x_{j_1} \dots x_\ell}{x_{j_2} \dots x_\ell}, \dots, \frac{x_{j_{r-1}} \dots x_\ell}{x_{j_r} \dots x_\ell}, x_{j_r} \dots x_\ell \right), \end{aligned}$$

where we have set $j_k = \ell - i_k + 1$ for $1 \leq k \leq r$. It follows that such a multiple polylogarithm, considered as a function of the single variable x_ℓ , is a hyperlogarithm function on $\mathbb{P}^1 \setminus \Sigma$. The relation between the multiple polylogarithm viewed as a

hyperlogarithm in x_ℓ , and the multiple polylogarithm viewed as a function of all its variables, is given by the fibration sequence between moduli spaces $\mathfrak{M}_{0,n}$ (§6.5).

5.5. Multiple zeta values and $\mathbb{P}^1 \setminus \{0, 1, \infty\}$. In the case where $\sigma_0 = 0$ and $\sigma_1 = 1$, D is the projective line minus three points. Since $\mathbb{P}^1 \setminus \{0, 1, \infty\}$ also coincides with $\mathfrak{M}_{0,4}$, it is natural to make a change of sign and define $X = \{x_0, x_1\}$, where $x_0 = a_0$ and $x_1 = -a_1$. Let $\log z$ denote the branch of the logarithm which is real for $z \in \mathbb{R}$, $z > 0$. By proposition (5.1), the equations

$$(5.12) \quad \begin{aligned} \frac{dL(z)}{dz} &= \left(\frac{x_0}{z} + \frac{x_1}{1-z} \right) L(z) \\ L(z) &\sim \exp(x_0 \log z) \end{aligned}$$

have a unique solution $L(z) \in \mathbb{C}\langle\langle X \rangle\rangle$, known as the generating series of multiple polylogarithms in one variable. Its coefficients are written $\text{Li}_w(z)$, for $w \in X^*$. We have $\text{Li}_{x_0}(z) = \log z$ and $\text{Li}_{x_1}(z) = -\log(1-z)$. Now consider a word $w \in x_0 X^* x_1$ which begins in x_0 and ends in x_1 . It can be written

$$w = x_0^{n_r-1} x_1 x_0^{n_{r-1}-1} x_1 \dots x_0^{n_1-1} x_1 ,$$

where $n_r \geq 2$. Equation (5.3) therefore gives a power series expansion:

$$(5.13) \quad \text{Li}_w(x) = \text{Li}_{n_1, \dots, n_r}(1, \dots, 1, z) = \sum_{0 < k_1 < \dots < k_r} \frac{z^{k_r}}{k_1^{n_1} \dots k_r^{n_r}} ,$$

which is regular at $z = 1$. The numbers $\text{Li}_w(1)$ satisfy the shuffle relations by (5.5).

Definition 5.10. Let $w \in x_0 X^* x_1$ as above. The *multiple zeta value* of weight $n_1 + \dots + n_r$ and depth r is the real number defined by the convergent sum:

$$\zeta(w) = \zeta(n_1, \dots, n_r) = \text{Li}_w(1) = \sum_{0 < k_1 < \dots < k_r} \frac{1}{k_1^{n_1} \dots k_r^{n_r}} , \quad n_r \geq 2.$$

The function ζ extends by linearity to the \mathbb{Q} -vector space spanned by $x_0 X^* x_1$. We define \mathcal{Z} to be the \mathbb{Q} -module generated by the set of all multiple zeta values:

$$(5.14) \quad \mathcal{Z} = \mathbb{Q}[\zeta(w) : w \in x_0 X^* x_1] .$$

Because the multiple zeta values satisfy the shuffle relation $\zeta(w \mathfrak{m} w') = \zeta(w)\zeta(w')$, and because $\mathbb{Q}[w : w \in x_0 X^* x_1]$ is stable under the shuffle product, $\mathcal{Z} \subset \mathbb{R}$ is an algebra. It is naturally filtered by the weight [Wa].

It is not difficult to verify that every word $w \in X^*$ is a linear combination of shuffles of x_0, x_1 and words $\eta \in x_0 X^* x_1$. The map $w \mapsto \zeta(w)$ extends to a unique function on $\mathbb{Z}\langle X \rangle$ which satisfies

$$\begin{aligned} \zeta_{\mathfrak{m}}(x_0) &= 0 , & \zeta_{\mathfrak{m}}(x_1) &= 0 , \\ \zeta_{\mathfrak{m}}(w \mathfrak{m} w') &= \zeta_{\mathfrak{m}}(w)\zeta_{\mathfrak{m}}(w') , & \text{for all } w, w' \in X^* . \end{aligned}$$

Definition 5.11. The *Drinfeld associator* [Dr] is the non-commutative series

$$Z^{0,1} = \sum_{w \in X^*} \zeta_{\mathfrak{m}}(w)w \in \mathcal{Z}\langle\langle X \rangle\rangle .$$

It follows that Drinfeld's associator is precisely the regularised value of $L(z)$ at 1:

$$(5.15) \quad \text{Reg}(L(z), 1) = Z^{0,1} .$$

6. THE UNIVERSAL ALGEBRA OF POLYLOGARITHMS ON $\mathfrak{M}_{0,n}$

In this section, we give an explicit construction of the algebra of all homotopy-invariant iterated integrals on $\mathfrak{M}_{0,S}$ in terms of multiple polylogarithms. By decomposing this algebra as a tensor product of hyperlogarithm algebras, we compute its monodromy in terms of multiple zeta values.

6.1. The cohomology ring of $\mathfrak{M}_{0,S}$. Recall that $\mathfrak{M}_{0,S}$ was defined as the quotient of the configuration space of $n = |S|$ distinct points $(z_s)_{s \in S} \in (\mathbb{P}^1)^S$, modulo the action of PSL_2 . Let $i, j, k, l \in S$. The cross-ratio $[i j | k l] : (\mathbb{P}^1)_*^S \rightarrow \mathbb{P}^1$ defines a function on $(\mathbb{P}^1)_*^S$, and since $[i j | k l] = 1 - [i k | j l]$, we have:

$$(6.1) \quad d \log [i j | k l] \wedge d \log [i k | j l] = 0 .$$

We introduce the notation

$$(6.2) \quad \Delta_{ij} = d \log (z_i - z_j) = \frac{dz_i - dz_j}{z_i - z_j} , \quad \text{for all } 1 \leq i < j \leq n .$$

where $\Delta_{ij} = \Delta_{ji}$, and $\Delta_{ii} = 0$, for all $1 \leq i, j \leq n$. Equation (6.1) gives a quadratic relation between the Δ_{ij} , which can be simplified as follows. Since $\mathrm{PSL}_2(\mathbb{C})$ acts transitively on the projective line $\mathbb{P}^1(\mathbb{C})$, and since the cross-ratio is invariant under its action, we can place the point z_1 at infinity, and it follows that

$$(6.3) \quad \mathfrak{M}_{0,S}(\mathbb{C}) = \mathbb{C}_*^{n-1} / B ,$$

where \mathbb{C}_*^{n-1} denotes the set of distinct $n-1$ -tuples $z_2, \dots, z_n \in \mathbb{C}$, and $B \cong \mathbb{C}^\times \ltimes \mathbb{C}$ is the subgroup of $\mathrm{PSL}_2(\mathbb{C})$ which stabilizes ∞ . The projection map $\mathbb{C}_*^{n-1} \rightarrow \mathfrak{M}_{0,S}(\mathbb{C})$ is a trivial fibration with fibres isomorphic to B , and it follows that

$$(6.4) \quad H^*(\mathbb{C}_*^{n-1}) \cong H^*(\mathfrak{M}_{0,S}(\mathbb{C})) \otimes H^*(B) .$$

We can therefore deduce the cohomology of $\mathfrak{M}_{0,S}(\mathbb{C})$ from the structure of $H^*(\mathbb{C}_*^{n-1})$, which can be described as follows. We apply (6.1) with $l = 1$. Using the fact that $z_1 = \infty$, we deduce that $d \log [i j | k l] = \Delta_{ik} - \Delta_{jk}$, and $d \log [i k | j l] = \Delta_{ij} - \Delta_{kj}$, viewed as 1-forms on \mathbb{C}_*^{n-1} . Then (6.1) yields Arnold's relation:

$$(6.5) \quad \Delta_{ij} \wedge \Delta_{jk} + \Delta_{jk} \wedge \Delta_{ki} + \Delta_{ki} \wedge \Delta_{ij} = 0 ,$$

for any distinct indices $2 \leq i, j, k \leq n$.

Theorem 6.1. (Arnold [Ar]). *$H^*(\mathbb{C}_*^{n-1})$ is the quotient of the free exterior algebra generated by Δ_{ij} for $2 \leq i, j \leq n$, by the quadratic relations (6.5).*

Now let us fix a dihedral structure δ on S . In §2 we defined 1-forms

$$\omega_{ij} = d \log u_{ij} , \quad \text{for } \{i, j\} \in \chi_{S,\delta} .$$

Their cohomology classes $[\omega_{ij}]$ form a basis for $H^1(\mathfrak{M}_{0,S}(\mathbb{C}))$. Recall the definition of N (§3.2) as the kernel of the exterior product:

$$N = \ker \left(\wedge : H^1(\mathfrak{M}_{0,S}(\mathbb{C})) \otimes H^1(\mathfrak{M}_{0,S}(\mathbb{C})) \longrightarrow H^2(\mathfrak{M}_{0,S}(\mathbb{C})) \right) .$$

Proposition 6.2. *N is spanned by the following elements:*

$$(6.6) \quad \left(\sum_{\{i,j\} \in A} [\omega_{ij}] \right) \otimes \left(\sum_{\{k,l\} \in B} [\omega_{kl}] \right) ,$$

where $A, B \subset \chi_{S,\delta}$ are any two sets of chords which cross completely (§2.2). The cohomology ring $H^*(\mathfrak{M}_{0,S}(\mathbb{C}))$ is isomorphic to the free exterior algebra generated by $[\omega_{ij}]$, for $\{i, j\} \in \chi_{S,\delta}$, modulo the image of elements of the form (6.6).

Proof. First we regard each dihedral coordinate u_{ij} as a function on $(\mathbb{P}^1)_*$. By the defining equations (2.10), we have $1 - \prod_{a \in A} u_a = \prod_{b \in B} u_b$ for all sets of chords $A, B \subset \chi_{S, \delta}$ which cross completely. This implies that $d \log \prod_A u_a \wedge d \log \prod_B u_b = 0$, which is precisely

$$\left(\sum_{\{i,j\} \in A} [\omega_{ij}] \right) \wedge \left(\sum_{\{k,l\} \in B} [\omega_{kl}] \right) = 0 .$$

Furthermore, every instance of (6.1) occurs in this way, since each cross ratio $[ij|kl]$ can be written as a product $\prod_A u_a$ or its inverse, by lemma 2.2. We now place $z_1 = \infty$ as above, and view the corresponding relations on \mathbb{C}_*^{n-1} . By Arnold's theorem, this implies that (6.6) generates the set of all relations on \mathbb{C}_*^{n-1} . In particular, (6.6) generates N , since by (6.4), $H^*(\mathfrak{M}_{0,S}(\mathbb{C})) \subset H^*(\mathbb{C}_*^{n-1})$ and so any relation satisfied by the ω_{ij} is also satisfied in $H^*(\mathbb{C}_*^{n-1})$.

Now, since $B \cong \mathbb{C}^\times \times \mathbb{C}$ is homotopy equivalent to a circle, $H^*(B)$ is the exterior algebra generated by a single cohomology class which we denote $\beta \in H^1(B)$. It follows from (6.4) that $H^*(\mathfrak{M}_{0,S}(\mathbb{C}))$ is the subalgebra of $H^*(\mathbb{C}_*^{n-1})$ of degree 0 in β . We deduce from Arnold's theorem that $H^*(\mathfrak{M}_{0,S}(\mathbb{C}))$ is the quotient of the free exterior algebra generated by a basis of $H^1(\mathfrak{M}_{0,S}(\mathbb{C}))$, modulo N . \square

Similar results have been obtained by Getzler [Ge].

Remark 6.3. The quadratic relations (6.5) are equivalent to the existence of the dilogarithm function, in the following sense. Let $f = [ij|kl]$. Then identity (6.5) is precisely the integrability of the element

$$[d \log f | d \log(1 - f)] \in W^2 B(\mathfrak{M}_{0,S}) .$$

The iterated integral (§3.6) corresponding to this element is the function $\text{Li}_2(f)$.

6.2. The universal algebra of polylogarithms on $\mathfrak{M}_{0,S}$. Recall that in simplicial coordinates (2.3), the space $\mathfrak{M}_{0,S}$ is the open complement of an affine hyperplane arrangement. Its ring of regular functions is

$$\mathcal{O}(\mathfrak{M}_{0,S}) = \mathbb{Q}[u_{ij}, u_{ij}^{-1}] \cong \mathbb{Q} \left[(t_i)_{1 \leq i \leq \ell}, \left(\frac{1}{t_i} \right)_{1 \leq i \leq \ell'}, \frac{1}{(1 - t_i)_{1 \leq i \leq \ell}}, \frac{1}{(t_i - t_j)_{1 \leq i < j \leq \ell}} \right],$$

which is a differential algebra with respect to the partial differential operators $\partial/\partial t_i$. We defined the abstract algebra of homotopy-invariant iterated integrals on $\mathfrak{M}_{0,S}$ using the reduced bar construction in §3.2.

Definition 6.4. The *universal algebra of polylogarithms* on $\mathfrak{M}_{0,S}$ is the differential graded algebra $B(\mathfrak{M}_{0,S}) = B(\mathcal{O}(\mathfrak{M}_{0,S}))$.

Recall that $B(\mathfrak{M}_{0,S})$ is the unipotent closure of $\mathcal{O}(\mathfrak{M}_{0,S})$, and that its de Rham cohomology is trivial, *i.e.*, $H_{\text{DR}}^0(B(\mathfrak{M}_{0,S})) \cong \mathbb{Q}$, and $H_{\text{DR}}^i(B(\mathfrak{M}_{0,S})) = 0$ for all $i \geq 1$. The structure of $B(\mathfrak{M}_{0,S})$ is particularly rich: it has a natural Hopf algebra structure over $\mathcal{O}(\mathfrak{M}_{0,S})$, and also carries an action of the symmetric group $\mathfrak{S}(S)$ by functoriality. The graded pieces of the set of indecomposable elements in $B(\mathfrak{M}_{0,S})$ of fixed weight yield very interesting finite-dimensional representations of $\mathfrak{S}(S)$. Correspondingly, there is an action by the subgroup of dihedral symmetries D_{2n} of the n -gon (S, δ) . This action is evident from the symmetric description of $H^1(\mathfrak{M}_{0,S})$ and N in terms of the forms ω_{ij} , for $\{i, j\} \in \chi_{S, \delta}$, given in proposition 6.2.

Now if we pass to cubical coordinates, we can split $B(\mathfrak{M}_{0,S})$ as a tensor product of shuffle algebras, and subsequently decompose it into convergent and non-convergent

pieces. First, recall that we defined a base point at infinity (3.37), corresponding to the origin $x_1 = \dots = x_\ell = 0$, which is locally a normal crossing divisor. The base point is given by the map $\mathcal{O}(\mathfrak{M}_{0,S}) \rightarrow k\{\epsilon_1, \dots, \epsilon_\ell\}$ which maps x_i to ϵ_i , for $1 \leq i \leq \ell$. The projection map $(x_1, \dots, x_\ell) \mapsto (x_1, \dots, x_{\ell-1})$ defines a linear fibration $\mathfrak{M}_{0,\{s_1, \dots, s_n\}} \rightarrow \mathfrak{M}_{0,\{s_2, \dots, s_n\}}$, which forgets the point marked s_1 . In the notations of §2.3, it corresponds to the choice of sets $T_1 = \{s_n, s_1, s_2, s_3\}$, $T_2 = \{s_2, s_3, \dots, s_{n-1}\}$, and $T_1 \cap T_2 = \{s_2, s_3\}$. By iterating in this manner, we obtain a sequence of fibrations: $\mathfrak{M}_{0,\{s_i, \dots, s_n\}} \rightarrow \mathfrak{M}_{0,\{s_{i+1}, \dots, s_n\}}$, obtained by forgetting the marked point s_i , for $i = 1, n, n-1, \dots, 4$. By applying theorem 3.38 to these fibrations, we deduce that there is a canonical isomorphism:

$$(6.7) \quad B(\mathfrak{M}_{0,S}) \cong \bigotimes_{i=1}^{n-3} B_{\mathfrak{M}_{0,\Sigma_i}}(\mathbb{P}^1 \setminus \Sigma_i),$$

where $\Sigma_i = \{s_2, s_3, \dots, s_{n-i+1}\}$. Each algebra $B(\mathbb{P}^1 \setminus \Sigma_i)$ is a universal algebra of hyperlogarithms, and is a free shuffle algebra on $n-i-1$ generators by §5.2.

Corollary 6.5. *$B(\mathfrak{M}_{0,S})$ is isomorphic, as a $\mathcal{O}(\mathfrak{M}_{0,S})$ -algebra, to the tensor product of the free shuffle algebras on $2, 3, \dots, n-2$ generators.*

Using results of Radford, one can write down a basis of any free shuffle algebra in terms of Lyndon words (see [Rad]). The corollary implies that a basis of $B(\mathfrak{M}_{0,S})$ is given by tensor products of Lyndon words.

We can now decompose each component of (6.7) into convergent and non-convergent parts. We can define the subalgebra $B'_{\mathfrak{M}_{0,\Sigma_i}}(\mathbb{P}^1 \setminus \Sigma_i) \subset B_{\mathfrak{M}_{0,\Sigma_i}}(\mathbb{P}^1 \setminus \Sigma_i)$ of convergent words in a similar manner to (5.9). We can then define

$$B_0(\mathfrak{M}_{0,S}) = \mathcal{O}(\mathfrak{M}_{0,S}) \otimes \bigotimes_{i=1}^{n-3} B'_{\mathfrak{M}_{0,\Sigma_i}}(\mathbb{P}^1 \setminus \Sigma_i).$$

Then $B(\mathfrak{M}_{0,S})$ decomposes as a commutative tensor product

$$B(\mathfrak{M}_{0,S}) \cong B_0(\mathfrak{M}_{0,S}) \otimes_{\mathbb{Q}} \mathbb{Q}[[d \log x_1], \dots, [d \log x_\ell]].$$

The algebra on the right is the free commutative (polynomial) algebra on generators $[\omega_{2i+3}] = [d \log x_i]$ for $i = 1, \dots, \ell$.

Lemma 6.6. *The subalgebra $B_0(\mathfrak{M}_{0,S}) \subset B(\mathfrak{M}_{0,S})$ is generated as a vector space by the set of integrable words, no element of which ends in a symbol ω_{2k} , for $4 \leq k \leq n$.*

Proof. Let A denote the $\mathcal{O}(\mathfrak{M}_{0,S})$ -subalgebra of $B(\mathfrak{M}_{0,S})$ generated by the set of all integrable words

$$\sum_I c_I [\omega_{i_1 j_1} | \dots | \omega_{i_r j_r}], \quad c_I \in \mathbb{Q},$$

where $\{i_r, j_r\} \notin \{\{2, 4\}, \dots, \{2, n\}\}$. It is clear that $A \subset B_0(\mathfrak{M}_{0,S})$ is a differential subalgebra. Furthermore, one easily checks that every element $a \in \Omega^1(\mathfrak{M}_{0,S}) \otimes_{\mathcal{O}(\mathfrak{M}_{0,S})} A$ of weight at least 1 has a primitive in A . This follows from the proof of theorem 3.26 or the argument given in the appendix, since taking primitives involves adding symbols to the left of each word. Using the techniques of §3, proposition 3.12, it follows immediately that the map $A \rightarrow B_0(\mathfrak{M}_{0,S})$ is surjective. \square

Likewise, for every vertex $v \in V^\delta$, the set of vertex coordinates at v defines a base point at infinity, and (by considering the action of the differential Galois group of $U\{\epsilon_1, \dots, \epsilon_\ell\}$ over $k\{\epsilon_1, \dots, \epsilon_\ell\}$, for example), one defines a subalgebra of convergent words $B_{v,\delta}(\mathfrak{M}_{0,S})$ such that

$$B(\mathfrak{M}_{0,S}) \cong B_{v,\delta}(\mathfrak{M}_{0,S}) \otimes_{\mathbb{Q}} \mathbb{Q}[\omega_{i_1 j_1}] \otimes_{\mathbb{Q}} \dots \otimes_{\mathbb{Q}} \mathbb{Q}[\omega_{i_\ell j_\ell}] ,$$

where $\{i_1, j_1\}, \dots, \{i_\ell, j_\ell\} \in F_v$ are the chords occurring in the triangulation corresponding to v . As above, $B_{v,\delta}(\mathfrak{M}_{0,S})$ corresponds to the set of all integrable words which do not terminate in any symbol $\omega_{i_k j_k}$. The case $B_0(\mathfrak{M}_{0,S})$ corresponds to the vertex whose triangulation is $\{\{2, 4\}, \dots, \{2, n\}\}$. This is just the point $x_1 = \dots = x_\ell = 0$ in cubical coordinates.

6.3. The dihedral connection on $\mathfrak{M}_{0,S}$. There is a canonical differential equation on $\mathfrak{M}_{0,S}$ whose solutions can be expressed in terms of multiple polylogarithms. Let $\mathbb{Z}\langle \delta_{ij} \rangle$ denote the free non-commutative Hopf algebra generated by the symbols $\delta_{ij} = \delta_{ji}$, for $\{i, j\} \in \chi_{S,\delta}$, where δ_{ij} is primitive (see §3.1). It is convenient to set $\delta_{ii} = \delta_{i i+1} = 0$ for all indices $i \in \mathbb{Z}/n\mathbb{Z}$. Consider the following formal 1-form on $\mathfrak{M}_{0,S}$:

$$(6.8) \quad \Omega_{S,\delta} = \sum_{\{i,j\} \in \chi_{S,\delta}} \delta_{ij} \frac{du_{ij}}{u_{ij}} .$$

The form $\Omega_{S,\delta}$ is integrable if and only if $d\Omega_{S,\delta} = \Omega_{S,\delta} \wedge \Omega_{S,\delta}$. Since $\Omega_{S,\delta}$ is closed, this reduces to $\Omega_{S,\delta} \wedge \Omega_{S,\delta} = 0$. We define the *dihedral infinitesimal braid relations* to be the identities:

$$(6.9) \quad [\delta_{i-1 j} + \delta_{i j-1} - \delta_{i-1 j-1} - \delta_{ij}, \delta_{k-1 l} + \delta_{k l-1} - \delta_{k-1 l-1} - \delta_{kl}] = 0 ,$$

for all $i, j, k, l \in S$.

For each $1 \leq i, j \leq n$, consider a set of formal symbols t_{ij} , where $t_{ii} = 0$ and $t_{ij} = t_{ji}$. The Knizhnik-Zamolodchikov (KZ) form on $(\mathbb{P}_*^1)^n$ is the 1-form:

$$(6.10) \quad \Omega_{KZ_n} = \sum_{1 \leq i < j \leq n} t_{ij} \Delta_{ij} ,$$

where $\Delta_{ij} = \Delta_{ji}$ is given by (6.2). Let us assume that

$$(6.11) \quad \sum_{k=1}^n t_{kl} = 0 \quad \text{for all } 1 \leq l \leq n .$$

This variant of the KZ-equation has been considered by Ihara, amongst others. It corresponds to the usual KZ-equation on \mathbb{C}_*^{n-1} , except that it has an extra set of symbols at infinity, and one extra relation which kills the center of the braid algebra. One can prove that Ω_{KZ_n} is integrable if and only if the following single relation holds:

$$(6.12) \quad [t_{ij}, t_{kl}] = 0 \quad \text{for all } i, j, k, l \text{ distinct} .$$

One verifies by computing $[t_{ij}, \sum_{l=1}^n t_{kl}] = 0$, that this is equivalent to the usual infinitesimal braid relations:

$$(6.13) \quad \begin{aligned} [t_{ij}, t_{kl}] &= 0 , \\ [t_{ij}, t_{ik} + t_{jk}] &= 0 , \end{aligned}$$

which hold for all distinct indices $2 \leq i, j, k, l \leq n$. Now, by (2.6), we have $\omega_{ij} = d \log u_{ij} = \Delta_{ij+1} + \Delta_{i+1j} - \Delta_{i+1j+1} - \Delta_{ij}$, for $\{i, j\} \in \chi_{S, \delta}$. If we write

$$\Omega_{KZ_n} = \Omega_{S, \delta} ,$$

then this is equivalent to the identities

$$(6.14) \quad t_{ij} = \delta_{ij-1} + \delta_{i-1j} - \delta_{i-1j-1} - \delta_{ij} ,$$

for all $1 \leq i, j \leq n$, as is easily verified. Since $\delta_{ii} = \delta_{i+1i} = 0$ for $1 \leq i \leq n$, then (6.14) implies that

$$(6.15) \quad t_{ij} = \delta_{i-1j} \quad \text{if } j = i + 1 ,$$

$$(6.16) \quad t_{ij} = \delta_{i-1j} - \delta_{i-1j-1} - \delta_{ij} \quad \text{if } j = i + 2 .$$

The following lemma implies that the set of equations (6.14) are invertible over \mathbb{Z} .

Lemma 6.7. *For all $1 \leq i < j \leq n$,*

$$(6.17) \quad \delta_{ij} = \sum_{i < a < b \leq j} t_{ab} .$$

Proof. By equation (6.15), $\delta_{i-1i+1} = t_{ii+1}$ for $1 < i < n$. Substituting into (6.16) gives $\delta_{i-1i+2} = t_{ii+2} + t_{ii+1} + t_{i+1i+2}$. Let $m \geq 4$, and suppose by induction that (6.17) holds for all $0 < j - i \leq m - 1$. Then for $j - i = m - 1$, (6.14) gives

$$\begin{aligned} \delta_{i-1j} &= t_{ij} + \delta_{ij} + \delta_{i-1j-1} - \delta_{ij-1} , \\ &= t_{ij} + \sum_{i < a < b \leq j} t_{ab} + \sum_{i-1 < a < b \leq j-1} t_{ab} - \sum_{i < a < b \leq j-1} t_{ab} , \\ &= t_{ij} + \sum_{i < a < b \leq j} t_{ab} + \sum_{i < b \leq j-1} t_{ib} = \sum_{i-1 < a < b \leq j} t_{ab} . \end{aligned}$$

This proves (6.17) when $j - i = m$. The result follows by induction. \square

Now if we substitute the expressions (6.14) for t_{ij} and t_{kl} in terms of δ_{ab} in equation (6.12), then we obtain (6.9). This proves the following result.

Proposition 6.8. *The form $\Omega_{S, \delta}$ is integrable if and only if the dihedral braid relations (6.9) hold.*

Lemma 6.9. *The dihedral braid relations imply that*

$$(6.18) \quad [\delta_{ij}, \delta_{kl}] = 0 ,$$

for all chords $\{i, j\}, \{k, l\} \in \chi_{S, \delta}$ which do not cross.

Proof. Without loss of generality, we can assume that $1 \leq i < j < k < l \leq n$. Then, by identity (6.12),

$$[\delta_{ij}, \delta_{kl}] = \left[\sum_{i < a < b \leq j} t_{ab}, \sum_{k < c < d \leq l} t_{cd} \right] = 0 ,$$

since all sets of four indices $\{a, b, c, d\}$ occurring in the summation are distinct. \square

Example 6.10. In the case $S = \{1, 2, 3, 4, 5\}$, relation (6.9) with $i = 2, j = 4, k = 3, l = 5$ implies that $[\delta_{14} - \delta_{13} - \delta_{24}, \delta_{25} - \delta_{35} - \delta_{24}] = 0$. By (6.18) this gives the following five-term relation:

$$(6.19) \quad [\delta_{13}, \delta_{24}] + [\delta_{24}, \delta_{35}] + [\delta_{35}, \delta_{41}] + [\delta_{41}, \delta_{52}] + [\delta_{52}, \delta_{13}] = 0 .$$

This is dual to the functional equation of the dilogarithm. A similar relation in fact holds for any five consecutive indices on $\mathfrak{M}_{0,S}$.

Definition 6.11. Let R denote a commutative unitary ring, and let I denote the ideal in $R\langle \delta_{ij} : \{i, j\} \in \chi_{S,\delta} \rangle$ generated by the dihedral relations (6.9) above. The *dihedral braid algebra* over R is the free non-commutative R -algebra

$$(6.20) \quad \mathfrak{B}_{S,\delta}(R) = R\langle \delta_{ij} : \{i, j\} \in \chi_{S,\delta} \rangle / I .$$

This is a co-commutative graded Hopf algebra over R (§3.1), where $\deg \delta_{ij} = 1$. The product is the concatenation product, and the coproduct Γ is the unique coproduct with respect to which the generators δ_{ij} are primitive (I is a Hopf ideal because it is generated by commutators of primitive elements). It is the universal enveloping algebra of the free Lie algebra generated by the symbols δ_{ij} , subject to relation (6.9). As in §3.1, its completion is the R -Hopf algebra

$$(6.21) \quad \widehat{\mathfrak{B}}_{S,\delta}(R) = R\langle\langle \delta_{ij} : \{i, j\} \in \chi_{S,\delta} \rangle\rangle / \widehat{I}$$

where \widehat{I} is the closed ideal generated by I . It follows from the previous calculations that $\widehat{\mathfrak{B}}_{S,\delta}(R)$ is just the free non-commutative R -algebra generated by the symbols t_{ij} , for $1 \leq i, j \leq n$, which satisfy (6.11), modulo the relations (6.12). This is isomorphic to the ordinary infinitesimal braid algebra modulo its center. The difference here is that we have fixed a set of generators for this algebra which depend on the dihedral structure δ .

Let $\widehat{\mathfrak{M}}_{0,S}$ be a universal covering space for $\mathfrak{M}_{0,S}$, and let $p : \widehat{\mathfrak{M}}_{0,S} \rightarrow \mathfrak{M}_{0,S}$ denote the projection map. A multi-valued function on $\mathfrak{M}_{0,S}$ is defined to be a holomorphic function on $\widehat{\mathfrak{M}}_{0,S}$. Since the integrability conditions are satisfied in $\mathfrak{B}_{S,\delta}(\mathbb{C})$ we can consider the following formal differential equation on $\widehat{\mathfrak{M}}_{0,S}$:

$$(6.22) \quad dL = \Omega_{S,\delta} L .$$

A solution L takes values in $\widehat{\mathfrak{B}}_{S,\delta}(\mathbb{C})$. Its coefficients are multi-valued functions on $\mathfrak{M}_{0,S}$. We can fix a solution to (6.22) by specifying its value at a point of $\mathfrak{M}_{0,S}$, or its limiting value at an intersection of boundary divisors. It suffices to define solutions at intersections of divisors of maximal codimension. Therefore, we define

$$V^\delta = \{\alpha \in \chi_{S,\delta}^\ell\}$$

to be the set of all triangulations of the n -gon. By §2.5, each such triangulation determines a unique vertex of the associahedron $\overline{X}_{S,\delta}$. For each vertex $v \in V^\delta$, let $F_v = \{\{i, j\} \in \chi_{S,\delta} : u_{ij}(v) = 0\}$ denote the set of faces of the associahedron $\overline{X}_{S,\delta}$ which meet at v . Let $\log(u_{ij})$, for $\{i, j\} \in \chi_{S,\delta}$, denote the principal branch of the logarithm on $u_{ij} > 0$ (see §4.2).

Theorem 6.12. *Let $v \in V^\delta$. There exists a unique solution $L_{v,\delta}$ to (6.22) such that in a neighbourhood of v ,*

$$L_{v,\delta}(\underline{u}) = f_{v,\delta}(\underline{u}) \prod_{\{i,j\} \in F_v} \exp(\delta_{ij} \log(u_{ij})) ,$$

where $f_{v,\delta}(\underline{u}) \in \widehat{\mathfrak{B}}_{S,\delta}(\mathbb{C})$ extends to a holomorphic function in the neighbourhood of $v \in \mathfrak{M}_{0,S}^\delta$, and takes the value 1 at v . The function $f_{v,\delta}(\underline{u})$ extends holomorphically to an open neighbourhood of the interior of every face F meeting v .

Remark 6.13. The product $\prod_{\{i,j\} \in F_v} \exp(\delta_{ij} \log(u_{ij}))$ is well-defined, because by (6.18), the symbols δ_{ij} and δ_{kl} commute whenever $\{i, j\}$ and $\{k, l\}$ do not cross, and no two chords $\{i, j\}, \{k, l\} \in F_v$ can cross because F_v is a triangulation of the n -gon (S, δ) .

Proof. Let $\mathfrak{B}_{S,\delta}^{>0}(\mathbb{C}) \subset \mathfrak{B}_{S,\delta}(\mathbb{C})$ denote the kernel of the counit $\varepsilon : \mathfrak{B}_{S,\delta}(\mathbb{C}) \rightarrow \mathbb{C}$. For each integer $N \geq 1$, define

$$W_N = \mathfrak{B}_{S,\delta}(\mathbb{C}) / (\mathfrak{B}_{S,\delta}^{>0}(\mathbb{C}))^{N+1} .$$

If we write δ_{ij} for the map which acts by left multiplication by the symbol δ_{ij} , for each $\{i, j\} \in \chi_{S,\delta}$, then each δ_{ij} is a nilpotent operator on the space W_N .

In §4.1 we showed that $\overline{X}_{S,\delta}$ is a manifold with corners by constructing a specific atlas $\{U_\varepsilon(\varepsilon)\}$. We will show that $\Omega_{S,\delta}$ defines a unipotent equation of Fuchs' type on each chart (definition 4.7), and apply the results of §4.3. Therefore, let $\alpha \in \chi_{S,\delta}^k$ denote a partial decomposition of the n -gon, where $1 \leq k \leq \ell$. To α corresponds the face F_α of $\overline{X}_{S,\delta}$. Choose any complete triangulation $\alpha' \in \chi_{S,\delta}^\ell$ which contains α . By proposition (2.18), the vertex coordinates

$$\{x_i^{\alpha'} : 1 \leq i \leq \ell\} = \{u_{ij} : \{i, j\} \in \alpha'\}$$

form a system of normal coordinates in a neighbourhood of F_α . We can therefore write

$$\Omega_{S,\delta} = \sum_{\{i,j\} \in \alpha'} \delta_{ij} \frac{du_{ij}}{u_{ij}} + A_{ij} du_{ij} ,$$

where A_{ij} are holomorphic functions in a neighbourhood of F_α . Since the operators δ_{ij} are nilpotent on W_N , and since the open neighbourhoods of every face F_α (including $F_\emptyset = X_{S,\delta}$) cover $\overline{X}_{S,\delta}$, it follows that (6.22) is unipotent of Fuchs' type, as required.

By theorem 4.6, we can find a local solution $L_{v,\delta}^{(N)}$ to (6.22) with values in $W_N(\mathbb{C})$, which satisfies the asymptotic condition stated above. By corollary 4.8, this solution extends globally over the whole Stasheff polytope $\overline{X}_{S,\delta}$. The theorem follows on taking the limit as N tends to infinity, since $\mathfrak{B}_{S,\delta}(\mathbb{C}) = \varprojlim \mathfrak{B}_{S,\delta}(\mathbb{C}) / (\mathfrak{B}_{S,\delta}^{>0}(\mathbb{C}))^N$. \square

Any such solution $L_{v,\delta}$ to (6.22) extends by analytic continuation to give a multi-valued function on the whole of $\mathfrak{M}_{0,S}$. By construction, the theorem defines a unique real-valued branch on the interior of the associahedron $X_{S,\delta}$. It is convenient to write the asymptotic boundary condition

$$L_{v,\delta} \sim \prod_{\{i,j\} \in F_v} u_{ij}^{\delta_{ij}} \quad \text{near } v .$$

Remark 6.14. The formal equation (6.22) is a homogeneous version of the Knizhnik-Zamolodchikov equation on \mathbb{C}_*^{n-1} . Drinfeld studied solutions to the KZ equation on $\mathbb{C}_*^3, \mathbb{C}_*^4$ with prescribed asymptotics in certain zones [Dr], which were subsequently generalised by Kapranov [Ka]. Such a zone is determined by a permutation on $n-1$ letters, plus a bracketing on the set with $n-1$ letters. Combinatorially, a permutation on $n-1$ letters corresponds to a cyclic structure on n letters, and a bracketing corresponds to a triangulation of an n -gon, *i.e.*, a vertex in the associahedron of dimension $n-3$ (fig. 11). Kapranov interpreted each zone as the

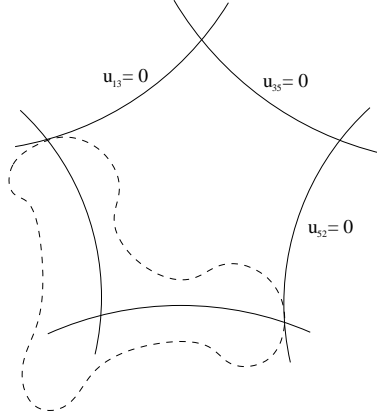

FIGURE 14. A local picture of $\overline{\mathfrak{M}}_{0,5}(\mathbb{R})$ and a cell X_{5,δ_i} . The dashed region depicts the set of real points of a domain of holomorphy for the regularised function $f_{v,\delta}$ given in theorem 6.12.

region near a corner at infinity in a certain two-fold cover \tilde{S} of the compactified real moduli space:

$$\tilde{S} \rightarrow \overline{\mathfrak{M}}_{0,S}(\mathbb{R}) .$$

In the previous theorem, we have constructed a canonical solution $L_{v,\delta}$ near each corner on $\overline{\mathfrak{M}}_{0,S}(\mathbb{R})$. Therefore, each solution $L_{v,\delta}$ corresponds to exactly two Drinfeld-Kapranov zones. One way to see this is that the manifold \tilde{S} is obtained by gluing together a set of associahedra which are parametrized by the set of all cyclic, rather than dihedral structures. The number of cyclic structures on S , where $|S| = n$ is exactly $(n-1)!$. As an example, let us consider the simplest case $\mathfrak{M}_{0,4}$. Then equation (6.22) reads:

$$(6.23) \quad \frac{dL}{dx} = \left(\frac{\delta_{13}}{x} + \frac{\delta_{24}}{x-1} \right) L ,$$

Consider the solution $L_{0^+}(x)$ which satisfies $L_{0^+}(x) \sim \exp(\delta_{13} \log x)$ as $x \rightarrow 0^+$. Remembering that $x = u_{13} = [12|43]$, and after placing the point z_4 at ∞ , we obtain $x = (z_2 - z_3)/(z_1 - z_3)$. If $0 < x < 1$, then either $z_1 < z_2 < z_3$ or $z_3 < z_2 < z_1$. These are the two cyclic structures on $\{z_1, z_2, z_3, \infty\}$ which map to the dihedral structure δ corresponding to the cell $[0, 1] = \overline{X}_{S,\delta}$. The zone $0 < x \ll 1$ therefore corresponds to the pair of zones $z_1(z_2z_3)$ and $(z_3z_2)z_1$ in Kapranov's notations.

6.4. Functoriality with respect to projection maps. It is well-known that solutions to the KZ-equation decompose as products of hyperlogarithm equations by considering fibration maps between configuration spaces. One obtains a more general decomposition result for the homogeneous equation (6.22), by using the projection maps considered in §2.3. First, we fix a dihedral structure δ on S and choose a chord $\{i, j\} \in \chi_{S,\delta}$. Recall from §2.3, that if we set $T_1 = \{s_{j+1}, \dots, s_i, s_{i+1}\}$, and $T_2 = \{s_i, s_{i+1}, \dots, s_j\}$, and denote the induced dihedral structures by δ_1, δ_2 , then $T_1 \cap T_2 = \{s_i, s_{i+1}\}$, and there is a projection map:

$$f_{T_1} \times f_{T_2} : \mathfrak{M}_{0,S}^\delta \longrightarrow \mathfrak{M}_{0,T_1}^{\delta_1} \times \mathfrak{M}_{0,T_2}^{\delta_2} .$$

By lemma 2.6, this map has a section whose image is the divisor $D_{ij} = \{u_{ij} = 0\}$:

$$i : \mathfrak{M}_{0,T_1}^{\delta_1} \times \mathfrak{M}_{0,T_2}^{\delta_2} \xrightarrow{\sim} D_{ij} \subset \mathfrak{M}_{0,S}^\delta .$$

In order to fix solutions of (6.22), let $v \in V^\delta$ be a vertex of the polytope $\overline{X}_{S,\delta}$ such that $v \in D_{ij}$, *i.e.*, $u_{ij}(v) = 0$. By projecting down, we obtain vertices in $\overline{X}_{T_k,\delta_k}$:

$$v_k = f_{T_k}(v) \in \overline{X}_{T_k,\delta_k} \quad \text{for } k = 1, 2 .$$

If v is given by a triangulation $\alpha \in \chi_{S,\delta}^\ell$ of the n -gon S , then v_1, v_2 are given by the restrictions α_1, α_2 of this triangulation to T_1 and T_2 respectively (compare fig. 4). As sets of chords, we have $\alpha = \alpha_1 \sqcup \alpha_2 \sqcup \{i, j\}$. We need an extra technical condition that the only chord in α emanating from the vertex (j) is the chord $\{i, j\}$ (the dihedral coordinate corresponding to such a chord would not be preserved since f_{T_1} and f_{T_2} contract one of the edges j or $j+1$). Let

$$i_{T_1} : \mathfrak{M}_{0,T_1}^{\delta_1} \longrightarrow \mathfrak{M}_{0,T_1}^{\delta_1} \times \mathfrak{M}_{0,T_2}^{\delta_2} \longrightarrow D_{ij}$$

denote the map which sends x to $i(x, v_2) \in D_{ij}$. Define a map i_{T_2} similarly, and set

$$(6.24) \quad \pi_k = i_{T_k} \circ f_{T_k} \quad \text{for } k = 1, 2 .$$

Then π_k is a projection map

$$\pi_k : \mathfrak{M}_{0,S}^\delta \rightarrow D_{\alpha_k \sqcup \{i,j\}} \quad \text{for } k = 1, 2 ,$$

because $f_{T_k} \circ i_{T_k}$ is the identity. We can write these maps explicitly in vertex coordinates $x_1^\alpha, \dots, x_\ell^\alpha$, which form a local system of coordinates on $\mathfrak{M}_{0,S}^\delta(\mathbb{C})$ (see §2.4). We can choose an ordering on α such that $D_{\alpha_2} = \{x_1^\alpha = \dots = x_{m-1}^\alpha = 0\}$, $u_{ij} = x_m^\alpha$, and $D_{\alpha_1} = \{x_{m+1}^\alpha = \dots = x_\ell^\alpha = 0\}$ for some m . In that case, we have

$$f_{T_1} \times f_{T_2} : (x_1^\alpha, \dots, x_\ell^\alpha) \longrightarrow ((x_1^\alpha, \dots, x_{m-1}^\alpha), (x_{m+1}^\alpha, \dots, x_\ell^\alpha)) ,$$

and

$$\begin{aligned} \pi_1 : (x_1^\alpha, \dots, x_\ell^\alpha) &\mapsto (x_1^\alpha, \dots, x_{m-1}^\alpha, 0, \dots, 0) \\ \pi_2 : (x_1^\alpha, \dots, x_\ell^\alpha) &\mapsto (0, \dots, 0, x_{m+1}^\alpha, \dots, x_\ell^\alpha) . \end{aligned}$$

We shall write $\partial/\partial u_{ij}$ to denote partial differentiation with respect to the vertex coordinate $x_m^\alpha = u_{ij}$ in a neighbourhood of $v \in \mathfrak{M}_{0,S}^\delta(\mathbb{C})$.

Let $L_{v,\delta}$ denote the unique solution to (6.22) on $\mathfrak{M}_{0,S}$ given by theorem 6.12. We define

$$L_k = L \circ \pi_k , \quad \text{for } k = 1, 2 .$$

Then the functions $L_k : \widehat{\mathfrak{M}}_{0,S} \rightarrow \widehat{\mathfrak{B}}_{S,\delta}(\mathbb{C})$ satisfy the differential equation

$$(6.25) \quad dL_k = \Omega_k L_k , \quad \text{for } k = 1, 2 ,$$

where Ω_k is given by:

$$\Omega_k = (\pi_k)_* \Omega_{S,\delta} = \sum_{\{a,b\} \in \chi_{T_k,\delta_k}} \delta_{ab} \frac{du_{ab}}{u_{ab}} , \quad \text{for } k = 1, 2 .$$

By construction, the solutions L_k satisfy the asymptotic condition

$$(6.26) \quad L_k = f_k \left(\sum_{\{a,b\} \in \alpha_k} \delta_{ab} \log u_{ab} \right) , \quad \text{for } k = 1, 2 ,$$

where f_k is holomorphic in a neighbourhood of v_k on D_{α_k} , where it takes the value 1. It is clear that Ω_k and L_k only involve the symbols δ_{ab} where $\{a, b\} \in \chi_{T_k,\delta_k}$. Since no chord in χ_{T_1,δ_1} crosses any chord in χ_{T_2,δ_2} , it follows from (6.18) that

L_1 and L_2 commute. Likewise, we have $[L_1, \Omega_2] = [L_2, \Omega_1] = [\Omega_1, \Omega_2] = 0$. The three series $L_{v,\delta}, L_1, L_2$ are all formal power series in $\widehat{B}_{S,\delta}(\mathbb{C})$ whose coefficients are multi-valued functions on $\mathfrak{M}_{0,S}$. They are related as follows.

Proposition 6.15. *Let $\{i, j\} \in \chi_{S,\delta}$ be any chord, and let $v \in V^\delta$ such that $u_{ij}(v) = 0$. With the notations above, there is a decomposition*

$$(6.27) \quad L_{v,\delta} = h L_1 L_2 ,$$

where h is the unique solution in $\widehat{B}_{S,\delta}(\mathbb{C})$ to the hyperlogarithm quotient equation

$$(6.28) \quad \frac{\partial h}{\partial u_{ij}} = \left(\sum_{\{k,l\} \in \chi_{S,\delta}} \delta_{kl} \frac{\partial \log u_{kl}}{\partial u_{ij}} \right) h ,$$

which satisfies the boundary condition

$$(6.29) \quad h = g \exp(\delta_{ij} \log u_{ij}) ,$$

where g is a holomorphic function of u_{ij} in a neighbourhood of 0, and $g|_{u_{ij}=0}$ is the constant function 1.

Proof. Define a formal power series $h \in \widehat{B}_{S,\delta}(\mathbb{C})$ by the equation $h = L_{v,\delta} L_2^{-1} L_1^{-1}$. If we differentiate this equation, we deduce that

$$\Omega_{S,\delta} L_{v,\delta} = dh L_1 L_2 + h \Omega_1 L_1 L_2 + h \Omega_2 L_1 L_2 ,$$

where we have used the fact that $[\Omega_2, L_1] = 0$. It follows that

$$(6.30) \quad dh = \Omega_{S,\delta} h - h (\Omega_1 + \Omega_2) .$$

By definition, the functions L_k do not depend on the variable u_{ij} , i.e., $\partial L_k / \partial u_{ij} = 0$, for $k = 1, 2$. Therefore $\partial h / \partial u_{ij} = \partial L_{v,\delta} / \partial u_{ij} L_2^{-1} L_1^{-1}$, and (6.22) implies that

$$\frac{\partial h}{\partial u_{ij}} = \left(\sum_{\{k,l\} \in \chi_{S,\delta}} \frac{\delta_{kl}}{u_{kl}} \frac{\partial u_{kl}}{\partial u_{ij}} \right) h .$$

By definition of the solution $L_{v,\delta}$ and equations (6.26), we have

$$h = f_{v,\delta} \exp \left(\sum_{\{a,b\} \in \alpha} \delta_{ab} \log u_{ab} \right) \exp \left(- \sum_{\{a,b\} \in \alpha_2} \delta_{ab} \log u_{ab} \right) f_2^{-1} \exp \left(- \sum_{\{a,b\} \in \alpha_1} \delta_{ab} \log u_{ab} \right) f_1^{-1} ,$$

where $f_{v,\delta}$ is holomorphic in a neighbourhood of v , and $\alpha_1, \alpha_2, \alpha$ are the triangulations of T_1, T_2, S corresponding to v_1, v_2, v respectively. Since L_1 and L_2 commute,

$$h = f_{v,\delta} \exp(\delta_{ij} \log u_{ij}) f_2^{-1} f_1^{-1} = f_{v,\delta} f_2^{-1} f_1^{-1} \exp(\delta_{ij} \log u_{ij}) .$$

Let $g = f_{v,\delta} f_2^{-1} f_1^{-1} = f_{v,\delta} f_1^{-1} f_2^{-1}$, which is holomorphic in the neighbourhood of v . In order to complete the proof, it suffices to show that the function $g|_{u_{ij}=0}$ is the constant function 1. This, along with the differential equation for h , will determine h uniquely. Let G denote the restriction of g to the divisor $D_{ij} = \{u_{ij} = 0\}$. We already know by construction that $G(v) = 1$. Since g is holomorphic in the neighbourhood of $u_{ij} = 0$, G satisfies a differential equation which is obtained by projecting (6.30) onto $u_{ij} = 0$, which amounts to pulling back $\Omega_{S,\delta}$ by $(\pi_1 \times \pi_2)_*$. By definition,

$$\Omega_{S,\delta} \Big|_{D_{ij}} = \Omega_1 + \Omega_2 .$$

Equation (6.30) therefore restricts to give the following differential equation for G :

$$(6.31) \quad dG = [\Omega_1 + \Omega_2, G] ,$$

where $G(v) = 1$. This equation only has constant solutions. To see this, consider the conjugate $H = (L_1 L_2)^{-1} G L_1 L_2$. Substituting into (6.31) gives $dH = 0$. Therefore H is the constant function 1, and so the same is true of G , which completes the proof. \square

One can verify from the definitions that the map f_{T_k} induces a map

$$(f_{T_k})_* : \mathfrak{B}_{S,\delta}(\mathbb{C}) \longrightarrow \mathfrak{B}_{T_k,\delta_k}(\mathbb{C}), \quad \text{for } k = 1, 2,$$

which sends δ_{ab} to zero for all chords $\{a, b\}$ which are not in χ_{T_k,δ_k} , and is the identity on δ_{ab} for all chords $\{a, b\} \in \chi_{T_k,\delta_k}$. This also follows immediately from the fact that $\Omega_k = (\pi_k)_* \Omega_{S,\delta}$ is integrable. We can then consider

$$(f_{T_k})_* L_k : \mathfrak{M}_{0,T_k} \longrightarrow \widehat{\mathfrak{B}}_{T_k,\delta_k}(\mathbb{C}) \quad \text{for } k = 1, 2.$$

By (6.26) and the uniqueness part of theorem 6.12, we conclude that

$$L_{v_k,\delta_k} = (f_{T_k})_* L_k \quad \text{for } k = 1, 2.$$

In conclusion, a solution $L_{v,\delta}$ to (6.22) on $\mathfrak{M}_{0,S}$ is equivalent to a pair of solutions L_{v_k,δ_k} on \mathfrak{M}_{0,T_k} for $k = 1, 2$ plus a solution to the hyperlogarithm quotient equation (6.28). Note that many of the terms in the differential equation (6.28) vanish.

Example 6.16. Consider the case $\mathfrak{M}_{0,6}$, and let $\{i, j\} = \{2, 5\}$ (see fig. 3). Then $T_1 = \{2, 3, 4, 5\}$ and $T_2 = \{6, 1, 2, 3\}$. We shall work in cubical coordinates, and write $(x_1, x_2, x_3) = (x, y, z)$. Then $u_{24} = x$, $u_{25} = y$, and $u_{26} = z$. The map $\mathfrak{M}_{0,6} \rightarrow D_{25} \cong \mathfrak{M}_{0,T_1} \times \mathfrak{M}_{0,T_2}$ is given by projecting onto the divisor $y = 0$. Therefore $L_1(x, y, z) = L(x, 0, 0)$, and $L_2(x, y, z) = L(0, 0, z)$ and we have:

$$\begin{aligned} dL_1 &= \left(\delta_{24} \frac{dx}{x} + \delta_{35} \frac{dx}{x-1} \right) L_1, \\ dL_2 &= \left(\delta_{26} \frac{dz}{z} + \delta_{15} \frac{dz}{z-1} \right) L_2. \end{aligned}$$

Thus L_1, L_2 are generating series of multiple polylogarithms in one variable (but note that there is a difference in sign in [Br1]). On the other hand, h is the unique solution to

$$(6.32) \quad \begin{aligned} \frac{\partial h}{\partial y} &= \left(\frac{\delta_{25}}{y} + \frac{t_{56}}{y-1} + \frac{t_{46}}{y-x^{-1}} + \frac{t_{15}}{y-z^{-1}} + \frac{t_{14}}{y-(xz)^{-1}} \right) h, \\ h &\sim \exp(\delta_{25} \log y) \quad \text{as } y \rightarrow 0, \end{aligned}$$

where, according to (6.14), $t_{56} = \delta_{46}$, $t_{15} = \delta_{14} - \delta_{15} - \delta_{46}$, $t_{46} = \delta_{36} - \delta_{46} - \delta_{35}$, and $t_{14} = \delta_{13} + \delta_{46} - \delta_{14} - \delta_{36}$. By (6.13), there are commutation relations

$$[t_{14}, t_{56}] = 0, \quad \text{and} \quad [t_{15}, t_{46}] = 0.$$

Therefore (6.32) is a hyperlogarithm quotient equation on the punctured affine line $\mathbb{P}^1 \setminus \{0, 1, \infty, x^{-1}, z^{-1}, (xz)^{-1}\}$. Compare remark 2.11.

By applying the proposition repeatedly, we obtain an explicit decomposition of the generating series $L_{v,\delta}$ as products of hyperlogarithms. Let us apply the proposition in the case where $\{i, j\} = \{2, n\}$. In cubical coordinates, $u_{2n} = x_\ell$, and one can check that h is the unique function satisfying

$$(6.33) \quad \begin{aligned} \frac{\partial h}{\partial x_\ell} &= \left(\frac{\delta_{2n}}{x_\ell} + \frac{\delta_{1n-1}}{x_\ell-1} + \sum_{i=1}^{\ell-1} \frac{\delta_{i+3n} + \delta_{i+21} - \delta_{i+2n} - \delta_{i+31}}{x_\ell - (x_i \dots x_{\ell-1})^{-1}} \right) h, \\ h &\sim \exp(\delta_{2n} \log x_\ell) \quad \text{as } x_\ell \rightarrow 0. \end{aligned}$$

where, as usual, $\delta_{ii} = \delta_{i-1i} = 0$ by convention. The function $\log x$ is the unique branch satisfying $\log 1 = 0$. This defines a multi-valued function on $\mathbb{P}^1 \setminus \Sigma$ where $\Sigma = \{\sigma_0, \dots, \sigma_\ell\}$, with

$$\sigma_0 = 0, \quad \sigma_1 = 1, \quad \sigma_2 = x_{\ell-1}^{-1}, \quad \dots, \quad \sigma_{\ell-1} = (x_1 \dots x_{\ell-1})^{-1}.$$

The series $h \exp(-\delta_{2n} \log x_\ell)$ is holomorphic in the neighbourhood of $x_\ell = 0$. In this case, the projection map $f_{T_1} \times f_{T_2}$ is a fibration. It follows that h is a hyperlogarithm equation (*i.e.*, there are no relations between the coefficients in (6.33)). Notice also that the coefficient $\delta_{i+3n} + \delta_{i+2n} - \delta_{i+2n} - \delta_{i+3n}$ is just t_{1i+3} .

By substituting the above values of σ_i into the formula (5.3), we deduce that the coefficients of the formal power series h are the multiple polylogarithms (§5.4):

$$(6.34) \quad \text{Li}_{n_1, \dots, n_r} \left(\frac{x_{j_1} \dots x_\ell}{x_{j_2} \dots x_\ell}, \dots, \frac{x_{j_{r-1}} \dots x_\ell}{x_{j_r} \dots x_\ell}, x_{j_r} \dots x_\ell \right),$$

where $1 \leq j_1, \dots, j_r \leq \ell$ are any indices. By applying the proposition inductively, we obtain an explicit decomposition of $L_{v,\delta}$ in terms of hyperlogarithm generating series h .

Corollary 6.17. *$L_{v,\delta}$ is a product of hyperlogarithm generating series. Its coefficients are sums of products of multiple polylogarithms of the form (6.34) with the functions $\log x_1, \dots, \log x_\ell$.*

6.5. Regularised zeta series and monodromy. The monodromy of the KZ equation was first computed by Drinfeld [Dr]. We shall follow the argument given in [H-P-V] for $\mathfrak{M}_{0,4} \cong \mathbb{P}^1 \setminus \{0, 1, \infty\}$ (see also [GL]). Consider two vertices $u, v \in V^\delta$. By theorem 6.12, each vertex defines a generating series of multi-valued functions $L_{u,\delta}, L_{v,\delta}$ on $\mathfrak{M}_{0,S}$. The ratio of any two solutions to (6.22) is a constant series.

Definition 6.18. The *regularised zeta series* corresponding to $u, v \in V^\delta$ is

$$Z^{u,v} = (L_{u,\delta}(x))^{-1} L_{v,\delta}(x) \in \widehat{\mathfrak{B}}_{S,\delta}(\mathbb{C}),$$

for any $x \in X_{S,\delta}$, *i.e.*, $x = (u_{ij})$, where $0 < u_{ij} < 1$.

Since $L_{v,\delta}$ is real-valued on $X_{S,\delta}$, $Z^{u,v} \in \widehat{\mathfrak{B}}_{S,\delta}(\mathbb{R})$ has real coefficients. Clearly

$$(6.35) \quad Z^{u,v} Z^{v,w} = Z^{u,w}$$

for all $u, v, w \in V^\delta$, and in particular, $Z^{u,v} Z^{v,u} = 1$. The zeta series describe the limiting behaviour of a solution of (6.22) near the boundary of $\overline{X}_{S,\delta}$.

Lemma 6.19. *For all $u, v \in V^\delta$,*

$$Z^{u,v} = \lim_{x \rightarrow u} \prod_{\{i,j\} \in F_u} \exp(-\delta_{ij} \log u_{ij}) L_{v,\delta}(x),$$

where $x = (u_{ij}) \in X_{S,\delta}$.

Proof. Let $x = (u_{ij})$ and let $x \rightarrow u$ along a path in $\overline{X}_{S,\delta}$. By theorem 6.12,

$$(6.36) \quad L_{v,\delta}(x) = L_{u,\delta}(x) Z^{u,v} = f_{u,\delta} \left(\prod_{\{i,j\} \in F_u} \exp(\delta_{ij} \log u_{ij}) \right) Z^{u,v},$$

which implies that

$$Z^{u,v} = \lim_{x \rightarrow u} \left(\prod_{\{i,j\} \in F_u} \exp(-\delta_{ij} \log u_{ij}) \right) f_{u,\delta}^{-1} L_{v,\delta}(x).$$

But $f_{u,\delta}^{-1}$ is a non-commutative series which is holomorphic in a neighbourhood of u where it takes the value 1. We can write $f_{u,\delta}^{-1} = 1 + g(x)$, where g is holomorphic and vanishes at $x = u$. Since $z \log^n z \rightarrow 0$ as $z \rightarrow 0$ for all $n \in \mathbb{N}$, and since $L_{v,\delta}(x)$ has at most logarithmic singularities at $x = u$, we deduce that only the constant term 1 in $f_{u,\delta}^{-1}$ gives a non-zero contribution in the limit, which proves the result. \square

Theorem 6.20. *The coefficients of the series $Z^{u,v}$ are multiple zeta values:*

$$Z^{u,v} \in \mathcal{Z} \langle \langle \delta_{ij} : \{i, j\} \in \chi_{S,\delta} \rangle \rangle / I \quad \text{for all } u, v \in V^\delta,$$

where I denotes the closed ideal generated by the dihedral braid relations (6.9).

Proof. By the relations (6.35), it suffices to compute the coefficients of $Z^{u,v}$, where u, v are adjacent corners of $\overline{X}_{S,\delta}$. In other words, u, v are given by triangulations $\alpha, \beta \in \chi_{S,\delta}^\ell$ which differ by one chord only. Let us write $\{a, a'\} = \alpha \setminus \alpha \cap \beta$ and $\{b, b'\} = \beta \setminus \alpha \cap \beta$. Since $D_{\alpha \cap \beta}$ is of dimension 1, there is an isomorphism

$$i_{uv} : \mathfrak{M}_{0,T}^{\delta'} \xrightarrow{\sim} D_{\alpha \cap \beta} \subset \mathfrak{M}_{0,S}^\delta,$$

where $|T| = 4$, which maps the cell $\overline{X}_{T,\delta'}$ onto the 1-dimensional face of $\overline{X}_{S,\delta}$ which connects u and v . Consider the solution $L_{u,\delta}$ to (6.22) given by theorem 6.12. We can identify $\mathfrak{M}_{0,T}$ with $\mathbb{P}^1 \setminus \{0, 1, \infty\}$ and $X_{T,\delta'}$ with the interval $(0, 1)$ in such a way that $i_{uv}(0) = u$ and $i_{uv}(1) = v$. The pull-back $F = (i_{uv})_* L_{u,\delta}$ then satisfies the differential equation:

$$(6.37) \quad \begin{aligned} \frac{dF}{dx} &= \left(\frac{\delta_u}{x} + \frac{\delta_v}{x-1} \right) F, \\ F &\sim \exp(\delta_u \log x) \quad \text{as } x \rightarrow 0, \end{aligned}$$

on $\mathbb{P}^1 \setminus \{0, 1, \infty\}$. This follows from proposition 6.15. Here, δ_u, δ_v are the dihedral symbols corresponding to the chords $\{a, a'\}$, and $\{b, b'\}$. We have

$$(6.38) \quad Z^{u,v} = \text{Reg}(L_{u,\delta}, v) = \text{Reg}(F, 1) = Z^{0,1}(\delta_u, \delta_v).$$

It follows from the calculations in §5.5 that the coefficients of $Z^{u,v}$ lie in \mathcal{Z} . \square

As an example, consider the case $\mathfrak{M}_{0,5}$. Then $X_{5,\delta}$ is a pentagon with vertices v_1, v_2, \dots, v_5 in order. It follows from (6.35) that $Z^{v_1 v_2} Z^{v_2 v_3} Z^{v_3 v_4} Z^{v_4 v_5} Z^{v_5 v_1} = 1$. Applying (6.38), we deduce the pentagonal relation due to Drinfeld [Dr]:

$$Z^{0,1}(\delta_{25}, \delta_{14}) Z^{0,1}(\delta_{24}, \delta_{13}) Z^{0,1}(\delta_{14}, \delta_{35}) Z^{0,1}(\delta_{13}, \delta_{25}) Z^{0,1}(\delta_{35}, \delta_{24}) = 1 \in \widehat{\mathfrak{B}}_{5,\delta}(\mathcal{Z}).$$

Remark 6.21. One can prove the previous theorem directly using corollary 6.17. In cubical coordinates, the coefficients of $L_{v,\delta}$ are sums of products of logarithms with the multiple polylogarithms $\text{Li}_{n_1, \dots, n_r} \left(\frac{x_{j_1 \dots j_\ell}}{x_{j_2 \dots j_\ell}}, \dots, \frac{x_{j_{r-1} \dots j_\ell}}{x_{j_r \dots j_\ell}}, x_{j_r} \dots x_\ell \right)$. By taking suitable limits in such coordinate systems, one can see directly that the coefficients of each regularised zeta series are multiple zeta values.

We can compute the monodromy of a solution $L_{v,\delta}(x)$ to (6.22) explicitly in terms of the zeta series defined above. First, let us define

$$(6.39) \quad \pi_1^\delta(\mathfrak{M}_{0,S}) = \pi_1(\mathfrak{M}_{0,S}, X_{S,\delta})$$

to be the fundamental group of $\mathfrak{M}_{0,S}$ relative to the set $X_{S,\delta}$, which can be taken as a base point because it is contractible. For each $\{i, j\} \in \chi_{S,\delta}$, let

$$\gamma_{ij} \in \pi_1^\delta(\mathfrak{M}_{0,S})$$

denote a small path which winds once around the face $D_{ij} = \{u_{ij} = 0\}$ in the positive direction, *i.e.*, such that

$$\int_{\gamma_{ij}} \frac{du_{ij}}{u_{ij}} = +2\pi i .$$

For each $\{i, j\} \in \chi_{S, \delta}$, let \mathcal{M}_{ij} denote the monodromy operator given by analytic continuation of functions along a loop which is homotopy equivalent to γ_{ij} . The operators \mathcal{M}_{ij} commute with multiplication and differentiation. It follows that the \mathcal{M}_{ij} , for $\{i, j\} \in \chi_{S, \delta}$, act on $L_{v, \delta}(x)$ by right multiplication by constant series.

Proposition 6.22. *Let $\{i, j\} \in \chi_{S, \delta}$, and let $v \in V^\delta$ denote any vertex of $\overline{X}_{S, \delta}$. Choose any vertex $w \in V^\delta$ which lies on the face D_{ij} , *i.e.*, $u_{ij}(w) = 0$. Then for all $x \in X_{S, \delta}$,*

$$\mathcal{M}_{ij} L_{v, \delta}(x) = L_{v, \delta}(x) Z^{v, w} e^{2i\pi\delta_{ij}} Z^{w, v} .$$

Proof. By theorem 6.12,

$$L_{w, \delta}(x) = f_w(x) \prod_{\{k, l\} \in F_w} \exp(\delta_{kl} \log u_{kl}) ,$$

where $f_w(x)$ is holomorphic in a neighbourhood of $w \in \mathfrak{M}_{0, S}^\delta(\mathbb{C})$ which contains the interior of the face D_{ij} . By analytic continuation along a small loop γ_{ij} which is contained in this neighbourhood and winds once around D_{ij} , we deduce that

$$\mathcal{M}_{ij} L_{w, \delta}(x) = L_{w, \delta}(x) \exp(2i\pi\delta_{ij}) .$$

It follows from the definition of the zeta series that $L_{v, \delta}(x) = L_{w, \delta}(x) Z^{w, v}$ for all $x \in X_{S, \delta}$. Since the quotient $(L_{v, \delta}(x))^{-1} L_{w, \delta}(x) Z^{w, v}$ is the constant function 1, which is single-valued, the same equation must also hold for all x in the universal covering space of $\mathfrak{M}_{0, S}(\mathbb{C})$. Therefore,

$$\mathcal{M}_{ij} L_{v, \delta}(x) = \mathcal{M}_{ij} L_{w, \delta}(x) Z^{w, v} = L_{w, \delta}(x) e^{2i\pi\delta_{ij}} Z^{w, v} = L_{v, \delta}(x) Z^{v, w} e^{2i\pi\delta_{ij}} Z^{w, v} .$$

□

The previous lemma holds for any pair of vertices $w, w' \in V^\delta$ which meet D_{ij} . We immediately deduce that the following identity holds in $\widehat{\mathfrak{B}}_{S, \delta}(\mathbb{C})$:

$$(6.40) \quad Z^{v, w} e^{2i\pi\delta_{ij}} Z^{w, v} = Z^{v, w'} e^{2i\pi\delta_{ij}} Z^{w', v} .$$

This identity in fact follows from the commutation relation (6.18). It follows from the previous theorem that the monodromy of $\mathfrak{M}_{0, S}$ can be completely expressed in terms of multiple zeta values, and the constant $2\pi i$.

Corollary 6.23. *The monodromy ring of $\mathfrak{M}_{0, S}$ is $\mathcal{Z}[2\pi i]$.*

6.6. Regularisation of polylogarithms on $\mathfrak{M}_{0, S}$.

Definition 6.24. For any $v \in V^\delta$, let $L^{v, \delta}(\mathfrak{M}_{0, S})$ denote the $\mathcal{O}(\mathfrak{M}_{0, S})$ -module generated by the coefficients of the solution $L_{v, \delta}$ to (6.22) given by theorem 6.12. Now let us define

$$(6.41) \quad L_{\mathcal{Z}}^\delta(\mathfrak{M}_{0, S}) = L^{v, \delta}(\mathfrak{M}_{0, S}) \otimes_{\mathbb{Q}} \mathcal{Z} .$$

It does not depend, up to isomorphism, on the choice of the vertex v by lemma 6.19 and theorem 6.20. We write $\Omega^k L^{v, \delta}(\mathfrak{M}_{0, S}) = L^{v, \delta}(\mathfrak{M}_{0, S}) \otimes_{\mathcal{O}(\mathfrak{M}_{0, S})} \Omega^k(\mathfrak{M}_{0, S})$ and $\Omega^k L_{\mathcal{Z}}^\delta(\mathfrak{M}_{0, S}) = \Omega^k L^{v, \delta}(\mathfrak{M}_{0, S}) \otimes_{\mathbb{Q}} \mathcal{Z}$, for $k \geq 0$.

Since \mathcal{Z} is filtered by the weight, we deduce a natural weight filtration on $L_{\mathcal{Z}}^{\delta}(\mathfrak{M}_{0,S})$ which we denote by W^{\cdot} . It follows immediately that any dihedral symmetry $\sigma \in D_{2n}$ of the n -gon (S, δ) induces an isomorphism of filtered algebras

$$(6.42) \quad \sigma_* : L_{\mathcal{Z}}^{\delta}(\mathfrak{M}_{0,S}) \xrightarrow{\sim} L_{\mathcal{Z}}^{\delta}(\mathfrak{M}_{0,S}) .$$

Each algebra $L^{v,\delta}(\mathfrak{M}_{0,S})$ is in fact a graded Hopf algebra (§6.7), although we lose the grading when we pass to $L_{\mathcal{Z}}^{\delta}(\mathfrak{M}_{0,S})$, because it is not yet known whether \mathcal{Z} is graded by the weight. The following theorem shows that the function theory of multiple polylogarithms is dictated by the geometry of the Stasheff polytopes $\overline{X}_{S,\delta}$.

Theorem 6.25. *Let $\{i, j\} \in \chi_{S,\delta}$. For any function $f \in L_{\mathcal{Z}}^{\delta}(\mathfrak{M}_{0,S})$, let $\text{Reg}(f, D_{ij})$ denote the regularised restriction of f to the divisor D_{ij} , which maps not only logarithmic, but also polar singularities to zero. As in lemma 2.6, let $T_1 \cup T_2 = S$ denote the partition corresponding to the chord $e = \{i, j\}$, such that*

$$D_{ij} \cong \overline{\mathfrak{M}}_{0,T_1 \cup e}^{\delta_1} \times \overline{\mathfrak{M}}_{0,T_2 \cup e}^{\delta_2} .$$

Then there is an isomorphism of filtered algebras:

$$\text{Reg}(L_{\mathcal{Z}}^{\delta}(\mathfrak{M}_{0,S}), D_{ij}) \cong L_{\mathcal{Z}}^{\delta_1}(\mathfrak{M}_{0,T_1}) \otimes_{\mathcal{Z}} L_{\mathcal{Z}}^{\delta_2}(\mathfrak{M}_{0,T_2}) .$$

Proof. Let us choose any vertex $v \in V^{\delta}$ such that $u_{ij}(v) = 0$. The algebra $L^{v,\delta}(\mathfrak{M}_{0,S}) \otimes_{\mathbb{Q}} \mathcal{Z}$ is generated by the coefficients of the generating series $L_{v,\delta}(x)$ over \mathcal{Z} . By proposition 6.15, there is a decomposition

$$L_{v,\delta} = h L_1 L_2 ,$$

where L_1, L_2 can be viewed as solutions of (6.22) on \mathfrak{M}_{0,T_1} and \mathfrak{M}_{0,T_2} respectively, and do not depend on u_{ij} . Since the series $h \exp(-\delta_{ij} \log u_{ij})$ is holomorphic in u_{ij} and is the constant function 1 along $D_{ij} = \{u_{ij} = 0\}$, we have $\text{Reg}(h, D_{ij}) = 1$. Therefore

$$\text{Reg}(L_{v,\delta}, D_{ij}) = L_1 L_2 .$$

Likewise, for any coefficient f of $L_{v,\delta}$, and any $k \in \mathbb{Z}$,

$$\text{Reg}\left(\frac{f}{u_{ij}^k}, D_{ij}\right) \in L^{v_1, \delta_1}(\mathfrak{M}_{0,T_1}) \otimes_{\mathbb{Q}} L^{v_2, \delta_2}(\mathfrak{M}_{0,T_2}) ,$$

where v_1, v_2 are the images of v defined in §6.5, and δ_1, δ_2 are the induced dihedral structures on T_1, T_2 . This proves that there is an isomorphism of filtered algebras $\text{Reg}(L^{v,\delta}(\mathfrak{M}_{0,S}), D_{ij}) \cong L^{v_1, \delta_1}(\mathfrak{M}_{0,T_1}) \otimes_{\mathbb{Q}} L^{v_2, \delta_2}(\mathfrak{M}_{0,T_2})$. On taking the tensor product with \mathcal{Z} , we obtain the statement of the theorem. \square

The theorem states that if we restrict a multiple polylogarithm of weight m to the divisor $u_{ij} = 0$, then we obtain a linear combination of products of multiple zeta values and multiple polylogarithms such that the total weight is at most m .

6.7. The regularised realisation of polylogarithms. Let $S = \{s_1, \dots, s_n\}$ with the obvious dihedral structure δ , and let $v \in V^{\delta}$. We can now define a realisation of $B(\mathfrak{M}_{0,S})$ which is regularised at v . Let us first suppose that v corresponds to the vertex $x_1 = x_2 = \dots = x_{\ell} = 0$ in cubical coordinates, in order to exploit the decomposition of $B(\mathfrak{M}_{0,S})$ as a product of shuffle algebras. The corresponding triangulation of the n -gon (S, δ) consists of all chords $\{\{2, 4\}, \dots, \{2, n\}\}$. The projection map onto $x_{\ell} = 0$ gives a fibration

$$\mathfrak{M}_{0,\{s_1, \dots, s_n\}} \longrightarrow \mathfrak{M}_{0,\{s_2, \dots, s_n\}} .$$

Correspondingly, we proved that there is a decomposition

$$B(\mathfrak{M}_{0,S}) = B(\mathfrak{M}_{0,S'}) \otimes_{\mathcal{O}(\mathfrak{m}_{0,S'})} B_{\mathfrak{m}_{0,S'}}(\mathbb{P}^1 \setminus \Sigma) ,$$

where $S' = \{s_2, \dots, s_n\}$, and Σ is given in §5.4. Now let v' denote the vertex corresponding to the restricted triangulation α' of S' with induced dihedral structure δ' . By proposition 6.15, there is a decomposition $L_{v,\delta} = h L_{v',\delta'}$, where h is a hyperlogarithm equation on $\mathbb{P}^1 \setminus \Sigma$ in the variable x_ℓ . We deduce that

$$L^{v,\delta}(\mathfrak{M}_{0,S}) = L^{v',\delta'}(\mathfrak{M}_{0,S'}) \otimes_{\mathcal{O}(\mathfrak{m}_{0,S'})} L_{\mathfrak{m}_{0,S'}}(\mathbb{P}^1 \setminus \Sigma) ,$$

where $L_{\mathfrak{m}_{0,S'}}(\mathbb{P}^1 \setminus \Sigma)$ denotes the $\mathcal{O}(\mathfrak{M}_{0,S'})$ -algebra generated by the coefficients of h . From the realisation (5.8) we obtain a realisation:

$$(6.43) \quad \rho_{S'} : B_{\mathfrak{m}_{0,S'}}(\mathbb{P}^1 \setminus \Sigma) \xrightarrow{\sim} L_{\mathfrak{m}_{0,S'}}(\mathbb{P}^1 \setminus \Sigma) ,$$

which is regularised at $x_\ell = 0$. It is an isomorphism of graded $\mathcal{O}(\mathfrak{M}_{0,S'})[\partial/\partial x_\ell]$ -algebras. If we iterate this argument, we obtain two analogous decompositions

$$(6.44) \quad \begin{aligned} B(\mathfrak{M}_{0,S}) &= \bigotimes_{1 \leq i \leq \ell} B_{\mathfrak{m}_{0,S_i}}(\mathbb{P}^1 \setminus \Sigma_i) , \\ L^{v,\delta}(\mathfrak{M}_{0,S}) &= \bigotimes_{1 \leq i \leq \ell} L_{\mathfrak{m}_{0,S'}}(\mathbb{P}^1 \setminus \Sigma_i) . \end{aligned}$$

for some subsets $S_1 \subsetneq S_2 \subsetneq \dots \subsetneq S_\ell \subsetneq S$ where $|S_1| = 3$, and $\Sigma_i \cong S_i$. Taking the tensor product of the fibre-wise isomorphisms (6.43), we obtain a map

$$\rho_{v,\delta} : B(\mathfrak{M}_{0,S}) \longrightarrow L^{v,\delta}(\mathfrak{M}_{0,S}) .$$

Theorem 6.26. *The map $\rho_{v,\delta}$ is an isomorphism of differential graded algebras. It follows that every $\mathcal{O}(\mathfrak{M}_{0,S})$ -differential subalgebra of $L^{v,\delta}(\mathfrak{M}_{0,S})$ is differentially simple, and that $L^{v,\delta}(\mathfrak{M}_{0,S})$ is a polynomial algebra. Furthermore,*

$$H^0(L^{v,\delta}(\mathfrak{M}_{0,S})) = \mathbb{Q} \quad \text{and} \quad H^i(L^{v,\delta}(\mathfrak{M}_{0,S})) = 0 \quad \text{for all } i \geq 1 .$$

The primitive of a closed form $f \in W^b \Omega^k L^{v,\delta}(\mathfrak{M}_{0,S})$ is of weight at most $b + 1$.

Proof. The proof of theorem 3.38 implies that the differential structure of the algebras $B(\mathfrak{M}_{0,S})$ and $L^{v,\delta}(\mathfrak{M}_{0,S})$ are uniquely determined from the tensor decompositions (6.44), since we have a fixed base point at infinity corresponding to v . It follows that $\rho_{v,\delta}$ is a map of differential graded algebras. The fact that it is an isomorphism then follows immediately from corollary 3.13. The rest of the theorem is a consequence of theorem 3.26 and corollary 3.40. \square

We obtain a similar decomposition for every vertex $v \in V^\delta$.

Corollary 6.27. *For each $v \in V^\delta$, there is a canonical realisation*

$$\rho_{v,\delta} : B(\mathfrak{M}_{0,S}) \longrightarrow L^{v,\delta}(\mathfrak{M}_{0,S}) ,$$

which is regularised at the vertex v .

The map $\rho_{v,\delta}$ has to be defined directly as follows. Recall from §6.2 that there is a decomposition $B(\mathfrak{M}_{0,S}) \cong B_{v,\delta}(\mathfrak{M}_{0,S}) \otimes \mathbb{Q}[[\omega_{i_1 j_1}, \dots, \omega_{i_\ell j_\ell}]]$ into convergent and

non-convergent words, where $\{i_1, j_1\}, \dots, \{i_\ell, j_\ell\}$ are the set of chords in the triangulation of the n -gon corresponding to v . Then $\rho_{v,\delta}$ is the unique homomorphism such that

$$\begin{aligned} \rho_{v,\delta}([\omega_{i_k j_k}]) &= \log u_{i_k j_k} \quad \text{for all } 1 \leq k \leq \ell, \\ \rho_{v,\delta}\left(\sum_I c_I [\omega_{i_1} | \dots | \omega_{i_n}]\right) &= \sum_I c_I \int_\gamma \omega_{i_n} \dots \omega_{i_1}, \end{aligned}$$

for all $\sum_I c_I [\omega_{i_1} | \dots | \omega_{i_n}] \in B_{v,\delta}(\mathfrak{M}_{0,S})$, where γ is a smooth path such that $\gamma(0) = v$ and $\gamma(1) = z \in \mathfrak{M}_{0,S}(\mathbb{C})$. Such an iterated integral converges, since $B_{v,\delta}(\mathfrak{M}_{0,S})$ is spanned by the set of integrable words no element of which ever ends in a symbol $\omega_{i_k j_k}$ for $1 \leq k \leq \ell$. The integrability condition (3.8) ensures that it only depends on the homotopy class of γ and therefore defines a multi-valued function on $\mathfrak{M}_{0,S}(\mathbb{C})$. Correspondingly, there is a decomposition

$$L^{v,\delta}(\mathfrak{M}_{0,S}) = L_c^{v,\delta}(\mathfrak{M}_{0,S}) \otimes_{\mathbb{Q}} \mathbb{Q}[\log u_{i_k j_k} : 1 \leq k \leq \ell],$$

where $L_c^{v,\delta}(\mathfrak{M}_{0,S}) = \rho_{v,\delta}(B_{v,\delta}(\mathfrak{M}_{0,S}))$ is the algebra generated by the coefficients of $f_{v,\delta}$ (defined in theorem 6.12). They are holomorphic in a neighbourhood of v .

7. PERIOD INTEGRALS ON $\overline{\mathfrak{M}}_{0,n}(\mathbb{R})$ AND GENERALISED SHUFFLE PRODUCTS.

Given a regular algebraic $n - 3$ -form on $\mathfrak{M}_{0,S}$, we give necessary and sufficient conditions for its integral over a fundamental cell $X_{S,\delta}$ to converge. We obtain a formula for the order of vanishing of any such form along any given divisor on $\overline{\mathfrak{M}}_{0,S} \setminus \mathfrak{M}_{0,S}$. Finally, we show how the double shuffle relations for multiple zeta values are a special case of generalised multiplicative structures on the set of all period integrals.

7.1. The set of all regular algebraic ℓ -forms on $\mathfrak{M}_{0,S}$ can be written in terms of a canonical dihedrally-invariant form which we construct as follows. Let δ be a fixed dihedral structure on S , and correspondingly, write $S = \{s_1, \dots, s_n\}$. First we define the following form on $(\mathbb{P}^1)_*^n$, where the indices are taken modulo n :

$$(7.1) \quad \tilde{\omega}_{S,\delta} = \bigwedge_{j=1}^n \frac{dz_j}{z_j - z_{j+2}} .$$

The forms $\tilde{\omega}_{S,\delta}$ are $\mathrm{PSL}_2(\mathbb{C})$ -invariant, since if we set

$$z'_i = \frac{\alpha z_i + \beta}{\gamma z_i + \delta} , \quad \text{for } 1 \leq i \leq n , \quad \text{where } \begin{pmatrix} \alpha & \beta \\ \gamma & \delta \end{pmatrix} \in \mathrm{PSL}_2(\mathbb{C}) ,$$

then $dz'_i = (\gamma z_i + \delta)^{-2} dz_i$ and $z'_i - z'_j = (\gamma z_i + \delta)^{-1} (\gamma z_j + \delta)^{-1} (z_i - z_j)$, and therefore $\tilde{\omega}_{S,\delta}$ is unchanged on replacing each z_i by z'_i . In order to define a form on $\mathfrak{M}_{0,S}$, consider the quotient map $p : (\mathbb{P}^1_*)^n \rightarrow \mathfrak{M}_{0,S}$, which has fibres PSL_2 . Let v denote a fixed non-zero algebraic invariant 3-form on $\mathrm{PSL}_2(\mathbb{C})$ which is defined over \mathbb{Q} . This is uniquely determined up to a non-zero rational multiple. Then there exists a unique form $\omega_{S,\delta}$ on $\mathfrak{M}_{0,S}$ such that

$$p^*(\omega_{S,\delta}) \wedge v = \tilde{\omega}_{S,\delta} .$$

The form $\omega_{S,\delta}$ is defined over \mathbb{Q} , and is D_{2n} -invariant by construction. In simplicial coordinates (2.3), and using the $\mathrm{PSL}_2(\mathbb{C})$ -invariance of (7.1), we can normalise the rational coefficient of $\omega_{S,\delta}$ such that:

$$(7.2) \quad \omega_{S,\delta} = \frac{dt_1 \wedge \dots \wedge dt_\ell}{t_2(t_3 - t_1)(t_4 - t_2) \dots (t_\ell - t_{\ell-2})(1 - t_{\ell-1})} ,$$

if $\ell \geq 2$, and $\omega_{S,\delta} = dt_1$ if $\ell = 1$. In dihedral coordinates, one has $\omega_{S,\delta} = du_{24}$ if $\ell = 1$, and if $\ell \geq 2$, one can write (7.2) using (2.8) as follows:

$$(7.3) \quad \omega_{S,\delta} = \frac{du_{24} \wedge du_{25} \wedge \dots \wedge du_{2n-1} \wedge du_{2n}}{(1 - u_{24}u_{25})(1 - u_{25}u_{26}) \dots (1 - u_{2n-1}u_{2n})} .$$

The latter representation is not unique because of the various relations between the functions u_{ij} and their differentials. The form $\omega_{S,\delta}$ clearly defines a meromorphic form on the compactification $\overline{\mathfrak{M}}_{0,S}$. For any boundary divisor $D \subset \overline{\mathfrak{M}}_{0,S} \setminus \mathfrak{M}_{0,S}$ we denote by $\mathrm{ord}_D \omega_{S,\delta}$ the order of vanishing of $\omega_{S,\delta}$ along D .

Lemma 7.1. *The form $\omega_{S,\delta}$ has neither zeros nor poles on $\mathfrak{M}_{0,S}^\delta \setminus \mathfrak{M}_{0,S}$.*

Proof. In cubical coordinates, $\omega_{S,\delta}$ has the representation:

$$(7.4) \quad \omega_{S,\delta} = \frac{dx_1 \wedge \dots \wedge dx_\ell}{(1 - x_1x_2) \dots (1 - x_{\ell-1}x_\ell)} .$$

It is clear that $\omega_{S,\delta}$ is not identically zero nor infinite along the divisors $x_i = 0$, for $1 \leq i \leq \ell$. In other words, the order of vanishing of $\omega_{S,\delta}$ is zero along the divisor

$u_{2i} = 0$ for each $4 \leq i \leq n$. But since $\omega_{S,\delta}$ is D_{2n} -invariant, it follows that the order of vanishing of $\omega_{S,\delta}$ is zero along all divisors at finite distance $u_{ij} = 0$, where $\{i, j\} \in \chi_{S,\delta}$. \square

In other words, given any fixed dihedral structure δ on S , we can define $\omega_{S,\delta}$ to be the unique (up to multiplication by \mathbb{Q}^\times) non-zero volume form on $\mathfrak{M}_{0,S}(\mathbb{R})$ which has no zeros or poles at finite distance. Equivalently, it has no zeros or poles on the boundary of the closed Stasheff polytope $\bar{X}_{S,\delta}$.

It follows from (2.9) that every algebraic volume form on $\mathfrak{M}_{0,S}^\delta(\mathbb{R})$ can be written as a linear combination of forms

$$(7.5) \quad \prod_{\{i,j\} \in \chi_{S,\delta}} u_{ij}^{\alpha_{ij}} \omega_{S,\delta}, \quad \text{where } \alpha_{ij} \in \mathbb{Z} \text{ for each } \{i, j\} \in \chi_{S,\delta}.$$

Now suppose that we are given a collection of coefficients $\alpha = (\alpha_{ij})_{\{i,j\} \in \chi_{S,\delta}}$ which are all non-negative. We define the following family of period integrals:

$$(7.6) \quad I_{S,\delta}(\alpha_{ij}) = \int_{\bar{X}_{S,\delta}} \prod_{\{i,j\} \in \chi_{S,\delta}} u_{ij}^{\alpha_{ij}} \omega_{S,\delta}.$$

The integral is finite because each function u_{ij} is continuous and bounded on the compact set $\bar{X}_{S,\delta}$. Since $\omega_{S,\delta}$ is positive on $\bar{X}_{S,\delta}$ and invariant under the action of D_{2n} , it follows that $I_{S,\delta}(\alpha_{ij})$ is also positive, and we have a dihedral transformation formula:

$$(7.7) \quad I_{S,\delta}(\alpha_{ij}) = I_{S,\delta}(\alpha_{\sigma(i)\sigma(j)}) \quad \text{for all } \sigma \in D_{2n}.$$

These integrals can be written explicitly in simplicial and cubical coordinates.

Lemma 7.2. *In cubical coordinates, we have the following formula:*

$$(7.8) \quad I_{S,\delta}(\alpha_{ij}) = \int_{[0,1]^\ell} \prod_{i=1}^{\ell} x_i^{\alpha_i} (1-x_i)^{b_i} \prod_{1 \leq i < j \leq \ell} (1-x_i x_{i+1} \dots x_j)^{c_{ij}} dx_1 \dots dx_\ell,$$

where the indices $a_i, b_i, c_{ij} \in \mathbb{Z}$ are given by:

$$(7.9) \quad \begin{aligned} a_i &= \alpha_{2i+3}, \\ b_i &= \alpha_{i+2i+4}, \\ c_{i\ i+1} &= \alpha_{i+2i+5} - \alpha_{i+2i+4} - \alpha_{i+3i+5} - 1, \\ c_{ij} &= \alpha_{i+3j+3} + \alpha_{i+2j+4} - \alpha_{i+2j+3} - \alpha_{i+3j+4}, \quad \text{if } j \geq i+2. \end{aligned}$$

Proof. In cubical coordinates, the domain of integration is $\bar{X}_{S,\delta} \cong [0,1]^\ell$, and the only factors that occur in the denominator of $\omega_{S,\delta}$ are $(1-x_i x_{i+1})$ by (7.4). Using the definition of the cross-ratios u_{ij} , we can rewrite the function

$$f = \prod_{\{i,j\} \in \chi_{S,\delta}} u_{ij}^{\alpha_{ij}} = \pm \prod_{1 \leq p < q \leq n} (z_p - z_q)^{s_{pq}},$$

where the indices s_{pq} are given by $s_{pq} = \alpha_{p-1q} + \alpha_{pq-1} - \alpha_{p-1q-1} - \alpha_{pq}$, and where we set $\alpha_{i\ i+1} = \alpha_{i\ i} = 0$. In cubical coordinates, we have $z_1 = 1, z_2 = \infty, z_3 = 0$, and $z_{i+3} = x_i \dots x_\ell$, for $1 \leq i \leq \ell$. If we put the various elements together, we obtain the formulae for b_i and c_{ij} given above. The formulae for a_i are easily deduced using the fact that $x_1 = u_{24}, \dots, x_\ell = u_{2n}$. \square

A special sub-family of these integrals were considered in [Zu], [Fi2], [Zl], where it was also conjectured that they are expressible in terms of multiple zeta values. It is easy to verify that the change of variables matrix given by (7.9) is invertible over \mathbb{Z} .

Similarly, in simplicial coordinates one can verify that

$$I_{S,\delta}(\alpha_{ij}) = \int_{\Delta} \prod_{i=1}^{\ell} t_i^{a'_i} (1-t_i)^{b'_i} \prod_{1 \leq i < j \leq \ell} (t_j - t_i)^{c'_{ij}} \frac{dt_1 \dots dt_{\ell}}{t_2(t_3 - t_1) \dots (t_{\ell} - t_{\ell-2})(1 - t_{\ell-1})},$$

where $\Delta = \{0 < t_1 < \dots < t_{\ell} < 1\}$ denotes the unit simplex, and where

$$\begin{aligned} a'_i &= \alpha_{3i+2} + \alpha_{2i+3} - \alpha_{3i+3} - \alpha_{2i+2}, & 1 \leq i \leq \ell \\ b'_i &= \alpha_{ni+3} + \alpha_{1i+2} - \alpha_{ni+2} - \alpha_{1i+3}, & 1 \leq i \leq \ell \\ c'_{ij} &= \alpha_{i+2j+3} + \alpha_{i+3j+2} - \alpha_{i+3j+3} - \alpha_{i+2j+2}, & 1 \leq i < j \leq \ell \end{aligned}$$

where we set $\alpha_{ii+1} = \alpha_{ii} = 0$ as above. Once again, it is not difficult to verify that the corresponding change of variables matrix is invertible over \mathbb{Z} (this is implied by equation (6.17)).

7.2. Relative periods and mixed Hodge structures. Let $n = |S| = \ell + 3$, and let A, B denote two sets of divisors at infinity on $\overline{\mathfrak{M}}_{0,S} \setminus \mathfrak{M}_{0,S}$, where we assume that $A \cap B$ is of codimension at least 2, *i.e.*, A and B have no shared irreducible components. Consider the relative cohomology group

$$(7.10) \quad H^{\ell}(\overline{\mathfrak{M}}_{0,S} \setminus A, B \setminus B \cap A),$$

which has a canonical mixed Hodge structure [De]. Since the divisor $A \cup B$ is globally normal crossing, this can be computed using the techniques of [G-S], [V], and it is easily verified that it is of Tate type. Goncharov and Manin construct an object in the abelian category of mixed Tate motives $\text{MT}(\mathbb{Q})$ over \mathbb{Q} [Go, D-G], whose Hodge realisation is the mixed Hodge structure (7.10). They then show that this motive is unramified over \mathbb{Z} . We shall write the corresponding motive and mixed Hodge structure with the same symbol. No confusion arises because the Hodge realisation functor is fully faithful over \mathbb{Q} ([D-G], proposition 2.9). Suppose that we are given a relative homology cycle

$$[\Delta_B] \in H_{\ell}(\overline{\mathfrak{M}}_{0,S}, B).$$

We can assume that this class is represented by a smooth compact real submanifold with corners Δ_B whose codimension- k boundary is contained in the k -stratum of B . More precisely, if B consists of irreducible components B_i , for $1 \leq i \leq N$, then

$$(7.11) \quad \partial^k \Delta_B = \Delta_B \cap \bigcap_{i_1, \dots, i_k} B_{i_1} \cap \dots \cap B_{i_k}.$$

Suppose that we are given an algebraic ℓ -form Ω_A on $\mathfrak{M}_{0,S}$ which is defined over \mathbb{Q} and whose singularities are contained in A . Then the *relative period integral* of Ω_A along Δ_B is defined to be

$$(7.12) \quad \int_{\Delta_B} \Omega_A \in \mathbb{C}.$$

By a higher-dimensional version of Cauchy's theorem, this integral is invariant under continuous deformations of Δ_B relative to B . We can thus assume that Δ_B is disjoint from A , and therefore the integral is bounded, since Ω_A is continuous on

Δ_B , which is compact. Note that the integral depends on the *relative* cohomology classes of Ω_A in $H^\ell(\overline{\mathfrak{M}}_{0,S} \setminus A, B \setminus B \cap A)$, and Δ_B in $H_\ell(\overline{\mathfrak{M}}_{0,S} \setminus A, B \setminus B \cap A)$.

Lemma 7.3. $\text{gr}_0^W H_\ell(\overline{\mathfrak{M}}_{0,S}, B)$ is spanned by the homology classes of a number of cells $X_{S,\delta}$, where δ is in a certain set of dihedral structures which depends upon B .

Proof. The relative cohomology group $H_\ell(\overline{\mathfrak{M}}_{0,S}, B)$ can be computed using the spectral sequence of the complex

$$\overline{\mathfrak{M}}_{0,S} \leftarrow \bigsqcup_i B_i \leftarrow \bigsqcup_{i,j} B_{i,j} \leftarrow \dots \leftarrow \bigsqcup_{|I|=\ell} B_I,$$

where B is the union of a set of divisors B_i , and $B_I = \bigcap_{i \in I} B_i$. The spectral sequence degenerates on the E^2 level and it follows that

$$\text{gr}_0^W H_\ell(\overline{\mathfrak{M}}_{0,S}, B) \cong \ker \left(\bigoplus_{|I|=\ell} H_0(B_I) \longrightarrow \bigoplus_{|J|=\ell-1} H_0(B_J) \right).$$

In the simplicial complex defined by B , this is just $\ker(\mathbb{C}^p \rightarrow \mathbb{C}^e)$ where p is the number of points, *i.e.*, ℓ -fold intersections of divisors, and e is the number of edges, *i.e.*, $\ell - 1$ -fold intersections. This also computes the number of independent cells in $\overline{\mathfrak{M}}_{0,S}(\mathbb{R})$ bounded by $B \cap \overline{\mathfrak{M}}_{0,S}(\mathbb{R})$. Since $\mathfrak{M}_{0,S}(\mathbb{R})$ is tessellated by the cells $X_{S,\delta}$ (lemma 2.22), they must generate $\text{gr}_0^W H_\ell(\overline{\mathfrak{M}}_{0,S}, B)$. \square

Lemma 7.4. Every relative period integral over a union of cells $\overline{X}_{S,\delta_i}$ is a \mathbb{Q} -linear combination of $I_{S,\delta}(\alpha_{ij})$, where the α_{ij} are all non-negative.

Proof. Fix a dihedral structure δ on S . Any such integral I can be written:

$$I = \sum_{i=1}^N \int_{\overline{X}_{S,\delta_i}} \omega_i = \int_{\overline{X}_{S,\delta}} \sum_{i=1}^N \sigma_i^*(\omega_i),$$

where $\omega_i \in \Omega^\ell(\mathfrak{M}_{0,S}(\mathbb{R}))$, and where σ_i is an element of $\mathfrak{S}(S)$ which maps the dihedral structure δ_i onto δ . The right-hand side can be written

$$I = \int_{\overline{X}_{S,\delta}} f \omega_{S,\delta},$$

where $f \in \mathbb{Q}[u_{ij}, u_{ij}^{-1}]$ is a regular function on $\mathfrak{M}_{0,S}$. Note that by lemma 4.9 this integral converges absolutely if and only if $f \omega_{S,\delta}$ has no poles along $\partial \overline{X}_{S,\delta}$. Since $\partial \overline{X}_{S,\delta}$ is the union of divisors $D_{ij} = \{u_{ij} = 0\}$, and since $\text{ord}_{D_{ij}} f \omega_{S,\delta} = \text{ord}_{D_{ij}} f$ (by lemma 7.1), this implies that $f \in \mathbb{Q}[u_{ij}]$. Since f is a polynomial in the u_{ij} , it can be written as a linear combination of monomials with positive exponents, or in other words, I is a finite \mathbb{Q} -linear combination of integrals $I_{S,\delta}(\alpha_{ij})$, with α_{ij} all non-negative. \square

In order to rephrase the above in motivic terms, we need to recall the notion of framings from [Go1-2], [BGSV]. Let $m \geq 0$ denote an integer. An m -framing on a mixed Tate motive (or its Hodge realisation) is given by two morphisms

$$v : \mathbb{Q}(-m) \rightarrow \text{gr}_{2m}^W M \quad \text{and} \quad f : \mathbb{Q}(0) \rightarrow (\text{gr}_0^W M)^\vee.$$

Two framed mixed Tate motives (M, v, f) and (M', v', f') are said to be equivalent if there is a morphism $M \rightarrow M'$ which respects the framings. The framings on the

motive (7.10) were defined in [G-M] as follows. There are isomorphisms

$$\begin{aligned} \mathrm{gr}_0^W H_\ell(\overline{\mathfrak{M}}_{0,S} \setminus A, B \setminus B \cap A) &\cong \mathrm{gr}_0^W H_\ell(\overline{\mathfrak{M}}_{0,S}, B) , \\ \mathrm{gr}_{2\ell}^W H^\ell(\overline{\mathfrak{M}}_{0,S} \setminus A, B \setminus B \cap A) &\cong \mathrm{gr}_{2\ell}^W H^\ell(\overline{\mathfrak{M}}_{0,S} \setminus A) . \end{aligned}$$

Therefore, the classes $[\Delta_B] \in \mathrm{gr}_0^W H_\ell(\overline{\mathfrak{M}}_{0,S}, B)$ and $[\Omega_A] \in \mathrm{gr}_{2\ell}^W H^\ell(\overline{\mathfrak{M}}_{0,S} \setminus A)$ define an ℓ -framing on (7.10). Note that these framings could be zero.

We introduce a simplified variant of the above motives. Let δ denote a fixed dihedral structure on S and let D_δ denote the set of divisors at finite distance in $\mathfrak{M}_{0,S}^\delta$. These are the affine varieties which bound the fundamental cell $\overline{X}_{S,\delta}$. Let $\omega \in \Omega^\ell(\mathfrak{M}_{0,S})$ denote an algebraic ℓ -form with no singularities along D_δ , which is defined over \mathbb{Q} . Let us define the ℓ -framed mixed Tate motive:

$$(7.13) \quad m_{S,\delta}(\omega) = (H^\ell(\mathfrak{M}_{0,S}^\delta, D_\delta), [\overline{X}_{S,\delta}], [\omega]) ,$$

equipped with the framings given by the class of the fundamental cell $\Delta_B = \overline{X}_{S,\delta}$, and the class of ω . The framed motives $m_{S,\delta}(\omega)$ are more convenient to work with because the varieties $\mathfrak{M}_{0,S}^\delta$ are affine, and we do not need to keep track of the divisor data at infinity. Lemmas 7.3 and 7.4 imply that the framed mixed Tate motive $(H^\ell(\overline{\mathfrak{M}}_{0,S} \setminus A, B \setminus B \cap A), [\Delta_B], [\Omega_A])$, is equivalent to a linear combination of motives:

$$m_{S,\delta}(f \omega_{S,\delta}) , \quad \text{where } f = \prod_{\{i,j\} \in \chi_{S,\delta}} u_{ij}^{\alpha_{ij}} .$$

The equivalence is given by natural inclusion maps between moduli spaces, the action of the symmetric group, and the additivity of framed objects with respect to their framings.

7.3. Formulae for the divisor of singularities. In order to compute the divisor of singularities of an arbitrary form (7.5), it suffices to compute the order of the canonical form $\omega_{S,\delta}$ along each divisor at infinity. This is easily done by exploiting the action of the symmetric group.

Proposition 7.5. *Let $|S| = n = \ell + 3$, and let D denote the divisor given by the stable partition $S^1 \cup S^2 = S$ (proposition 2.30). Then*

$$\mathrm{ord} \omega_{S,\delta} = \frac{\ell - 1}{2} - \frac{1}{2} \sum_{i \in \mathbb{Z}/n\mathbb{Z}} \mathbb{I}_D(i, i+2) ,$$

where the notation \mathbb{I}_D is defined by equation (2.39) in §2.6.

Proof. Let $k \geq 2$ denote the number of elements in S^1 . Let σ denote a permutation $\sigma \in \mathfrak{S}(n)$ such that $\sigma^{-1}(S^1) = \{1, 2, \dots, k\}$. By (7.1), we have

$$\sigma^*(\tilde{\omega}_{S,\delta}) = \pm \prod_{i \in \mathbb{Z}/n\mathbb{Z}} \left(\frac{z_i - z_{i+2}}{z_{\sigma(i)} - z_{\sigma(i+2)}} \right) \tilde{\omega}_{S,\delta} .$$

By passing to the quotient $p : (\mathbb{P}^1)_*^S \rightarrow \mathfrak{M}_{0,S}$, we have

$$\mathrm{ord}_D \omega_{S,\delta} = \mathrm{ord}_D \sigma^*(\omega_{S,\delta}) - \mathrm{ord}_D f ,$$

where the function

$$f = \prod_{i \in \mathbb{Z}/n\mathbb{Z}} \left(\frac{z_i - z_{i+2}}{z_{\sigma(i)} - z_{\sigma(i+2)}} \right)$$

is homogeneous and $\mathrm{PSL}_2(\mathbb{C})$ -invariant by the remarks in §7.1. It can therefore be written as a product of cross-ratios and is a well-defined function on $\mathfrak{M}_{0,S}$. Now

$\text{ord}_D \sigma^*(\omega_{S,\delta}) = \text{ord}_{\{1,\dots,k\}} \omega_{S,\delta} = 0$, since the divisor given by the stable partition $\{1, \dots, k\} \cup \{k+1, \dots, n\}$ is $D_{kn} = \{u_{kn} = 0\}$, and we know by lemma 7.1 that $\omega_{S,\delta}$ has no zeros or poles at finite distance. Therefore

$$(7.14) \quad \text{ord}_D \omega_{S,\delta} = -\text{ord}_D f ,$$

and it suffices to compute the zeros and poles of f . Recall from corollary 2.31 that

$$\text{ord}_D \frac{(z_i - z_k)(z_j - z_l)}{(z_i - z_l)(z_j - z_k)} = \frac{1}{2} \left[\mathbb{I}_D(i, k) + \mathbb{I}_D(j, l) - \mathbb{I}_D(i, l) - \mathbb{I}_D(j, k) \right] .$$

We deduce that

$$\text{ord}_D f = \frac{1}{2} \sum_{i \in \mathbb{Z}/n\mathbb{Z}} \left(\mathbb{I}_D(i, i+2) - \mathbb{I}_D(\sigma(i), \sigma(i+2)) \right) .$$

But $\{\sigma(i), \sigma(i+2)\} \subset S^1$ if and only if $\{i, i+2\} \subset \{1, \dots, k\}$. The number of such pairs is exactly $k-2$. Likewise, the number of i such that $\{\sigma(i), \sigma(i+2)\} \subset S^2$ is $n-k-2$. It follows that the second quantity in the sum directly above is $n-4 = \ell-1$. This completes the proof on substituting into (7.14). \square

We immediately deduce the following formula for the order of vanishing of an arbitrary form along any divisor $D \subset \overline{\mathfrak{M}}_{0,S} \setminus \mathfrak{M}_{0,S}$. Let

$$f = \prod_{\{i,j\} \in \chi_{S,\delta}} u_{ij}^{\alpha_{ij}} , \quad \alpha_{ij} \in \mathbb{Z} .$$

Corollary 7.6. *Let D and f be as above. Then*

$$\begin{aligned} 2 \text{ord}_D f \omega_{S,\delta} &= \sum_{\{i,j\} \in \chi_{S,\delta}} \alpha_{ij} \left[\mathbb{I}_D(i, j+1) + \mathbb{I}_D(i+1, j) - \mathbb{I}_D(i, j) - \mathbb{I}_D(i+1, j+1) \right] \\ &\quad + (\ell-1) - \sum_{i \in \mathbb{Z}/n\mathbb{Z}} \mathbb{I}_D(i, i+2) . \end{aligned}$$

Proof. This follows immediately from the additivity of ord_D and the fact that

$$2 \text{ord}_D u_{ij} = 2 \text{ord}_D [i+1|j+1] = \mathbb{I}_D(i, j+1) + \mathbb{I}_D(i+1, j) - \mathbb{I}_D(i, j) - \mathbb{I}_D(i+1, j+1) .$$

\square

Note that along each divisor at finite distance $D_{ij} = \{u_{ij} = 0\}$, where $\{i, j\} \in \chi_{S,\delta}$, we clearly have $\text{ord}_D(f) = \alpha_{ij}$. In total, there are as many boundary divisors $D \in \overline{\mathfrak{M}}_{0,S}$ as there are partitions of S into two sets, each containing at least two elements. These number $2^{n-1} - n - 1$, but there are only $n(n-3)/2$ parameters α_{ij} , which implies that there are many relations between the quantities $\text{ord}_D f$, for varying D . The following lemma gives an alternative approach for computing the orders of functions along divisors.

Lemma 7.7. *Let D be the divisor of $\overline{\mathfrak{M}}_{0,S} \setminus \mathfrak{M}_{0,S}$ corresponding to a stable partition $S_1 \cup S_2 = S$. For each two-element subset $T = \{s_i, s_j\} \subset S_1$, let D_T denote the divisor given by the partition T and its complement $S \setminus T$. Then for any function $f \in \mathbb{Q}(\mathfrak{M}_{0,S})$,*

$$(7.15) \quad \text{ord}_D f = \sum_{T \subset S_1, |T|=2} \text{ord}_{D_T} f .$$

Proof. It suffices to verify the formula for the function $f = u_{ij}$, where $\{i, j\} \in \chi_{S, \delta}$, since it is compatible with products. By corollary 2.31,

$$\text{ord}_D u_{ij} = \begin{cases} -1 & \text{if } i, j \in S_1, \quad \text{and } i+1, j+1 \in S_2, \\ 1 & \text{if } i, j+1 \in S_1 \quad \text{and } i+1, j \in S_2, \end{cases}$$

and is 0 otherwise. One can check that the identity holds for two-element subsets of $S_1 \cap \{i, i+1, j, j+1\}$, from which it follows in general. For example, if $S_1 \cap \{i, i+1, j, j+1\} = \{i, i+1, j+1\}$, then $\text{ord}_D u_{ij} = 0$ and this is equal to

$$\text{ord}_{D_{\{i, i+1\}}} u_{ij} + \text{ord}_{D_{\{i, j+1\}}} u_{ij} + \text{ord}_{D_{\{i+1, j+1\}}} u_{ij} = 0 + 1 - 1.$$

□

7.4. Singularities of the Kontsevich multiple zeta value forms. There is a special set of ℓ -forms on $\mathfrak{M}_{0, S}$ corresponding to the iterated integral representations of multiple zeta values due to Kontsevich. Let $n \geq 5$. We apply the previous proposition to compute the divisor of singularities of each such form and retrieve one of the results of [G-M]. Let $\underline{\epsilon} = (\epsilon_1, \dots, \epsilon_\ell)$ where $\epsilon_1, \dots, \epsilon_\ell \in \{0, 1\}$. We define

$$(7.16) \quad \gamma_i = 3 - 2\epsilon_i \in \{1, 3\}, \quad \text{for } 1 \leq i \leq \ell,$$

and set

$$(7.17) \quad \Omega(\underline{\epsilon}) = [5 \ n \ | \ 3 \ 2] [2 \ n \ | \ 1 \ 3]^{\epsilon_\ell} \prod_{i=1}^{\ell-1} [i+5 \ \gamma_i \ | \ i+3 \ 2] \omega_{S, \delta}.$$

The term in the product corresponding to $i = \ell - 1$ requires explanation. We define $[n+1 \ \gamma_{\ell-1} \ | \ n-1 \ 2] = [1 \ 3 \ | \ n-1 \ 2]$ if $\gamma_{\ell-1} = 3$, and define it to be 1 if $\gamma_{\ell-1} = 1$. We can write this expression in explicit simplicial coordinates (2.3) by setting $z_1 = 1$, $z_2 = \infty$ and $z_3 = 0$. If we define $t_{\ell+1} = 1$, one can verify using (7.2) that

$$(7.18) \quad \Omega(\underline{\epsilon}) = \frac{t_2}{t_\ell} \left(\frac{t_\ell}{t_\ell - 1} \right)^{\epsilon_\ell} \prod_{i=1}^{\ell-1} \left(\frac{t_{i+2} - t_i}{\epsilon_i - t_i} \right) \omega_{S, \delta} = \bigwedge_{i=1}^{\ell} \frac{dt_i}{\epsilon_i - t_i}.$$

Let $X = \{x_0, x_1\}$ be an alphabet with two letters as considered in §5.5. Assume that $\epsilon_1 = 1$ and $\epsilon_\ell = 0$, and define a word $w = x_{\epsilon_\ell} \dots x_{\epsilon_1} \in x_0 X^* x_1$. Let $r_\epsilon = \sum_{i=1}^{\ell} \epsilon_i$. It follows from (2.34) and a well-known formula for $\zeta(w)$ that

$$(7.19) \quad \int_{X_{S, \delta}} \Omega(\underline{\epsilon}) = \int_{0 < t_1 < \dots < t_\ell < 1} \bigwedge_{i=1}^{\ell} \frac{dt_i}{\epsilon_i - t_i} = (-1)^{\ell - r_\epsilon} \zeta(w).$$

The integral converges if and only if $\epsilon_1 = 1$ and $\epsilon_\ell = 0$. It follows that every multiple zeta value of weight ℓ occurs as a relative period of $\mathfrak{M}_{0, \ell+3}(\mathbb{R})$ [G-M].

Lemma 7.8. *Let $\underline{\epsilon} = (\epsilon_1, \dots, \epsilon_\ell)$ with $\epsilon_i \in \{0, 1\}$ for all $1 \leq i \leq \ell$. Then*

$$2 \text{ord}_D \Omega(\underline{\epsilon}) = \ell - 1 + \sum_{i=1}^{\ell} [\mathbb{I}_D(2, \gamma_i) - \mathbb{I}_D(i+3, \gamma_i)] - \sum_{k \neq 2} \mathbb{I}_D(2, k) - \mathbb{I}_D(1, 3),$$

where $\gamma_i \in \{1, 3\}$ is defined in (7.16).

Proof. First we assume that $\epsilon_\ell = 0$, and therefore $\gamma_\ell = 3$. It follows from (7.17) that

$$(7.20) \quad \begin{aligned} 2 \operatorname{ord}_D \Omega(\underline{\epsilon}) &= \sum_{i=1}^{\ell-1} \mathbb{I}_D(i+3, i+5) + \mathbb{I}_D(2, \gamma_i) - \mathbb{I}_D(2, i+5) - \mathbb{I}_D(i+3, \gamma_i) \\ &+ \mathbb{I}_D(3, 5) + \mathbb{I}_D(2, n) - \mathbb{I}_D(2, 5) - \mathbb{I}_D(3, n) + \operatorname{ord}_D \omega_{S, \delta}, \end{aligned}$$

and the formula stated above follows on substituting the expression for $\operatorname{ord}_D \omega_{S, \delta}$ given in proposition 7.5. In the case where $\epsilon_\ell = 1$, $\gamma_\ell = 1$, a similar formula for $\Omega(\underline{\epsilon})$ holds except that one must multiply by an extra cross-ratio $[2n|13]$. This contributes

$$\mathbb{I}_D(2, 1) - \mathbb{I}_D(n, 1) - (\mathbb{I}_D(2, 3) - \mathbb{I}_D(n, 3))$$

in the expression above, and this is precisely what is required for the formula to hold in this case also. \square

Let $D \subset \overline{\mathfrak{M}}_{0, S} \setminus \mathfrak{M}_{0, S}$ be the divisor corresponding to a stable partition $S_1 \cup S_2$ of S . Then, up to permuting the sets S_1 and S_2 , D is one of the following four types, where $A \cup B$ is a partition of $\{s_4, \dots, s_n\}$:

- (1) $S_1 = \{s_1, s_2, s_3\} \cup A$, $S_2 = B$.
- (2) $S_1 = \{s_1, s_3\} \cup A$, $S_2 = \{s_2\} \cup B$.
- (3) $S_1 = \{s_1, s_2\} \cup A$, $S_2 = \{s_3\} \cup B$.
- (4) $S_1 = \{s_2, s_3\} \cup A$, $S_2 = \{s_1\} \cup B$.

Corollary 7.9. *Let $A_0 = A \cap \{s_{i+3} \text{ for } 1 \leq i \leq \ell \text{ such that } \epsilon_i = 0\}$, $A_1 = A \setminus A_0$, and define B_0, B_1 , similarly. Then, according to each of the cases above,*

$$\operatorname{ord}_D \Omega(\underline{\epsilon}) = \begin{cases} |B| - 2 & \text{if } D \text{ is as in case (1) ,} \\ -1 & \text{if } D \text{ is as in case (2) ,} \\ |B_1| - 1 & \text{if } D \text{ is as in case (3) ,} \\ |B_0| - 1 & \text{if } D \text{ is as in case (4) .} \end{cases}$$

Proof. In case (1), the formula stated in the previous lemma gives, term by term,

$$2 \operatorname{ord}_D(\Omega(\underline{\epsilon})) = \ell - 1 + \ell - |A| - (|A| + 2) - 1,$$

and the formula follows, since $\ell = |A| + |B|$. In case (2), it gives

$$2 \operatorname{ord}_D(\Omega(\underline{\epsilon})) = \ell - 1 + 0 - |A| - |B| - 1 = -2.$$

In case (3), we have $S_1 = \{s_1, s_2\} \cup A_0 \cup A_1$ and $S_2 = \{s_3\} \cup B_0 \cup B_1$. The formula in the previous lemma gives, term by term:

$$2 \operatorname{ord}_D(\Omega(\underline{\epsilon})) = \ell - 1 + (|A_1| + |B_1|) - (|B_0| + |A_1|) - (1 + |A_0| + |A_1|) - 0,$$

but since $\ell = |A_0| + |A_1| + |B_0| + |B_1|$, this is just $2|B_1| - 2$, as required. The formula for case (4) follows by symmetry. \square

In case (1), we must have $|S_2| = |B| \geq 2$, otherwise the partition $S_1 \cup S_2$ is not stable, so no singularity ever occurs along such a divisor. It follows that the divisor of singularities of $\Omega(\underline{\epsilon})$ are precisely those divisors of type (2), and those of type (3) (resp. (4)) for which B_1 (resp. B_0) is empty. Let us set $s_1 = 1$, $s_2 = \infty$, and $s_3 = 0$, as usual. Then the divisors of type (2) correspond to the divisors which are called ‘type ∞ ’ in [G-M]. The divisors of type (3) for which there is a pole are partitions of the form $\{1, \infty\} \cup A$ and $\{0\} \cup B$, where $B = B_0$ and hence $B \subset \{s_{i+3} : \epsilon_i = 0\}$. These are exactly the divisors of ‘type 0’ according to [G-M]. Similarly, our type

(4) above corresponds to ‘type 1’ and the previous result implies proposition 3.1 of [Go-Ma]. Note that the above proof only uses the action of the symmetric group and does not use any blow-ups.

7.5. Generalised products and the double shuffle relations. In §2.7 we considered non-degenerate coordinate systems

$$f = \prod_{i=1}^k f_{T_i} : \mathfrak{M}_{0,S} \longrightarrow \prod_{i=1}^k \mathfrak{M}_{0,T_i} ,$$

where the sets T_i cover S and the dimensions satisfy (2.43). Since the dimension of $\mathfrak{M}_{0,T_i}(\mathbb{R})$ is $|T_i| - 3$, the Künneth formula gives an isomorphism

$$\bigotimes_{i=1}^k H^{|T_i|-3}(\mathfrak{M}_{0,T_i}(\mathbb{R})) \cong H^{|S|-3}(\prod_{i=1}^k \mathfrak{M}_{0,T_i}(\mathbb{R})) .$$

We deduce the existence of a multiplication map for volume forms:

$$(7.21) \quad f^* : \bigotimes_{i=1}^k H^{|T_i|-3}(\mathfrak{M}_{0,T_i}(\mathbb{R})) \longrightarrow H^{|S|-3}(\mathfrak{M}_{0,S}(\mathbb{R})) .$$

This in turn gives a product formula for period integrals on the spaces $\mathfrak{M}_{0,S}(\mathbb{R})$. If S has dihedral structure δ , then it induces dihedral structures δ_i on T_i . Recall that the fundamental domains $\prod_{i=1}^k X_{T_i,\delta_i}$ and $X_{S,\delta}$ are related by the set G_f defined in (2.44) via the formula (2.45).

Corollary 7.10. *Let $\omega_i \in H^{|T_i|-3}(\mathfrak{M}_{0,T_i}(\mathbb{R}))$, for $1 \leq i \leq k$. Then*

$$\prod_{i=1}^k \int_{X_{T_i,\delta_i}} \omega_i = \sum_{\gamma \in G_f} \int_{X_{S,\gamma}} f^*(\omega_1 \otimes \dots \otimes \omega_k) .$$

It follows that a product of period integrals on real moduli spaces is itself a period of real moduli spaces.

Remark 7.11. We know that f extends to give a map $\mathfrak{M}_{0,S}^\delta \longrightarrow \prod_{i=1}^k \mathfrak{M}_{0,T_i}^{\delta_i}$. The previous corollary therefore implies the following multiplication formula for the framed mixed Tate motives defined in §7.2:

$$(7.22) \quad \bigotimes_{i=1}^k m_{T_i,\delta_i}(\omega_i) = \bigoplus_{\gamma \in G_f} m_{S,\gamma}(f^*(\omega_1 \otimes \dots \otimes \omega_k)) .$$

We can apply the product formula above to the set of multiple zeta forms $\Omega(\underline{\epsilon})$ defined in §7.4. As in §5.5, let X denote an alphabet with two letters $\{x_0, x_1\}$. Let $w = x_{\epsilon_m} \dots x_{\epsilon_1}$ and $w' = x_{\epsilon_\ell} \dots x_{\epsilon_{m+1}}$ denote two words in $x_0 X^* x_1$, where $\epsilon_i \in \{0, 1\}$, such that $\epsilon_1 = \epsilon_{m+1} = 1$ and $\epsilon_m = \epsilon_\ell = 0$. Let us write $\underline{\epsilon} = (\epsilon_1, \dots, \epsilon_m)$ and $\underline{\epsilon}' = (\epsilon_{m+1}, \dots, \epsilon_\ell)$. Recall the simplicial product map defined in §2.7:

$$m_\Delta : \mathfrak{M}_{0,S} \longrightarrow \mathfrak{M}_{0,S_1} \times \mathfrak{M}_{0,S_2} ,$$

where $S_1 = \{s_1, s_2, \dots, s_{m+3}\}$ and $S_2 = \{s_1, s_2, s_3, s_{m+4}, \dots, s_n\}$. We deduce that

$$\int_{X_{S_1,\delta_1}} \Omega(\underline{\epsilon}) \int_{X_{S_2,\delta_2}} \Omega(\underline{\epsilon}') = \sum_{\gamma \in G_{m_\Delta}} \int_{X_{S,\gamma}} m_\Delta^*(\Omega(\underline{\epsilon}) \otimes \Omega(\underline{\epsilon}')) .$$

Recall from §2.7 that G_{m_Δ} is the set of $(m, \ell - m)$ -shuffles, and that, in simplicial coordinates, $X_{S, \delta}$ is the unit simplex. We therefore deduce that

$$\begin{aligned} & \int_{0 < t_1 < \dots < t_m < 1} \bigwedge_{i=1}^m \frac{dt_i}{\epsilon_i - t_i} \times \int_{0 < t_{m+1} < \dots < t_\ell < 1} \bigwedge_{i=m+1}^{\ell} \frac{dt_i}{\epsilon_i - t_i} \\ &= \sum_{\sigma \in \mathfrak{S}(m, \ell - m)} \int_{0 < t_{\sigma(1)} < \dots < t_{\sigma(\ell)} < 1} \bigwedge_{i=1}^{\ell} \frac{dt_i}{\epsilon_i - t_i}, \end{aligned}$$

which, by (7.19), gives the shuffle product formula:

$$(7.23) \quad \zeta(w) \zeta(w') = \sum_{\sigma \in \mathfrak{S}(m, \ell - m)} \zeta(x_{\sigma(\epsilon_\ell)} x_{\sigma(\epsilon_{\ell-1})} \dots x_{\sigma(\epsilon_1)}) = \zeta(w \amalg w').$$

Now let us see what happens in the case of the cubical product map (2.48):

$$m_\square : \mathfrak{M}_{0, S} \longrightarrow \mathfrak{M}_{0, S_1} \times \mathfrak{M}_{0, S_2},$$

where $S_1 = \{s_2, s_3, \dots, s_{m+4}\}$ and $S_2 = \{s_{m+4}, \dots, s_n, s_1, s_2, s_3\}$. We deduce that

$$\int_{X_{S_1, \delta_1}} \Omega(\underline{\epsilon}) \int_{X_{S_2, \delta_2}} \Omega(\underline{\epsilon}') = \int_{X_{S, \delta}} m_\square^* (\Omega(\underline{\epsilon}) \otimes \Omega(\underline{\epsilon}')),$$

since in this case G_{m_\square} is the single element $\{\delta\}$. In cubical coordinates, each fundamental cell is a hypercube, and thus we obtain the formula:

$$(7.24) \quad \int_{[0,1]^m} \Omega_c(\underline{\epsilon}) \int_{[0,1]^{\ell-m}} \Omega_c(\underline{\epsilon}') = \int_{[0,1]^\ell} \Omega_c(\underline{\epsilon}) \Omega_c(\underline{\epsilon}'),$$

where

$$(7.25) \quad \Omega_c(\epsilon_1, \dots, \epsilon_m) = \bigwedge_{i=1}^m \frac{d(x_i \dots x_\ell)}{\epsilon_i - x_i \dots x_\ell}.$$

One can write the product $\Omega_c(\underline{\epsilon}) \Omega_c(\underline{\epsilon}')$ as a sum of terms $\Omega_c(\underline{\epsilon}'')$ either using an identity due to Cartier (see [Zu]) or using a power series expansion due to Goncharov ([Go3], lemma 9.6). We use the latter approach. Let $\eta_i = (1, 0, \dots, 0)$ denote a 1 followed by a sequence $i - 1$ zeros. Then

$$\Omega_c(\epsilon_1, \dots, \epsilon_m) = \Omega_c(\eta_{m_1}, \dots, \eta_{m_r}) = \sum_{0 \leq k_1 < \dots < k_r} y_1^{k_1} \dots y_r^{k_r} dx_1 \dots dx_m,$$

where $y_1 = x_1 \dots x_{n_1}$, $y_2 = x_{n_1+1} \dots x_{n_2}$, \dots , $y_r = x_{n_{r-1}+1} \dots x_{n_r}$. Expanding $\Omega_c(\underline{\epsilon}')$ in a similar way, we obtain

$$\begin{aligned} \Omega_c(\underline{\epsilon}) \Omega_c(\underline{\epsilon}') &= \sum_{0 \leq k_1 < \dots < k_r} y_1^{k_1} \dots y_r^{k_r} \sum_{0 \leq k_{r+1} < \dots < k_t} y_{r+1}^{k_{r+1}} \dots y_t^{k_t} dx_1 \dots dx_\ell \\ &= \sum_{\sigma \in \overline{\Sigma}_{m, \ell - m}} \sum_{\sigma_*(k_1, \dots, k_t)} y_1^{k_1} \dots y_t^{k_t} dx_1 \dots dx_\ell = \sum_{\sigma \in \overline{\Sigma}_{m, \ell - m}} \Omega_c(\sigma(\underline{\epsilon}, \underline{\epsilon}')), \end{aligned}$$

where $\overline{\Sigma}_{m, \ell - m}$ is the set of stuffles in the stuffle product for quasi-symmetric power series [Ho], and $\sigma_*(k_1, \dots, k_t)$ is the corresponding domain of summation. Substituting this into (7.24), we deduce the stuffle product formula (see [W]):

$$(7.26) \quad \zeta(w) \zeta(w') = \zeta(w \star w').$$

Remark 7.12. This approach can be used to derive any number of elementary products between multiple zeta values. To make such a product explicit, one needs to fix a rule for decomposing a product of ℓ -forms into a sum of ℓ -forms of a preferred type (for example, $\Omega(\underline{\varepsilon})$ or $\Omega_c(\underline{\varepsilon})$). The motivic origin of such a product formula follows immediately from remark 7.11 above (in the case of the shuffle and stuffle formulae, this is equivalent to an argument due to Goncharov [Go3]). We see by looking at the sets G_{m_\square} and G_{m_Δ} , that the shuffle and stuffle product formulae are extreme cases of a range of intermediary product formulae, obtained by shuffling together two subsets of $\{s_3, \dots, s_\ell\}$ relative to $s_1 = 1$, $s_2 = \infty$, and $s_3 = 0$. Such modular products will be studied elsewhere.

7.6. Product formulae for integrals of generalised polylogarithms. More generally, we can apply the product formulae to convergent iterated integrals of functions of arbitrary weight, rather than just regular algebraic forms. If f is a non-degenerate coordinate system (§2.7), there is a commutative diagram

$$\begin{array}{ccc} f^* : \bigotimes_{i=1}^k B(\mathfrak{M}_{0,T_i}) & \longrightarrow & B(\mathfrak{M}_{0,S}) \\ & \downarrow & \downarrow \\ \bigotimes_{i=1}^k L^{v_i, \delta_i}(\mathfrak{M}_{0,T_i}) & \longrightarrow & L^{v, \delta}(\mathfrak{M}_{0,S}) , \end{array}$$

where f^* is a map of differential graded algebras. The vertices v, v_1, \dots, v_k are chosen such that $f(v) = (v_1, \dots, v_k) \in \prod_{i=1}^k \mathfrak{M}_{0,T_i}^{\delta_i}$. The vertical maps are given by canonical regularisation maps $\rho_{v, \delta}, \rho_{v_i, \delta_i}$ defined in §6.7. Since each $B(\mathfrak{M}_{0,T_i})$ is differentially simple, and since the map $f_{T_i}^*$ is non-zero for each $1 \leq i \leq k$, it follows that f^* is injective. The horizontal map along the bottom is given by composition and multiplication of functions:

$$(p_1, \dots, p_k) \mapsto p_1 \circ f_{T_1} \times \dots \times p_k \circ f_{T_k} .$$

In the same way as §7.5, we deduce the product formula:

$$(7.27) \quad \prod_{i=1}^k \int_{\overline{X}_{T_i, \delta_i}} p_i = \sum_{\gamma \in G_f} \int_{X_{S, \gamma}} \prod_{i=1}^k p_i \circ f_{T_i} ,$$

where we suppose that all integrals are convergent. In this way, we can obtain product formulae for generalised period integrals (integrals of polylogarithms).

In §6.6 we defined an action of the dihedral group of symmetries on the space of functions $L_{\mathbb{Z}}^{\delta}(\mathfrak{M}_{0,S})$. We therefore have the following formula for any function $f \in L^{v, \delta}(\mathfrak{M}_{0,S})$ such that the integral converges:

$$(7.28) \quad \int_{\overline{X}_{S, \delta}} f = \int_{\overline{X}_{S, \delta}} \sigma^* f \quad \text{for all } \sigma \in D_{2n} .$$

If we combine dihedral symmetries with such product formulae, we have much freedom for manipulating integrals of generalised polylogarithms over $\overline{X}_{S, \delta}$. In particular, we can replace a period integral over any given face of the Stasheff polytope $\overline{X}_{S, \delta}$ with one over a face of fixed combinatorial type.

Lemma 7.13. *Let $F_0 \subset \partial \overline{X}_{S, \delta}$ denote a fixed face of the Stasheff polytope $\overline{X}_{S, \delta}$ which corresponds to a short chord $\{i, i+1\}$ in the n -gon (S, δ) . Given any other face $F \subset \partial \overline{X}_{S, \delta}$, and any form $\omega \in \Omega^{\ell-1} L_{\mathbb{Z}}^{\delta|F}(F)$, there exists another form $\omega' \in$*

$\Omega^{\ell-1} L_{\mathcal{Z}}^{\delta|_{F_0}}(F_0)$ such that

$$\int_F \omega = \int_{F_0} \omega' ,$$

where the weight of ω is less than or equal to the weight of ω' .

Proof. By using a product (7.27) we can replace the integral of ω over $F \cong \overline{X}_{k,\delta_1} \times \overline{X}_{n-1-k,\delta_2}$ with an integral over a face of $\partial \overline{X}_{S,\delta}$ of combinatorial type $\overline{X}_{n-1,\delta'}$. Since the group of dihedral symmetries D_{2n} acts transitively on the set of all such faces, we can replace this with an integral over the face F_0 by applying (7.28). \square

7.7. Examples of period integrals in small dimensions. First of all, consider the case $\mathfrak{M}_{0,S}^{\delta}(\mathbb{R})$, where $S = \{s_1, \dots, s_5\}$, with the obvious dihedral structure which we denote δ . We shall work in cubical coordinates (x_1, x_2) , which we write (x, y) . The set of chords $\chi_{S,\delta}$ is $\{13, 24, 35, 41, 52\}$, and the dihedral coordinates are

$$(7.29) \quad u_{13} = 1 - xy, \quad u_{24} = x, \quad u_{35} = \frac{1-x}{1-xy}, \quad u_{41} = \frac{1-y}{1-xy}, \quad u_{52} = y .$$

The domain $\overline{X}_{S,\delta}$ is bounded by the five sets of equations $u_{ij} = 0$, $u_{i+1j+1} = u_{i-1j-1} = 1$ for each pair $\{i, j\} \in \chi_{S,\delta}$, and these form the sides of a pentagon whose interior is $X_{S,\delta}$. In all, there are ten stable partitions of the set $\{s_1, \dots, s_5\}$, which means that there are another five divisors at infinity given by the five equations $u_{ij} = \infty$, $u_{i-2j-2} = u_{i+2j+2} = 0$, where $\{i, j\} \in S$. These too form a pentagon.

The volume form $\omega_{S,\delta} = d \log u_{13} \wedge d \log u_{24} = (1-xy)^{-1} dx dy$, and every real period integral on $\overline{X}_{S,\delta}$ is a sum of integrals

$$I_{\chi_{S,\delta}}(\alpha_{ij}) = \int_{X_{S,\delta}} u_{13}^{\alpha_{13}} u_{24}^{\alpha_{24}} u_{35}^{\alpha_{35}} u_{41}^{\alpha_{41}} u_{52}^{\alpha_{52}} \omega_{S,\delta} ,$$

which in cubical coordinates is just

$$I_5(h, i, j, k, l) = \int_0^1 \int_0^1 \frac{x^h (1-x)^i y^k (1-y)^j}{(1-xy)^{i+j-l}} \frac{dx dy}{1-xy} ,$$

where we have set $\alpha_{24} = h$, $\alpha_{35} = i$, $\alpha_{41} = j$, $\alpha_{52} = k$, $\alpha_{13} = l$. This exactly coincides with the family of integrals first defined by Dixon, and studied by Rhin and Viola [Di, RV1]. The dihedral group D_{10} preserves the integral and permutes the indices $\{h, i, j, k, l\}$. It is generated by a cyclic rotation of order five τ_5 , and a reflection of order two σ_5 , where

$$\tau_5(x, y) = \left(1 - xy, \frac{1-y}{1-xy}\right) , \quad \sigma_5(x, y) = (y, x) .$$

Remark 7.14. By combining the action of the dihedral symmetry group D_{12} on $\mathfrak{M}_{0,6}$ and the product formula for integrals on $\mathfrak{M}_{0,4} \times \mathfrak{M}_{0,5}$ one can deduce the ‘hypergeometric transformation formula’ for the integrals above. This remarkable identity was discovered by Dixon in 1905, and was exploited by Rhin and Viola to obtain the best irrationality measures for $\zeta(2)$ known to date. It is:

$$(7.30) \quad \frac{1}{j! k!} I(h, i, j, k, l) = \frac{1}{(k+l-i)!(i+j-l)!} I(h, i, k+l-i, i+j-l, l) .$$

Before proving this identity, first observe that the real period integral I_4 on $\mathfrak{M}_{0,4}$ is the following beta integral:

$$(7.31) \quad I_4(\alpha_{13}, \alpha_{24}) = \int_0^1 x^{\alpha_{24}} (1-x)^{\alpha_{13}} dx = \frac{\alpha_{13}! \alpha_{24}!}{(\alpha_{13} + \alpha_{24} + 1)!} \in \mathbb{Q}.$$

Now consider the case $\mathfrak{M}_{0,6}$. In cubical coordinates $(x, y, z) = (x_1, x_2, x_3)$ we have:

$$(7.32) \quad u_{13} = 1 - xyz, \quad u_{24} = x, \quad u_{35} = \frac{1-x}{1-xy}, \quad u_{46} = \frac{(1-xyz)(1-y)}{(1-xy)(1-yz)}, \quad u_{51} = \frac{1-z}{1-yz}, \quad u_{62} = z,$$

$$u_{14} = \frac{1-yz}{1-xyz}, \quad u_{25} = y, \quad u_{36} = \frac{1-xy}{1-xyz}.$$

Let $h, i, j, k, l, m, r, s, t$ be any nine non-negative integers. Let $I_6(h, i, j, k, l, m; r, s, t)$ denote the period integral of weight three on $\mathfrak{M}_{0,6}$ which is therefore given by

$$(7.33) \quad \int_0^1 \int_0^1 \int_0^1 \frac{x^h (1-x)^i y^t (1-y)^j z^l (1-z)^k}{(1-xy)^{i+j-r} (1-yz)^{j+k-s} (1-xyz)^{r+s-j-m}} \frac{dx dy dz}{(1-xy)(1-yz)}.$$

The dihedral group of symmetries D_{12} for $\mathfrak{M}_{0,6}$ is generated by a cyclic permutation we denote $\tau_6 = (h i j k l m)(r s t)$, and the reflection $\sigma_6 = (h l)(i k)(r s)$. In the degenerate case where $r + s = j + m$ and $r = i + j + 1$, the terms $(1 - xy)$ and $(1 - xyz)$ vanish in the integrand and (7.33) splits as a product $I_4(h, i) I_5(l, k, j, t, s)$. This is precisely a cubical product. Similarly, if the terms $(1 - yz)$ and $(1 - xyz)$ vanish, then we obtain a different splitting of the integral.

Proof of (7.30). Let h, i, j, k, l be non-negative integers. We can assume without loss of generality that $i < l$. Set $\alpha = k + l - i$, and $\beta = i - l - 1$. Consider

$$I_4(\alpha, \beta) I_5(h, i, j, k, l) = I_6(h, i, j, \beta, \alpha, l + \beta + 1; l, j + \beta + 1, k).$$

We apply the cyclic permutation τ_6^4 and use the fact that $\alpha + \beta + 1 = k$, $\alpha + i = k + l$ to obtain a different splitting. This gives

$$I_6(j, \beta, \alpha, l + \beta + 1, h, i; k, l, j + \beta + 1) = I_4(j, \beta) I_5(h, l + \beta + 1, \alpha, j + \beta + 1, l).$$

Replacing the I_4 terms with factorials using (7.31), we obtain the identity (7.30).

These examples illustrate how many important identities between multiple zeta values and Euler integrals can be proved by simple geometric considerations on moduli spaces $\mathfrak{M}_{0,n}$. Kontsevich and Zagier have made the very general and ambitious conjecture that every identity between periods can be proved using three elementary operations on integrals: changes of variables, the linearity of integration, and Stokes' theorem. In our situation, we have an infinite family of period integrals, but we have a fixed set of algebraic operations which we can perform on these integrals (*e.g.*, the action of dihedral symmetries and the multiplication rules we defined above). It would be interesting to see which of the many known identities between multiple zeta values can be proved by using just these operations.

8. CALCULATION OF THE PERIODS OF $\mathfrak{M}_{0,n}$.

We prove that the integral of a convergent algebraic ℓ -form over an associahedron $X_{S,\delta}$ can be written as a linear combination of multiple zeta values of weight at most ℓ . The key to the argument is the interplay between logarithmic singularities (which are permitted), and polar singularities (which are forbidden), along the boundaries of the associahedron $\overline{X}_{S,\delta}$.

8.1. Pole-free primitives. In order to apply Stokes' theorem to the manifold with corners $\overline{X}_{S,\delta}$, we need to verify that the algebra of generalised polylogarithms on $\mathfrak{M}_{0,S}^\delta$ satisfies the required properties.

First of all, it follows from the regularization results of §6.7 that the coefficients of the generating series of generalized polylogarithms $L_{v,\delta}(z)$ have at most logarithmic singularities along the boundary of the Stasheff polytope $\overline{X}_{S,\delta}$. This implies that

$$(8.1) \quad L_{\mathcal{Z}}^\delta(\mathfrak{M}_{0,S}) \subset \Gamma(\overline{X}_{S,\delta}, \mathcal{F}_p^{\log}).$$

Theorem 6.26 tells us that primitives exist in $L_{\mathcal{Z}}^\delta(\mathfrak{M}_{0,S})$. One difficulty, however, is that primitives of n -forms on a manifold of dimension n are not unique, and we may inadvertently introduce extra poles, which would give rise to divergent integrals. We show how to remove these extra poles below. In order to do this, we define

$$(8.2) \quad L_{\mathcal{Z}}^{\delta,+}(\mathfrak{M}_{0,S}) = L_{\mathcal{Z}}^\delta(\mathfrak{M}_{0,S}) \cap \Gamma(\overline{X}_{S,\delta}, \mathcal{F}^{\log})$$

to be the sub-algebra of polylogarithms on $\mathfrak{M}_{0,S}$ which have at most logarithmic singularities on the boundary faces of the Stasheff polytope $\overline{X}_{S,\delta}$. Observe that every generalised polylogarithm has a canonical branch on $X_{S,\delta}$, and is therefore a well-defined, real-valued function.

Proposition 8.1. *Let $f \in W^k \Omega^\ell L_{\mathcal{Z}}^{\delta,+}(\mathfrak{M}_{0,S})$. There exists a pole-free primitive*

$$F \in W^{k+1}(\Omega^{\ell-1} L_{\mathcal{Z}}^{\delta,+}(\mathfrak{M}_{0,S}))$$

such that $dF = f$, which implies that the restriction of F to $\partial\overline{X}_{S,\delta}$ is continuous. In other words, the conditions of theorem 4.11 hold.

Proof. We know from theorem 6.26 that $L_{\mathcal{Z}}^\delta(\mathfrak{M}_{0,S})$ has trivial de Rham cohomology. It follows that we can find a primitive $G \in \Omega^{\ell-1} L_{\mathcal{Z}}^\delta(\mathfrak{M}_{0,S})$ for f , of weight at most $k+1$, which may have polar singularities along $\partial\overline{X}_{S,\delta}$.

In order to remove spurious poles in G , we work on a single chart of $\overline{X}_{S,\delta}$ at a time. Therefore, let $e \in \chi_{S,\delta}^q$ denote a partial decomposition of the n -gon (S, δ) , and let $\alpha \in \chi_{S,\delta}^\ell$ be a full triangulation which contains e . For every small $\varepsilon > 0$, recall that there is a chart $U_e(\varepsilon)$ (see (4.2)), which has local (vertex) coordinates $x_1^\alpha, \dots, x_\ell^\alpha$, which are canonical up to permutations. Recall that $U_e(\varepsilon) \cong U_{p,q}$ where $p+q = \ell$ (§4). It contains the face $F_e = \{u_{ij} = 0 : \{i, j\} \in e\}$, and we can assume, by reordering the coordinates if necessary, that $F_e = \{x_1^\alpha = \dots = x_q^\alpha = 0\}$. We remove polar singularities with respect to each coordinate $x_1^\alpha, \dots, x_q^\alpha$ in turn. First, there is a decomposition $G = G_p + G'$, where G' has at most logarithmic singularities in x_1^α , and G_p is the divergent part of G along $\{x_1^\alpha = 0\}$:

$$G_p = \sum_{a \geq 0, b \geq 1} \frac{\log^a x_1^\alpha}{(x_1^\alpha)^b} g_{a,b}(x_2^\alpha, \dots, x_\ell^\alpha) \omega_{a,b} + \sum_{c \geq 1} \log^c x_1^\alpha h_c(x_2^\alpha, \dots, x_\ell^\alpha) dx_2^\alpha \dots dx_\ell^\alpha,$$

where $g_{a,b}(x_2^\alpha, \dots, x_\ell^\alpha), h_c(x_2^\alpha, \dots, x_\ell^\alpha) \in \mathcal{F}_p^{\text{log}}(U_{p,q-1})$, and where $\omega_{a,b}$ are any $\ell - 1$ forms $\sum_i a_i dx_1^\alpha \dots \widehat{dx_i^\alpha} \dots dx_\ell^\alpha$, where $a_i \in \mathbb{R}$. By differentiating this expression, and using the fact that $dG = f$ has no poles, it is easy to verify that $dG_p = 0$ (in other words, poles can only get worse on differentiating). Therefore $dG' = f$, and so G' is a primitive of f which has no poles along $x_1^\alpha = 0$. Using the fact that $L_{\mathcal{Z}}^\delta(\mathfrak{M}_{0,S})$ is closed under differentiation with respect to x_i^α , and closed under taking regularised limits at $x_i^\alpha = 0$, for $1 \leq i \leq \ell$ (theorem 6.25), one can easily check that G' lies in $L_{\mathcal{Z}}^\delta(\mathfrak{M}_{0,S})$, *i.e.*, G' is still a generalised polylogarithm. Repeating this argument for $x_1^\alpha, \dots, x_q^\alpha$, in turn, we obtain a primitive of f with no poles on the local chart $U_2(\varepsilon)$. The whole argument can then be repeated on each local chart of $X_{S,\delta}$, and we end up with a primitive F of f which has no poles anywhere along $\partial\overline{X}_{S,\delta}$. This is because, whenever we remove a polar singularity along the divisor D_{ij} , $\{i,j\} \in \chi_{S,\delta}$, no new poles are created along any other boundary component D_{kl} , where $\{k,l\} \in \chi_{S,\delta}$, and the total weight is not increased. This proves the proposition. The fact that the restriction of F to each component of the boundary is continuous follows from lemma 4.10. \square

In §8.3 we show how to construct canonical primitives which are automatically free of poles along $\partial\overline{X}_{S,\delta}$.

8.2. Proof of the main theorem. Let S denote a set of order $n = \ell + 3$ with a fixed dihedral structure δ .

Theorem 8.2. *For all sets of indices $\alpha_{ij} \geq 0$,*

$$I_{S,\delta}(\alpha_{ij}) = \int_{\overline{X}_{S,\delta}} \prod_{\{i,j\} \in \chi_{S,\delta}} u_{ij}^{\alpha_{ij}} \omega_{S,\delta} \in W^\ell \mathcal{Z} .$$

Proof. The proof is by induction and by repeated application of Stokes' theorem (theorem 4.11). We write $S = S_n = \{s_1, \dots, s_n\}$. First observe that the regular ℓ -form

$$f_0 = \prod_{\{i,j\} \in \chi_{S,\delta}} u_{ij}^{\alpha_{ij}} \omega_{S,\delta} \in W^0(\Omega^\ell L_{\mathcal{Z}}^\delta(\mathfrak{M}_{0,S}))$$

has no poles on the compact set $\overline{X}_{S,\delta}$. Let us write

$$S_i = \{s_1, \dots, s_i\} \quad \text{for all } 3 \leq i \leq n ,$$

and let δ_b denote the dihedral structure on $S_b \subset S$ induced by δ . This is equivalent to choosing a nested sequence of sub-faces of $\overline{X}_{S,\delta}$ in its stratification. Let $0 \leq b \leq \ell$, and suppose by induction that there exists an $\ell - b$ form

$$f_b \in W^b(\Omega^{\ell-b} L_{\mathcal{Z}}^{\delta,+}(\mathfrak{M}_{0,S_{n-b}})) ,$$

which has no poles on $\overline{X}_{S_{n-b},\delta_{n-b}}$, such that

$$I_{S,\delta}(\alpha_{ij}) = \int_{\overline{X}_{S_{n-b},\delta_{n-b}}} f_b .$$

By proposition 8.1, there exists a primitive $P \in \Omega^{\ell-b-1} L_{\mathcal{Z}}^{\delta,+}(\mathfrak{M}_{0,S_{n-b}})$ of weight at most $b + 1$, which has no poles in $\overline{X}_{S_{n-b},\delta_{n-b}}$, and is continuous on the interior of $\partial\overline{X}_{S_{n-b},\delta_{n-b}}$. By the version of Stokes' formula stated in theorem 4.11,

$$I_{S,\delta}(\alpha_{ij}) = \int_{\overline{X}_{S_{n-b},\delta_{n-b}}} f_b = \int_{\partial\overline{X}_{S_{n-b},\delta_{n-b}}} P .$$

By the geometry of the Stasheff polytopes (§2.2), we know that

$$\partial \overline{X}_{S_{n-b}, \delta_{n-b}} = \bigcup_{\{i,j\} \in \chi_{S_{n-b}, \delta_{n-b}}} F_{ij} ,$$

where $F_{ij} = F_{ij}(\overline{X}_{S_{n-b}, \delta_{n-b}})$ is the face corresponding to the chord $\{i, j\}$, and therefore

$$(8.3) \quad I_{S, \delta}(\alpha_{ij}) = \sum_{\{i,j\} \in \chi_{S_{n-b}, \delta_{n-b}}} \int_{F_{ij}} P|_{F_{ij}} .$$

Given a chord $\{i, j\} \in \chi_{S_{n-b}, \delta_{n-b}}$, there exists a partition of $S_{n-b} = T_1 \cup T_2$ such that $F_{ij} \cong \overline{X}_{T_1 \cup \{e\}, \delta_1} \times \overline{X}_{T_2 \cup \{e\}, \delta_2}$, where e corresponds to the chord $\{i, j\}$ (equation (2.35)) and δ_1, δ_2 are the induced dihedral structures. By theorem 6.25, we have

$$P|_{F_{ij}} \in W^{b+1} \Omega^{\ell-b-1} (L_{\mathbb{Z}}^{\delta_1}(\mathfrak{M}_{0, T_1 \cup \{e\}}) \otimes L_{\mathbb{Z}}^{\delta_2}(\mathfrak{M}_{0, T_2 \cup \{e\}})) .$$

By lemma 7.13, there exists $g_{ij} \in W^{b+1}(\Omega^{\ell-b-1} L_{\mathbb{Z}}^{\delta}(\mathfrak{M}_{0, S_{n-b-1}}))$ such that

$$\int_{\overline{X}_{T_1 \cup \{e\}, \delta_1} \times \overline{X}_{T_2 \cup \{e\}, \delta_2}} P|_{F_{ij}} = \int_{\overline{X}_{S_{n-b-1}, \delta_{n-b-1}}} g_{ij} .$$

Thus each integral in the sum (8.3) can be written as an integral over the fixed face $\overline{X}_{S_{n-b-1}, \delta_{n-b-1}}$ by applying product formulae and using dihedral symmetries. Since $P|_{F_{ij}}$ is continuous with at most logarithmic singularities along ∂F_{ij} , it follows that $g_{ij} \in \Omega^{\ell-b-1} (L_{\mathbb{Z}}^{\delta, +}(\mathfrak{M}_{0, S_{n-b-1}}))$. Taking the sum over all $\{i, j\} \in \chi_{S_{n-b-1}, \delta_{n-b-1}}$ in (8.3), we obtain a form $f_{b+1} \in W^{b+1}(\Omega^{\ell-b-1} L_{\mathbb{Z}}^{\delta, +}(\mathfrak{M}_{0, S_{n-b-1}}))$ such that

$$I_{S, \delta}(\alpha_{ij}) = \int_{\overline{X}_{S_{n-b-1}, \delta_{n-b-1}}} f_{b+1} .$$

This completes the induction step. At the final stage of the induction, we deduce that $I_{S, \delta}$ is given by evaluating a multiple polylogarithm in one variable in $W^{\ell} L_{\mathbb{Z}}^{\delta}(\mathfrak{M}_{0, 4})$ at a single point. We conclude (see §5.5) that $I_{S, \delta}(\alpha_{ij}) \in W^{\ell} \mathcal{Z}$. \square

Note that it is not strictly necessary in the course of the above proof to use the product formula (lemma 7.13). This replaces the sum of a product of integrals with a single integral at each stage, and only serves to simplify notations. Lemma 7.4 implies the following result.

Corollary 8.3. *Every relative period integral over a union of cells X_{S, δ_i} can be written as a linear combination of multiple zeta values of weight at most $\dim \mathfrak{M}_{0, S}(\mathbb{R})$.*

8.3. Canonical primitives - an algorithmic approach. The existence of primitives uses the fact that $\mathfrak{M}_{0, S}$ is a fiber-type hyperplane arrangement. By exploiting the hyperlogarithm fibration, we can find canonical primitives, as in remark 3.42, which have no spurious poles. This gives rise to a simplified series of integrals occurring in the proof of theorem 8.2 above, and yields an effective algorithm for computing period integrals on $\mathfrak{M}_{0, S}(\mathbb{R})$ algebraically.

Let $f \in W^b \Omega^{\ell} L_{\mathbb{Z}}^{\delta, +}(\mathfrak{M}_{0, S})$. Working in cubical coordinates, we can write $f = g(x_1, \dots, x_{\ell}) dx_1 \dots dx_{\ell}$, where $g \in L_{\mathbb{Z}}^{\delta, +}(\mathfrak{M}_{0, S})$ is of weight at most b . Recall that by remark 3.42, there exists a primitive $F \in W^{b+1} \Omega^{\ell-1} L_{\mathbb{Z}}^{\delta}(\mathfrak{M}_{0, S})$ such that

$$F = G(x_1, \dots, x_{\ell}) dx_1 \dots dx_{\ell-1} ,$$

where $\partial G/\partial x_\ell = g$. More concretely, let $S = \{s_1, \dots, s_n\}$ and let $S' = \{s_2, \dots, s_n\}$. Recall from §6.7 that the hyperlogarithm fibration given by projection onto $x_\ell = 0$:

$$\mathfrak{M}_{0,S} \longrightarrow \mathfrak{M}_{0,S'} ,$$

gives rise to a decomposition of filtered algebras

$$L_{\mathcal{Z}}^\delta(\mathfrak{M}_{0,S}) \cong L_{\mathfrak{M}_{0,S'}}(\mathbb{P}^1 \setminus \Sigma) \otimes_{\mathcal{O}(\mathfrak{M}_{0,S'})} L_{\mathcal{Z}}^{\delta'}(\mathfrak{M}_{0,S'}) ,$$

where $\Sigma = \{0, 1, x_{\ell-1}^{-1}, \dots, (x_1 \dots x_{\ell-1})^{-1}\}$ as in §5.4, and δ' is the induced dihedral structure on S' . We can therefore write the function g as a finite sum of products

$$g(x_1, \dots, x_\ell) = \sum_i a_i(x_\ell) b_i(x_1, \dots, x_{\ell-1}) ,$$

where each $b_i \in L_{\mathcal{Z}}^{\delta'}(\mathfrak{M}_{0,S'})$ is a function of $\ell - 1$ variables $x_1, \dots, x_{\ell-1}$ only, and each a_i , considered as a function of the single variable x_ℓ , is a hyperlogarithm with singularities in $\Sigma \cup \infty$. We can assume that the a_i are linearly independent. The weight of each product of $a_i(x_\ell)$ and $b_i(x_1, \dots, x_{\ell-1})$ is at most b . Now by proposition 3.22, each function $a_i(x_\ell)$ has a primitive (with respect to the variable x_ℓ) which we denote

$$A_i(x_\ell) \in L_{\mathfrak{M}_{0,S'}}(\mathbb{P}^1 \setminus \Sigma) ,$$

which is of weight at most one more than the weight of $a_i(x_\ell)$. We can choose the constant of integration in such a way that $A_i(x_\ell)$ either vanishes at 0, or is $\log^k(x_\ell)$ for some $k \geq 1$ (see §5.2). In the latter case, $a_i(x_\ell)$, and hence $g(x_1, \dots, x_\ell)$ would have a pole at the origin, so this cannot occur (this is precisely the argument in the proof of lemma 4.10). It follows that the function

$$F = \sum_i A_i(x_\ell) b_i(x_1, \dots, x_{\ell-1}) dx_1 \dots dx_{\ell-1}$$

is a primitive of f , and is identically zero on all faces of $\overline{X}_{S,\delta}$ except the single face given by $x_\ell = 1$. The primitive F has no poles since this would contradict the convergence of the integral by lemma 4.9. It is therefore continuous on the interior of this face, and we can apply Stokes' theorem directly. This approach to the induction step in the proof of the main theorem has the advantage that it does not involve any regularisation, or having to apply a product formula (lemma 7.13).

8.4. Taylor expansions of Selberg integrals and multi-beta functions. The method of proof of theorem 8.2 works much more generally, and enables us to compute integrals of arbitrary generalised polylogarithms on $\mathfrak{M}_{0,S}$, which are allowed logarithmic singularities along the boundary of the domain of integration.

Theorem 8.4. *Let $f \in W^k L_{\mathcal{Z}}^{\delta,+}(\mathfrak{M}_{0,S})$ denote a generalised polylogarithm on $\mathfrak{M}_{0,S}$ of weight at most k , which has no poles along $\partial \overline{X}_{S,\delta}$. Then*

$$I(f) = \int_{\overline{X}_{S,\delta}} f \omega_{S,\delta} \in W^{\ell+k} \mathcal{Z} .$$

The proof is identical to the proof of theorem 8.2. Note that the integrand is always well-defined on the real domain $X_{S,\delta}$ at each stage of the induction. If we apply this theorem in the case where f is of weight at most one, *i.e.*, a $\mathcal{O}(\mathfrak{M}_{0,S})$ -linear combination of logarithms, then we deduce the following corollary.

Corollary 8.5. *Let $\{s_{ij}\}$ denote a set of complex parameters. It follows from the calculations in §4 that the following integral, viewed as a function of the variables s_{ij} , is holomorphic in the region $\operatorname{Re} s_{ij} > -1$:*

$$(8.4) \quad \beta_{S,\delta}(\{s_{ij}\}) = \int_{\overline{X}_{S,\delta}} \prod_{\{i,j\} \in \chi_{S,\delta}} u_{ij}^{s_{ij}} \omega_{S,\delta} .$$

The coefficients of its Taylor expansion (with respect to the variables s_{ij}) at any integral point $s_{ij} \in \mathbb{Z}$, where $s_{ij} \geq 0$ for all $\{i,j\} \in \chi_{S,\delta}$, are multiple zeta values.

Similar kinds of results have been obtained by Terasoma [Ter] in certain cases. The integral (8.4) defines a multi-beta function, since in the case $\mathfrak{M}_{0,4}$ it reduces to the ordinary beta function. It satisfies many functional identities coming from the dihedral relations (2.10), the product maps (7.27), and also the action of the dihedral symmetry group, and would merit further study.

8.5. Computation of all relative periods of the moduli spaces $\mathfrak{M}_{0,S}$. Let A, B denote two sets of divisors in $\overline{\mathfrak{M}}_{0,S} \setminus \mathfrak{M}_{0,S}$ which do not share any irreducible components (§7.2). We sketch a proof of the following result.

Theorem 8.6. *The periods of $H^\ell(\overline{\mathfrak{M}}_{0,S} \setminus A, B \setminus B \cap A)$ are \mathbb{Q} -linear combinations of multiple zeta values and the constant $2i\pi$, of total weight at most ℓ .*

Let $\Delta_B \subset \mathfrak{M}_{0,S}(\mathbb{C})$ denote any real smooth compact submanifold with corners of dimension ℓ , whose boundary is contained in the set of complex points of B . Let $\omega \in \Omega^\ell(\overline{\mathfrak{M}}_{0,S} \setminus A)$. We can assume that Δ_B is disjoint from A , and that Δ_B is stratified by B according to (7.11). Let A be a union of distinct divisors A_i , for $1 \leq i \leq N$.

By decomposing the relative homology class $[\Delta_B] \in H_\ell(\overline{\mathfrak{M}}_{0,S} \setminus A, B \setminus B \cap A)$ into different pieces, we can first consider the case when Δ_B does not wind non-trivially around any component A_i of A . In this case, write $X = \Delta_B$, and observe that the argument given in §8.2 goes through as before. In other words, we can take primitives in the algebra of polylogarithms $L_{\mathcal{Z}}^\delta(\mathfrak{M}_{0,S})$, and repeatedly apply Stokes' formula (theorem 4.11) to the manifold with corners X , and proceed by induction. Note that, although X is not necessarily simply-connected, the argument goes through as long as the functions we integrate remain single-valued along X . Since X does not wind around A , we can always ensure that this is the case, by taking primitives whose singularities are contained in A . This proves that

$$\int_X \omega \in W^\ell \mathcal{Z} .$$

In the case when Δ_B winds around some component of A , we apply a residue formula and induction. To make this precise, let $A_i^c = \bigcup_{j \neq i} A_j$ for all $1 \leq i \leq N$, and consider the residue map

$$H^\ell(\overline{\mathfrak{M}}_{0,S} \setminus A, B \setminus B \cap A) \longrightarrow \bigoplus_{i=1}^N H^{\ell-1}(A_i \setminus (A_i \cap A_i^c), (B \cap A_i) \setminus (B \cap A_i \cap A_i^c)) ,$$

and its dual map

$$H_\ell(\overline{\mathfrak{M}}_{0,S} \setminus A, B \setminus B \cap A) \longleftarrow \bigoplus_{i=1}^N H_{\ell-1}(A_i \setminus (A_i \cap A_i^c), (B \cap A_i) \setminus (B \cap A_i \cap A_i^c)) .$$

Suppose that $[\Delta_B] \in H_\ell(\overline{\mathfrak{M}}_{0,S} \setminus A, B \setminus B \cap A)$ is the image of a class $[Y] \in H_{\ell-1}(A_i \setminus (A_i \cap A_i^c), (B \cap A_i) \setminus (B \cap A_i \cap A_i^c))$, for some $1 \leq i \leq N$, where $Y \subset A_i \setminus (A_i \cap A_i^c)$ is a smooth compact submanifold with corners of dimension $\ell - 1$. Therefore Δ_B resembles a narrow tube around A_i . By taking the residue along A_i , we get:

$$\int_{\Delta_B} \omega = 2i\pi \int_Y \text{Res } \omega \Big|_{A_i} .$$

The corresponding period is therefore $2\pi i$ times a period of $H_{\ell-1}(A_i \setminus (A_i \cap A_i^c), (B \cap A_i) \setminus (B \cap A_i \cap A_i^c))$. Since A_i is itself isomorphic to a product of moduli spaces, we can repeat the argument inductively. We conclude that, in all cases,

$$\int_{\Delta_B} \omega \in W^\ell \mathcal{Z}[2i\pi] ,$$

where $\mathcal{Z}[2i\pi]$ has the natural filtration which gives $2i\pi$ weight 1.

8.6. Some simple examples. In the following examples, it is convenient to work in cubical coordinates x_1, \dots, x_ℓ . At each stage we take canonical primitives (as described in §8.3) with respect to x_1 or x_ℓ . This is because the projection maps onto $x_1 = 0$ or $x_\ell = 0$ are fibrations (§2.3), and so we can use the method of partial fractions to find primitives. At each stage, one can re-confirm (using dihedral coordinates) that the primitives have no poles along the boundary of the domain of integration $\overline{X}_{S,\delta}$. First, assume $|S| = 5$, that is $S = \{s_1, \dots, s_5\}$. We compute

$$I_1 = \int_{\overline{X}_{S,\delta}} \omega_{S,\delta} = \int_0^1 \int_0^1 \frac{dx dy}{1 - xy} .$$

Following §8.3, we take the primitive of $\omega_{S,\delta}$ with respect to the variable y . This is

$$F = -\log(1 - xy) \frac{dx}{x} ,$$

which vanishes at $y = 0$ as required. In dihedral coordinates (7.29), this is $F = -\log u_{13} d \log u_{24}$, which has no poles at finite distance. Then

$$\int_{\overline{X}_{S,\delta}} \omega_{S,\delta} = \sum_{\{i,j\} \in \mathcal{X}_{S,\delta}} \int_{D_{ij}} -\log u_{13} d \log u_{24} .$$

The only face on which the form does not vanish is the face D_{14} which is defined by $u_{14} = 0, u_{25} = u_{35} = 1$, which implies that $u_{13} = 1 - u_{24}$ by (2.10). We obtain

$$\int_{\overline{X}_{S,\delta}} \omega_{S,\delta} = \int_0^1 -\log(1 - x) \frac{dx}{x} .$$

Notice that the form $\log(1 - x) dx/x$ is continuous on the interval $[0, 1)$ but has a logarithmic singularity at $x = 1$. It has a unique primitive which vanishes at 0, namely $\text{Li}_2(x)$, which is now bounded at $x = 1$ by lemma 4.10. We conclude that

$$(8.5) \quad I_1 = \int_{\overline{X}_{S,\delta}} \omega_{S,\delta} = \left[\text{Li}_2(x) \right]_0^1 = \zeta(2) .$$

Now let $|S| = 6$. Consider the following integral on $\mathfrak{M}_{0,6}$:

$$I_2 = \int_{0 \leq t_1 \leq t_2 \leq t_3 \leq 1} \frac{dt_1}{1 - t_1} \frac{dt_2}{t_2} \frac{dt_3}{t_3 - t_1} = \int_{[0,1]^3} \frac{dx dy dz}{(1 - xyz)(1 - xy)} = \int_{\overline{X}_{S,\delta}} u_{14} \omega_{S,\delta} .$$

The last formula shows that I converges. Working in cubical coordinates, we have

$$I_2 = \int_{[0,1]^2} \left[\frac{-\log(1-xyz)}{xy} \right]_0^1 \frac{dx dy}{1-xy} = \int_{[0,1]^2} \frac{-\log(1-xy)}{xy} \frac{dx dy}{1-xy} .$$

Using partial fractions with respect to the variable y ,

$$I_2 = \int_{[0,1]^2} \frac{-\log(1-xy)}{xy} - \frac{\log(1-xy)}{1-xy} dx dy = \int_0^1 \frac{1}{z} \left[\text{Li}_2(xy) + \frac{1}{2} \log^2(1-xy) \right]_0^1 dx .$$

We conclude that

$$(8.6) \quad I_2 = \int_0^1 \frac{\text{Li}_2(x)}{x} + \frac{\log^2(1-x)}{2x} dx = \left[\text{Li}_3(x) + \text{Li}_{1,2}(x) \right]_0^1 = \zeta(3) + \zeta(1,2) .$$

At each stage one can verify that the canonical primitives we have used above do not introduce any new poles along the boundary of the associahedron $\partial \overline{X}_{S,\delta}$. For example, the first primitive can be written using (7.32):

$$(8.7) \quad \frac{-\log(1-xyz)}{xy} \frac{dx dy}{1-xy} = -\frac{\log(u_{13})}{u_{24}u_{25}} \omega_{5,\delta} ,$$

where $\omega_{5,\delta} = (1-xy)^{-1} dx dy$ is the pull-back of the canonical 2-form on $D_{26} \subset \mathfrak{M}_{0,S}^\delta$ along the map $(x,y,z) \mapsto (x,y) : \mathfrak{M}_{0,6} \rightarrow \mathfrak{M}_{0,5}$. It has no poles at finite distance by definition (lemma 7.1). Furthermore, we know by (2.10) that $1-u_{13} = u_{24}u_{25}u_{26}$, so (8.7) has no poles along $\overline{X}_{S,\delta}$ as required.

To show how lower weight multiple zeta values can occur, let us also compute

$$I_3 = \int_{0 \leq t_1 \leq t_2 \leq t_3 \leq 1} \frac{dt_1}{1-t_1} \frac{dt_2}{t_3-t_1} \frac{dt_3}{t_3} = \int_{[0,1]^3} \frac{y dx dy dz}{(1-xyz)(1-xy)} = \int_{\overline{X}_{S,\delta}} u_{25} u_{14} \omega_{S,\delta} .$$

By applying a dihedral rotation, and referring to (7.32), this is just:

$$I_3 = \int_{X_{S,\delta}} u_{14}u_{36} \omega_{S,\delta} = \int_{[0,1]^3} \frac{dx dy dz}{(1-xyz)^2} .$$

Integrating with respect to the variable x , we obtain by (8.5):

$$(8.8) \quad I_3 = \int_{[0,1]^2} \left[\frac{1}{1-xyz} \right]_0^1 \frac{dy dz}{yz} = \int_{[0,1]^2} \frac{dy dz}{1-yz} = \zeta(2) .$$

9. APPENDIX

Let M be the complement of an affine hyperplane configuration, as defined in §3, and let F denote its ring of regular functions. In the case where the de Rham cohomology ring $H^*(F)$ only has quadratic relations, we can prove directly that all higher cohomology groups of $B(F)$ vanish.

Theorem 9.1. *Let F be the ring of regular functions on an affine hyperplane arrangement M such that $H^*(F)$ is a quadratic algebra. Then*

$$H_{\text{DR}}^0(B(F)) = k , \quad \text{and} \quad H_{\text{DR}}^i(B(F)) = 0 \quad \text{for all} \quad i \geq 1 .$$

Proof. Let $A \subset \Omega^*(F)$ denote the algebra generated by the 1-forms $\omega_1, \dots, \omega_N \in H^1(F)$, where $\omega_i = d \log \alpha_i$ as defined in §3.2. Let $V_1(F) = \bigoplus_{i=1}^N k \omega_i$. Let T denote the free tensor algebra over V_1 . We can view A as a quotient algebra of T

of the form $A = T/TQT$, where Q consists of finitely many quadratic relations q_1, \dots, q_t of the form

$$(9.1) \quad q_l = \sum_{i,j} \lambda_{ij}^l \omega_i \otimes \omega_j \quad \text{for } 1 \leq l \leq t .$$

Now recall that $\Omega^*(B(F)) = \Omega^*(F) \otimes \bigoplus_{m \geq 0} V_m(F)$. The weight filtration on $\Omega^*(B(F))$, defined by $W_m \Omega^i B(F) = \Omega^i(F) \otimes \bigoplus_{j=0}^m V_j(F)$, gives rise to a spectral sequence with E_0 terms

$$E_0^{p,q}(B(F)) = \Omega^{p+q}(F) \otimes V_p(F) ,$$

which is bounded below and exhaustive, and therefore converges to the cohomology of $B(F)$. Consider the differential subalgebra $A(F) = A \otimes \bigoplus_{m \geq 0} V_m(F)$ of $\Omega^*(B(F))$. It also defines a spectral sequence with E_1 terms

$$E_1^{p,q}(A(F)) = H^{p+q}(A) \otimes V_p(F) \cong H^{p+q}(F) \otimes V_p(F) = E_1^{p,q}(B(F)) .$$

It follows that $H^i(B(F)) \cong H^i(A(F))$ for all $i \geq 0$, and it suffices to show that $H^*(A(F))$ is trivial. Therefore consider an element

$$f = \sum_{I=(i_1, \dots, i_m)} \sum_{J=(j_1, \dots, j_n)} \alpha_{I,J} \omega_{j_1} \wedge \dots \wedge \omega_{j_n} [\omega_{i_1} | \dots | \omega_{i_m}] \in A \otimes V_m(F) ,$$

such that $df = 0$. This implies that

$$\sum_{i_1, J} \alpha_{I,J} \omega_{j_1} \wedge \dots \wedge \omega_{j_n} \wedge \omega_{i_1} = 0 \quad \text{for all } i_2, \dots, i_m .$$

Because A is quadratic, this expression (viewed in the tensor algebra T) decomposes as a sum of relations of the form $w_1 q^l w_2$, where $w_1, w_2 \in T$. If w_2 is of degree $\neq 0$ in T , the corresponding relation is already zero in f . We deduce that f is a sum of terms

$$\sum_{I=(i_2, \dots, i_m)} \sum_{l=1}^t \sum_{i,j} \lambda_{ij}^l \omega_{I,l} \wedge \omega_i [\omega_j | \omega_{i_1} | \dots | \omega_{i_m}] ,$$

where $\omega_{I,l} \in A$. Each such expression has a primitive

$$\sum_{I=(i_2, \dots, i_m)} \sum_{l=1}^t \sum_{i,j} \omega_{I,l} \lambda_{ij}^l [\omega_i | \omega_j | \omega_{i_1} | \dots | \omega_{i_m}] .$$

This is integrable: it maps to 0 under \wedge_k for $k \geq 2$, because f is integrable, and it maps to 0 under \wedge_1 because of the quadratic relations (9.1). It follows that every element $f \in A(F)$ of weight ≥ 1 such that $df = 0$ has a primitive. It is easy to write down a primitive of any element of weight 0. Thus $H^i(A(F)) = 0$ for all $i \geq 1$, which completes the proof of the theorem. \square

10. BIBLIOGRAPHY

- [An] Y. André, *Une introduction aux motifs*, Panoramas et Synthèses **17**, S.M.F., Paris (2004)
- [Ao1] K. Aomoto, *Fonctions hyperlogarithmes et groupes de monodromie unipotents*, Journal Fac. Sci. Tokyo, **25** (1978), 149-156.
- [Ao2] K. Aomoto, *Addition theorem of Abel type for hyperlogarithms*, Nagoya Math. Journal, **88** (1982), 55-71.

- [Ao3] K. Aomoto, *Special values of hyperlogarithms and linear difference schemes*, Illinois J. Math. **34**, no. 2 (1990), 191-216.
- [Ar] V. I. Arnold, *The cohomology ring of the coloured braid group*, Mat. Zametki **5** (1969), 227-231; Math Notes **5** (1969), 138-140.
- [B] A. Beauville, *Monodromie des systèmes différentiels linéaires à pôles simples sur la sphère de Riemann*, Sémin. Bourbaki, (1992-93), no. 765.
- [Be] F. Beukers, *A note on the irrationality of $\zeta(2)$ and $\zeta(3)$* , Bull. London Math. Soc **11**, (1979), 268-272.
- [BM] L. Boutet de Monvel, *Polylogarithmes*, www.math.jussieu.fr/~boutet.
- [B-S] A. Borel, J. P. Serre, *Corners and arithmetic groups*, and appendix: A. Douady, L. Hérault, *Arrondissement des variétés à coins*, Comment Math. Helv. **48** (1973), 436-491.
- [Bou] N. Bourbaki, *Algèbre*, Hermann, Paris.
- [Bri] E. Brieskorn, *Sur les groupes des tresses*, in Sémin. Bourbaki 1971/2, Lecture Notes in Math. **317**, Springer-Verlag (1973), 21-44.
- [Br1] F. C. S. Brown, *Polylogarithmes multiples uniformes en une variable*, C. R. Acad. Sci. Paris, Ser. I **338** (2004), 527-532.
- [Br2] F. C. S. Brown, *Single-valued hyperlogarithms and unipotent differential equations*, preprint.
- [Br3] F. C. S. Brown, *Périodes des espaces des modules $\overline{\mathfrak{M}}_{0,n}$ et valeurs zêta multiples*, to appear in C. R. Acad. Sci. Paris, (2006).
- [Ca1] P. Cartier, *Développements récents sur les groupes des tresses*, Sémin. Bourbaki, 1989-90, No. 716, Astérisque (1989), 17-67.
- [Ca2] P. Cartier, *Fonctions polylogarithmes, nombres polyzêtas et groupes pro-unipotents*, Séminaire Bourbaki, (2000-01), no. 885.
- [Ch1] K. T. Chen, *Iterated path integrals*, Bull. Amer. Math. Soc. **83**, (1977), 831-879.
- [Ch2] K. T. Chen, *Extension of C^∞ Function Algebra by Integrals and Malcev completion of π_1^** , Adv. in Math. **23**, no. 2 (1977), 181-210.
- [dC-P] C. De Concini, C. Procesi, *Wonderful models of subspace arrangements.*, Sel. Math., New Ser. 1, **3** (1995), 459-494.
- [De1] P. Deligne, *Le groupe fondamental de la droite projective moins trois points*, in ‘Galois groups over \mathbb{Q} ’, Proc. Workshop, Berkeley/CA (1987), Publ. Math. Sci. Res. Inst. **16** (1989), 79-297.
- [De2] P. Deligne, *Les immeubles des groupes de tresses généralisés*, Invent. Math. **17** (1972), 273-302.
- [De3] P. Deligne, *Equations différentielles à points singuliers réguliers*, Lecture Notes in Math. **163**, Springer-Verlag (1970).
- [De4] P. Deligne, *Théorie de Hodge III*, Publications Mathématiques de l’IHÉS, **44** (1974), 5-77
- [D-M] P. Deligne, D. Mumford, *The irreducibility of the space of curves of a given genus*, Publ. Math. IHES **36**, (1969), 75-109.
- [D-G] Deligne, P., Goncharov, A.B.: *Groupes fondamentaux motiviques de Tate mixte*, Ann. Sci. Ecole Norm. Sup., Sér. IV **38**, No. 1, (2005), 1-56.
- [Dev1] S. Devadoss, *Tesselations of moduli spaces and the mosaic operad*, in Contemp. Math. **239** (1999), 91-114.
- [Dev2] S. Devadoss, *Real compactification of Moduli spaces*, Notices of the A.M.S **51**, No.6 (2004), 620-628.

- [Di] A. C. Dixon, On a certain double integral, Proc. London Math. Soc. **2**, no.2 (1905), 8-15.
- [Dr] V. G. Drinfeld, *On quasitriangular quasi-Hopf algebras and on a group that is closely connected with $\text{Gal}(\overline{\mathbb{Q}}/\mathbb{Q})$* , Leningrad Math. Journal **2** (1991), No. 4, 829-860.
- [E] J. Ecalle, *Singularités non abordables par la géométrie*, Ann. Inst. Fourier, Grenoble, **42**, 1-2 (1992), 73-164.
- [F-R] M. Falk, R. Randell, *The lower central series of a fiber-type arrangement*, Invent. Math. **82** (1985), 77-88.
- [Fi1] S. Fischler, *Irrationalité de valeurs de zêta [d'après Apéry, Rivoal,..]*, Séminaire Bourbaki 2002-2003, Exposé 910, Astérisque (2002).
- [Fi2] S. Fischler, *Groupes de Rhin-Viola et intégrales multiples*, J. Théorie des Nombres de Bordeaux **15**, (2003), 479-534.
- [G-G-L] H. Gangl, A. B. Goncharov, A. Levin, *Multiple polylogarithms, polygons, trees and algebraic cycles*, preprint (2005) [arXiv:math.NT/0508066](https://arxiv.org/abs/math/0508066).
- [Ge] E. Getzler, *Operads and moduli spaces of genus 0 Riemann surfaces*, Prog. Math **129** (1995), 199-230.
- [Go1] A. B. Goncharov, *Multiple polylogarithms and mixed Tate motives*, preprint (2001), [arXiv:math.AG/0103059v4](https://arxiv.org/abs/math/0103059v4).
- [Go2] A. B. Goncharov, *Periods and mixed motives*, [arXiv:math.AG/0202154](https://arxiv.org/abs/math/0202154) (2001).
- [Go3] A. B. Goncharov, *Multiple ζ -values, Galois groups and the geometry of modular varieties*, Proceedings of the third European Congress of Mathematics, (2000).
- [Go4] A. B. Goncharov, *The dihedral Lie algebras and Galois symmetries of $\pi_1^{(l)}(\mathbb{P}^1 - (\{0, 1\} \cup \mu_N))$* , Duke Math. J. **110**, No. 3, (2001), 397-487.
- [G-M] A. B. Goncharov, Y. I. Manin, *Multiple ζ -motives and moduli spaces $\overline{\mathcal{M}}_{0,n}$* , Compositio Math. **140** (2004), 1-14.
- [GL] J. Gonzalez-Lorca, *Série de Drinfel'd, monodromie et algèbres de Hecke*, Thesis, Ecole Normale Supérieure, (1998).
- [G-S] P. Griffiths, W. Schmid, *Recent developments in Hodge theory*, in 'Discrete subgroups of Lie groups and applications to moduli', Internat. Colloq. Bombay 1973, Oxford Univ. Press (1975), 31-127.
- [Gr] A. Grothendieck, *On the de Rham cohomology of algebraic varieties*, Publ. Math. IHES **29** (1966), 95-103.
- [Ha1] R. M. Hain, *The geometry of the Mixed Hodge Structure on the Fundamental Group*, Proc. Sympos. in Pure Math. **46**, (1987), 247-282.
- [Ha2] R. M. Hain, *Classical Polylogarithms*, Proc. Sympos. Pure Math. **55**, (1994), Part 2.
- [H-M] R. M. Hain, R. MacPherson, *Higher logarithms*, Illinois J. Math. **34**, No. 2 (1990), 392-475.
- [H-Z1] R. M. Hain, S. Zucker, *A guide to unipotent variations of Mixed Hodge structures*, Lecture Notes in Math. **1246**, Springer (1987), 92-106.
- [H-Z2] R. M. Hain, S. Zucker, *Unipotent variations of Mixed Hodge structure*, Invent. Math **88**, no. 1 (1987), 83-124.
- [H-P-V] M. Hoang Ngoc, M. Petitot, J. Van Den Hoeven, *Polylogarithms and shuffle algebra*, FPSAC '98, Toronto, Canada, (June 1998).

- [Ho] M. E. Hoffman, *Quasi-shuffle products*, J. Algebraic Combin. **11**, 1 (2000), 49-68.
- [Ih] Y. Ihara, *Profinite braid groups, Galois representations, and complex multiplication*, Ann. of Math. **123** (1986), 3-106.
- [Ka] M. M. Kapranov, *The permutoassociahedron, MacLane's coherence theorem and asymptotic zones for the KZ equation*, Journal of Pure and Applied Algebra **85**, (1993), 119-142.
- [Ke] S. Keel, *Intersection theory of moduli space of stable N -point curves of genus zero*, Trans. AMS **330**, no.2 (1992), 545-574.
- [Kh] T. Kohno, *Bar complex of the Orlik-Solomon algebra*, Topology and its applications **118**, (2002) 147-157.
- [Kh2] T. Kohno, *Série de Poincaré-Koszul associée aux groupes de tresses pures*, Invent. Math. **82** (1985), 57-75.
- [Ko] E. R. Kolchin, *Differential algebra and Algebraic groups*, Academic Press, New York (1976).
- [Ku] E. E. Kummer, *Über die Transcendenten, welche aus wiederholten Integrationen rationaler Formeln entstehen*, J. Reine Angew. Mathematik, **21**, (1840), 74-90, 193-225, 328-371.
- [K-Z] V. G. Knizhnik, A. B. Zamolodchikov, *Current algebras and Wess-Zumino models in two dimensions*, Nucl. Phys. B **247** (1984), 83-103.
- [Kn] F. F. Knudsen, *The projectivity of the moduli space of stable curves II. The stacks $\overline{M}_{0,n}$* , Math. Scand. **52** (1983), 163-199.
- [Ko-Za] M. Kontsevich, D. Zagier, *Periods*, dans Mathematics unlimited - 2001 and beyond, Ed. Engquist and Schmidt, pp. 771-808, Springer, 2001.
- [LD] I. Lappo-Danilevskii, *Mémoires sur la théorie des systèmes des équations différentielles linéaires*, Chelsea, New York (1953).
- [Lee] C. Lee, *The associahedron and triangulations of the n -gon*, European Journal of Combinatorics **10** (1989), 551-560.
- [Le] *Structural Properties of Polylogarithms*, ed. L. Lewin, Math. surveys and monographs **37**, AMS (1991).
- [Le-M] T. Q. T. Le, J. Murakami, *Kontsevich's integral for the Kauffman polynomial*, Nagoya Math. Journal **142**, (1996) 39-65.
- [Ma] A. Magid, *Lectures on Differential Galois Theory*, Univ. Lecture Series **7** (1994).
- [Man] Y. Manin, *Frobenius manifolds, quantum cohomology, and moduli spaces*, AMS Colloquium Publications **47**, Providence, RI (1999).
- [Oe] J. Oesterlé, *Polylogarithmes*, Sémin. Bourbaki 1992-93, exp. no. 762, Astérisque **216** (1993), 49-67.
- [O-S] P. Orlick, L. Solomon, *Combinatorics and topology of complements of hyperplanes*, Invent. Math. **56**, (1980), 167-189.
- [O-T] P. Orlick, H. Terao, *Arrangements of hyperplanes*, Grundlehren der Math. Wiss. **300**, Springer-Verlag (1992).
- [Po] H. Poincaré, *Sur les groupes d'équations linéaires*, Acta Mathematica **4**, (1884).
- [Ra] G. Racinet, *Double shuffles of multiple polylogarithms at roots of unity*, Publ. Math. Inst. Hautes Etudes. Sci. **95**, 185-231 (2002).
- [Rad] D. E. Radford, *A natural ring basis for shuffle algebra and an application to group schemes*, Journal of Algebra **58**, (1979), 432-454.

- [Re] C. Reutenauer, *Free Lie Algebras*, London Math. Soc. Mono. **7**, Clarendon Press, Ox. Sci. Publ., (1993).
- [RV1] G. Rhin, C. Viola, *On a permutation group related to $\zeta(2)$* , Acta. Arith. **77**, no. 1 (1996), 23-56.
- [RV2] G. Rhin, C. Viola, *The group structure for $\zeta(3)$* , Acta. Arith. **97**, no. 3 (2001), 269-293.
- [S-V] M. F. Singer, M. Van der Put, *Galois theory of linear differential equations*, Grundlehren der Math. Wiss. **328**, Springer (2003).
- [St] J. D. Stasheff, *Homotopy associativity of H -spaces I*, Trans. Amer. Math. Soc. **108** (1963), 275-292.
- [Ter] T. Terasoma, *Selberg integrals and multiple zeta values*, Compos. Math **133**, (2002), no. 1, 1-24.
- [V] C. Voisin, *Hodge theory and complex algebraic geometry II*, Cambridge Studies in Advanced Math. **77**, (2003).
- [W] M. Waldschmidt, *Valeurs zêtas multiples : une introduction*, J. Théorie des Nombres de Bordeaux **12** (2002), 581-595.
- [Yo] M. Yoshida, *Fuchsian differential equations*, Aspects of Mathematics E11, Braunschweig 1987.
- [Zh] J. Zhao, *Multiple polylogarithms: analytic continuation, monodromy, and variations of mixed Hodge structures*, in ‘Contemporary trends in algebraic geometry and algebraic topology’, Tianjin, China (2000), Nankai Tracts in Math. **5**, (2002) 167-193.
- [Zl] S. A. Zlobin, *Integrals expressible as linear forms in generalized polylogarithms*, Math. Zametki [Math. Notes] **71** (2002), 782-787 [711-716].
- [Zl2] S. A. Zlobin, *Properties of coefficients of certain linear forms in generalized polylogarithms*, preprint (2005), [arXiv:math.NT/0511245v1](https://arxiv.org/abs/math/0511245v1).
- [Zu] W. Zudilin, *Well-poised hypergeometric transformations of Euler-type multiple integrals*, J. London Math. Soc. **70**, no. 2 (2004), 215-230.

11. INDEX OF NOTATIONS

We list the most frequently used notations, along with the section in which they are first defined. The integers $n = \ell + 3$, where $\ell \geq 0$, are fixed.

Section 2:

- δ : A dihedral structure on a set S with n elements.
- $(\mathbb{P}^1)_*$: The set of n distinct points in the projective line.
- $\mathfrak{M}_{0,S}$: The moduli space of curves of genus 0 with points marked by S .
- $\mathfrak{M}_{0,S}^\delta$: The partial blow-up of $\mathfrak{M}_{0,S}$ with respect to δ .
- $\overline{\mathfrak{M}}_{0,S}$: The full blow-up of $\mathfrak{M}_{0,S}$.
- $\mathcal{O}(\mathfrak{M}_{0,S})$: The ring of regular functions on $\mathfrak{M}_{0,S}$.
- $\chi_{S,\delta}$: The set of all chords in the n -gon (S, δ) .
- $\chi_{S,\delta}^k$: The set of all partial k -triangulations of (S, δ) .
- $\{i, j\} \sim_x \{k, l\}$: The chords $\{i, j\}, \{k, l\} \in \chi_{S,\delta}$ cross.
- $\{u_{ij} : \{i, j\} \in \chi_{S,\delta}\}$: The set of dihedral coordinates on $\mathfrak{M}_{0,S}$.
- (x_1, \dots, x_ℓ) : The set of cubical coordinates on $\mathfrak{M}_{0,S}$.
- (t_1, \dots, t_ℓ) : The set of simplicial coordinates on $\mathfrak{M}_{0,S}$.
- $(x_1^\alpha, \dots, x_\ell^\alpha)$: The set of vertex coordinates corresponding to $\alpha \in \chi_{S,\delta}^\ell$.
- $X_{S,\delta}$: The open associahedron $X_{S,\delta} \subset \mathfrak{M}_{0,S}(\mathbb{R})$.
- $\overline{X}_{S,\delta}$: The closed associahedron $\overline{X}_{S,\delta} \subset \mathfrak{M}_{0,S}^\delta(\mathbb{R})$.
- F_{ij} : The face of $\overline{X}_{S,\delta}$ corresponding to the chord $\{i, j\} \in \chi_{S,\delta}$.
- F_α : The intersection of faces $\bigcap_{\{i,j\} \in \alpha} F_{ij}$ corresponding to $\alpha \in \chi_{S,\delta}^k$.
- f_T : The forgetful map $f_T : \mathfrak{M}_{0,S} \rightarrow \mathfrak{M}_{0,T}$.
- m_\square : The cubical multiplication map.
- m_Δ : The simplicial multiplication map.

Section 3:

- A : An alphabet.
- $\mathbb{Z}\langle A \rangle$: The free tensor algebra on A .
- $\#$: The shuffle product.
- Δ : The coproduct on the shuffle algebra.
- ε : The counit on the shuffle algebra.
- ∂_α : The operator acting by truncation on the left.
- $M = \mathbb{A}^\ell \setminus \bigcup_{i=1}^N H_i$: The complement of an affine hyperplane arrangement.
- \mathcal{O}_M : The ring of regular functions on M .
- $B(\mathcal{O}_M) = B(M)$: The reduced bar construction on M .
- $B_{\mathcal{O}_{M'}}(E)$: The relative bar construction on E with coefficients in $\mathcal{O}_{M'}$.
- $k\{\epsilon_1, \dots, \epsilon_\ell\}$: The differential k -algebra of Laurent series in $\epsilon_1, \dots, \epsilon_\ell$.
- $U\{\epsilon_1, \dots, \epsilon_\ell\}$: The differential k -algebra of logarithmic Laurent series.
- $\mathbf{up}(R, \varepsilon)$: The category of unipotent pointed extensions of (R, ε) .
- $\mathbf{ut}(R, p)$: The category of unipotent pointed extensions of (R, p) , where p is a base point at infinity.
- $U_{\widehat{R}/R}$: The relative unipotent closure with respect to a one-dimensional fibration $R \rightarrow \widehat{R}$.

Section 4:

- $U_{p,q}$: The open real complement of the coordinate hyperplanes in $\mathbb{R}^p \times \mathbb{R}_+^q$.
- $V_{p,q}$: The open complex complement of q coordinate hyperplanes in \mathbb{C}^{p+q} .
- \mathcal{F}^{an} : The sheaf of analytic functions.

- \mathcal{F}^{\log} : The sheaf of analytic functions with logarithmic singularities.
 \mathcal{F}_p^{\log} : The sheaf of analytic functions with ordinary and logarithmic poles.

Section 5:

- Σ : A set of points $\{\sigma_0, \dots, \sigma_N\} \subset \mathbb{P}^1$.
 \mathcal{O}_Σ : The ring of regular functions on $\mathbb{P}^1 \setminus \Sigma$.

Section 6:

- \mathbb{C}_*^{n-1} : The configuration space of $n-1$ distinct points in \mathbb{C} .
 Δ_{ij} : Logarithmic 1-forms $\Delta_{ij} = d \log(z_i - z_j)$ on $(\mathbb{P}^1)_*^n$.
 t_{ij} : Generators of the infinitesimal braid algebra, where $1 \leq i \leq j \leq n$.
 Ω_{KZ} : The Knizhnik-Zamolodchikov 1-form on $(\mathbb{P}^1)_*^n$.
 δ_{ij} : Infinitesimal dihedral braid elements, indexed by $\{i, j\} \in \chi_{S, \delta}$.
 ω_{ij} : Logarithmic 1-forms $\omega_{ij} = d \log u_{ij}$.
 $\Omega_{S, \delta}$: The canonical dihedral 1-form on $\mathfrak{M}_{0, S}$.
 $\mathfrak{B}_{S, \delta}$: The dihedral braid algebra.
 $\widehat{\mathfrak{B}}_{S, \delta}$: The completion of the dihedral braid algebra.
 V^δ : The set of vertices of the associahedron $\overline{X}_{S, \delta}$.
 $L_{v, \delta}$: The generating series of polylogarithms on $\mathfrak{M}_{0, S}$.
 $L^{v, \delta}(\mathfrak{M}_{0, s})$: The $\mathbb{Q}(\mathfrak{M}_{0, S})$ -algebra of polylogarithms on $\mathfrak{M}_{0, S}$ whose regularised value at the vertex $v \in V^\delta$ is zero.
 $\rho_{v, \delta}$: The realisation isomorphism $\rho_{v, \delta} : B(\mathfrak{M}_{0, S}) \rightarrow L^{v, \delta}(\mathfrak{M}_{0, S})$.
 \mathcal{Z} : The ring $\mathbb{Q}[\zeta(2), \zeta(3), \dots]$ generated by all multiple zeta values.

Section 7:

- $\omega_{S, \delta}$: The canonical volume form on $\mathfrak{M}_{0, S}(\mathbb{R})$.
 $I_{S, \delta}(\alpha_{ij})$: The period integral over $X_{S, \delta}$.
 $m_{S, \delta}(\omega)$: The framed mixed Tate motive defined by ω .
 $\Omega(\underline{\epsilon})$: The multiple zeta volume form.
 $L_{\mathcal{Z}}^\delta(\mathfrak{M}_{0, S})$: The algebra of polylogarithms on $\mathfrak{M}_{0, S}$ with \mathcal{Z} coefficients.
 $L_{\mathcal{Z}}^{\delta, +}(\mathfrak{M}_{0, S})$: The subalgebra of polylogarithms with no poles along $\partial X_{S, \delta}$.

45 RUE D'ULM

E-mail address: brown@clipper.ens.fr