



HAL
open science

Evaluation of Customer-Oriented Power Supply Risk with Distributed PV-Storage Energy Systems

Mike Brian Ndawula, Antonio de Paola, Ignacio Hernando-Gil

► **To cite this version:**

Mike Brian Ndawula, Antonio de Paola, Ignacio Hernando-Gil. Evaluation of Customer-Oriented Power Supply Risk with Distributed PV-Storage Energy Systems. Risk Day 2019 - EPSRC Supergen Energy Networks Hub, Mar 2019, Cambridge, United Kingdom. hal-02446319

HAL Id: hal-02446319

<https://hal.science/hal-02446319>

Submitted on 20 Jan 2020

HAL is a multi-disciplinary open access archive for the deposit and dissemination of scientific research documents, whether they are published or not. The documents may come from teaching and research institutions in France or abroad, or from public or private research centers.

L'archive ouverte pluridisciplinaire **HAL**, est destinée au dépôt et à la diffusion de documents scientifiques de niveau recherche, publiés ou non, émanant des établissements d'enseignement et de recherche français ou étrangers, des laboratoires publics ou privés.

Evaluation of Customer-Oriented Power Supply Risk with Distributed PV-Storage Energy Systems

Mike Brian Ndawula¹, Antonio De Paola¹, Ignacio Hernando Gil²

Customer Priorities in a Climate of Rising Energy Prices

- **Accurate** reliability evaluation raises customer WTP.
- **System-oriented** evaluation masks poor reliability performance.
- Different customer **perceptions** of DNO services' value.

Perception of the DNO's 18% share of the electricity bill

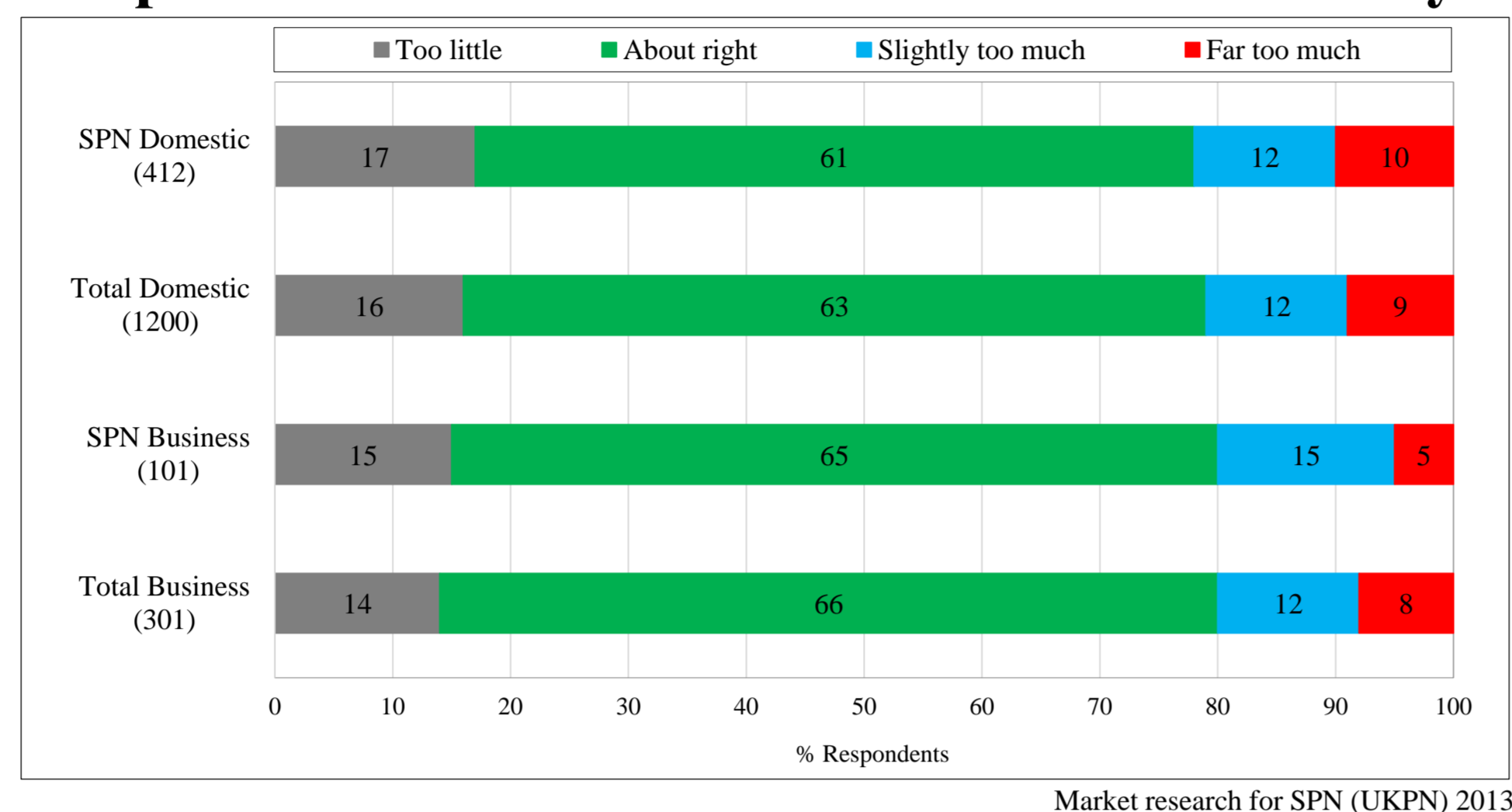

DNO services valued most highly are;

- **Rapid supply restoration.**
- **Quicker detection** of supply loss.
- **Carbon reduction** initiatives.

Customer WTP for increases in DNO service levels

Service Levels	WTP in % in 2023*	
	Domestic	Business
Cheaper and quicker connection of low carbon electricity generators	2.90	2.34
Investments enabling quicker detection of loss of supply	2.89	3.01
Investments supporting uptake of micro-generation technologies	1.96	1.94
Time to restore 80% of affected rural customers within 1 hour	1.30	1.33
Time to restore 80% of affected urban customers within 1 hour	-1.24	-1.37

*SPN 2013; WTP = Willingness to Pay

Integrated Quality of Supply Analysis

Urban MV Network

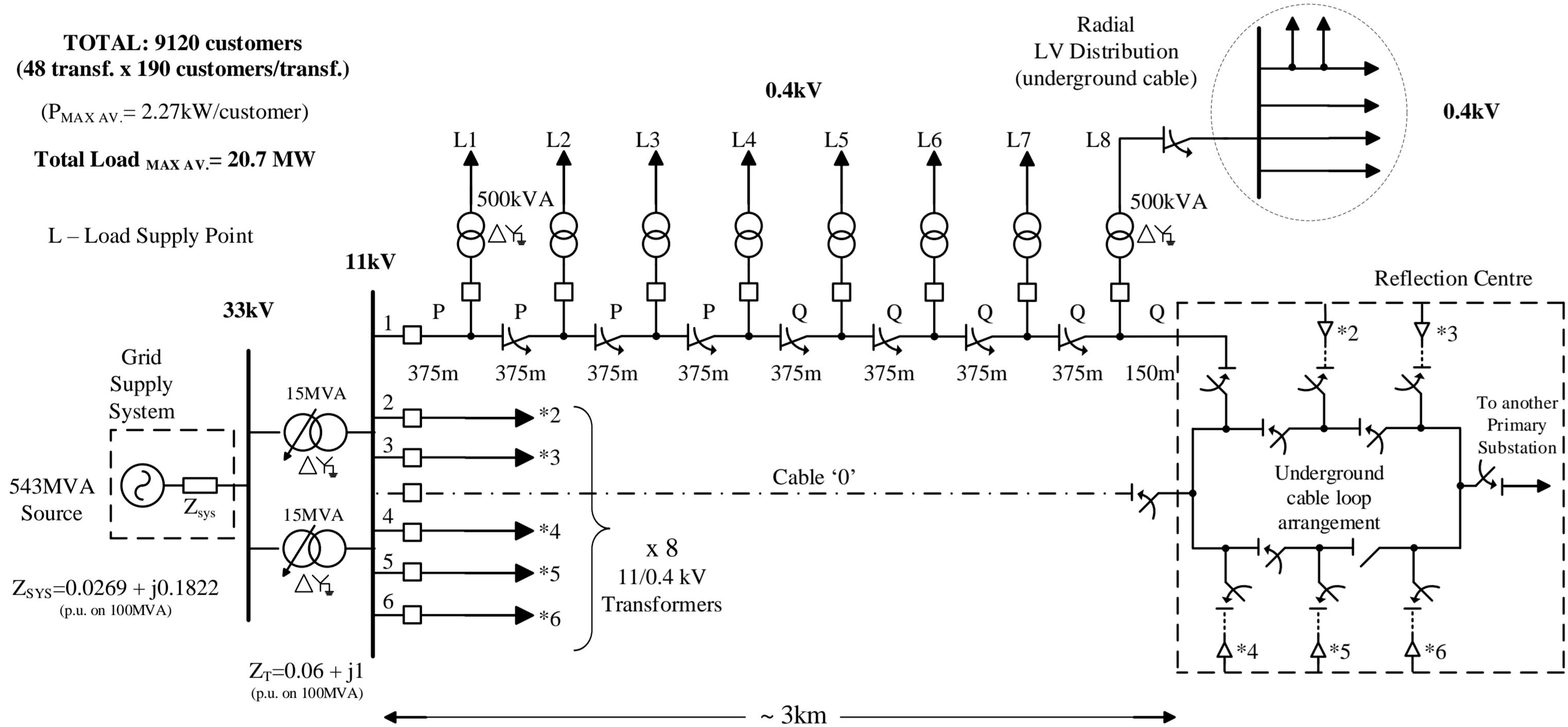

- After Diversity Maximum Demand: 2.27kW/customer

- LV aggregate networks with reliability equivalents

Monte-Carlo simulation enhanced by including:

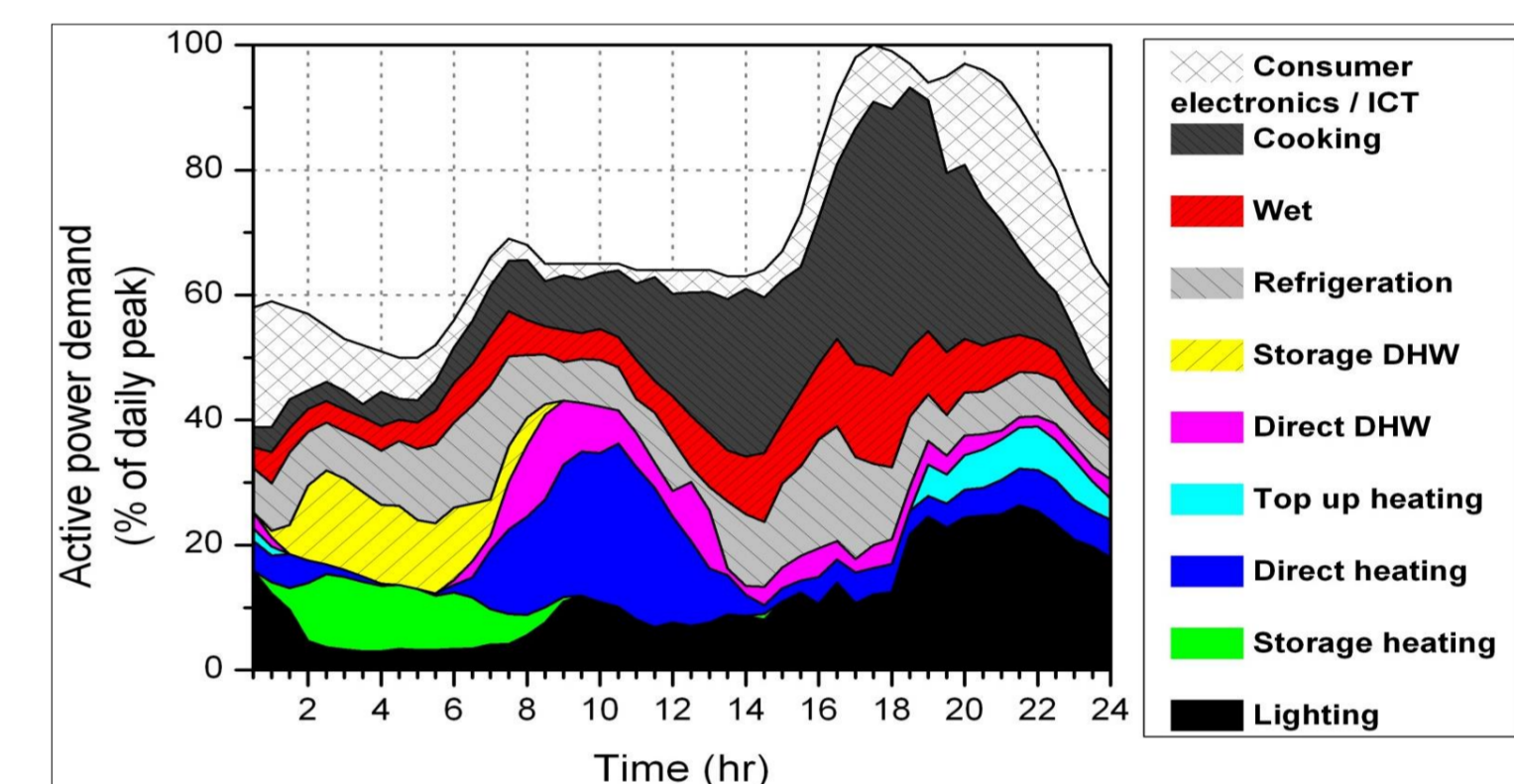
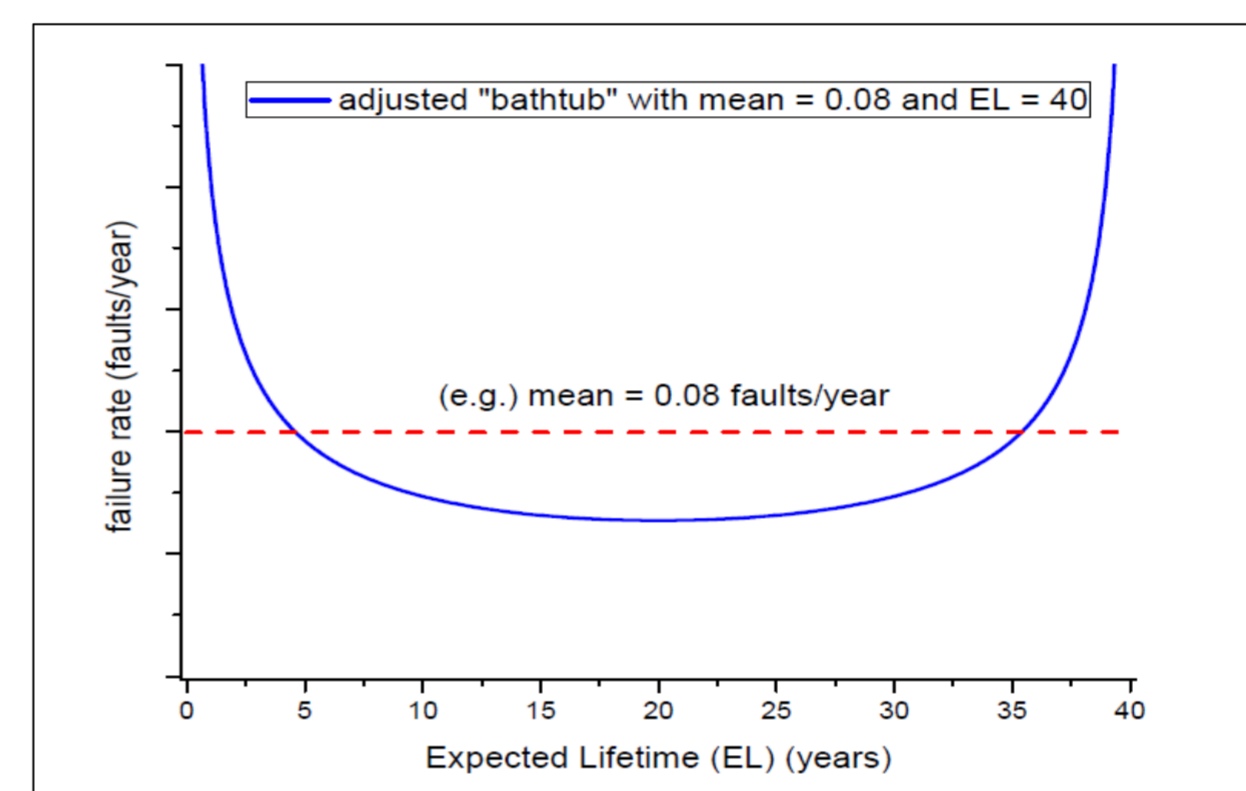

- Time-varying component failure rates.

- Time-varying demand profiles.

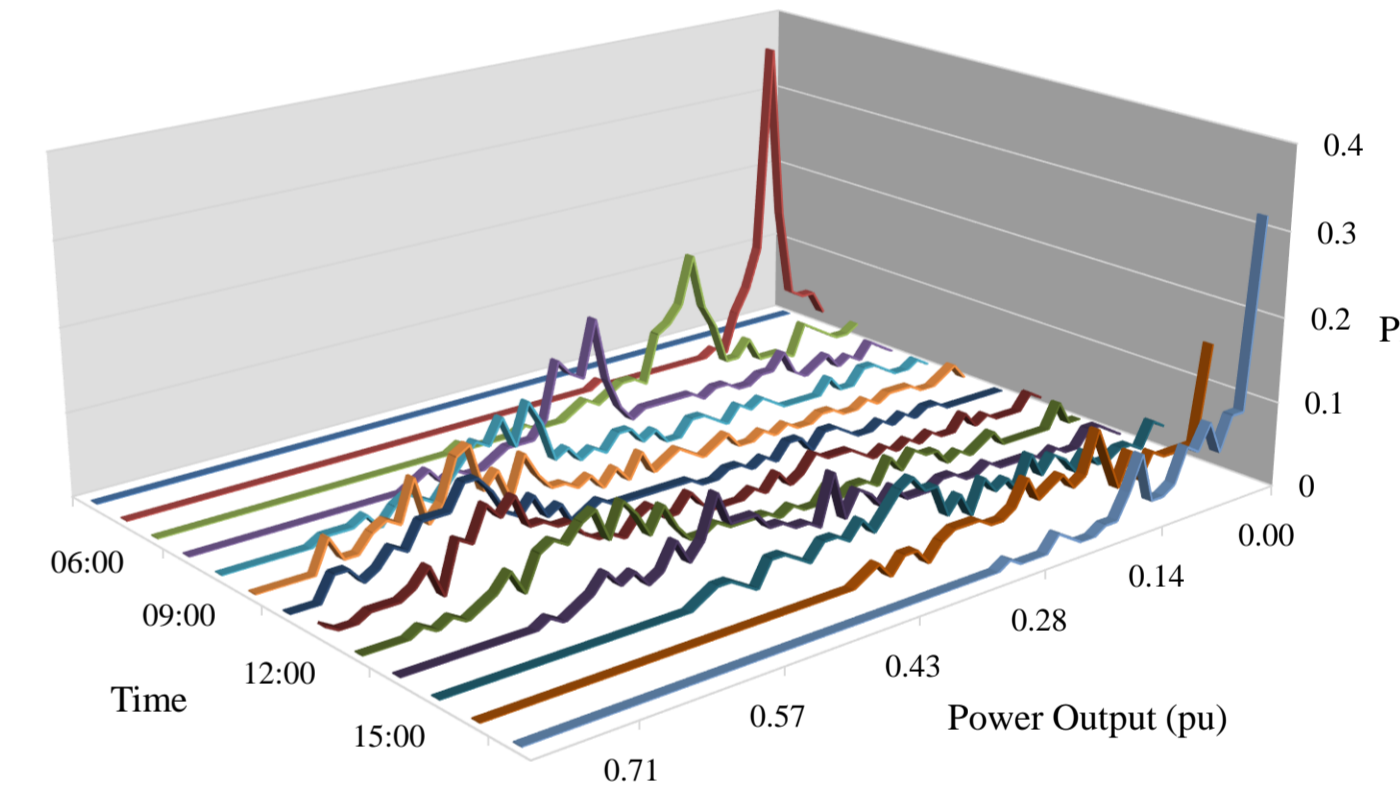
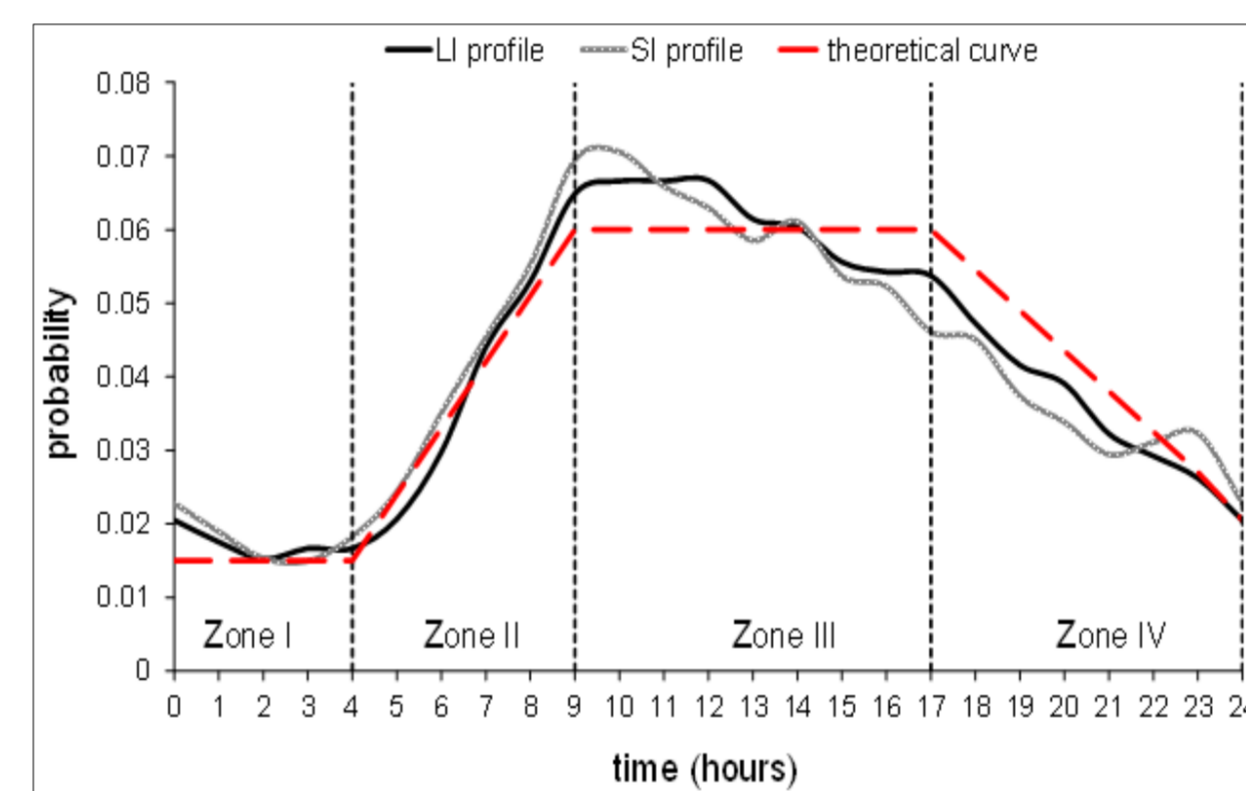

- Daily probabilities of long/short interruptions.

- Spatial-temporal variation of PV.

Customer-Oriented Reliability Evaluation

Reliability Enhancement

1) **PV+DSR** - Uncontrolled solar photovoltaic (PV) energy with a 50% overall network penetration, and demand-side response (DSR) designed for reliability improvement through load reductions during periods with high fault-probability.

2) **ES + DSR** – Energy Storage (ES) where daily Microgeneration output is controlled by an energy management system to provide a backup capability of 3.67 kWh per customer per fault, coupled with DSR.

Comprehensive Reliability Assessment

- Each customer index is significantly larger than its system equivalent.
- ES+DSR significantly alleviates impacts of long interruptions but
- Has negligible impact on short interruptions.

Parameter	Index	Base Case	PV+DSR	ES+DSR
Duration of Long Interruptions	CAIDI (hours/aff. cust.)	3.678	2.751	6.243
	SAIDI (hours/cust./year)	0.550	0.407	0.282
Frequency of Long Interruptions	CAIFI (ints/aff. cust.)	0.720	0.720	0.557
	SAIFI (ints/cust./year)	0.157	0.157	0.039
Frequency of Short Interruptions	CAMIFI (ints/aff. cust.)	0.797	0.797	0.819
	MAIFI (ints/cust./year)	0.208	0.208	0.216
Energy not supplied	ACCI (kWh/aff. cust.)	1090.41	828.99	1790.79
	ENS (kWh/cust./year)	146.37	110.63	85.21

aff. cust. = affected customer; int = interruption

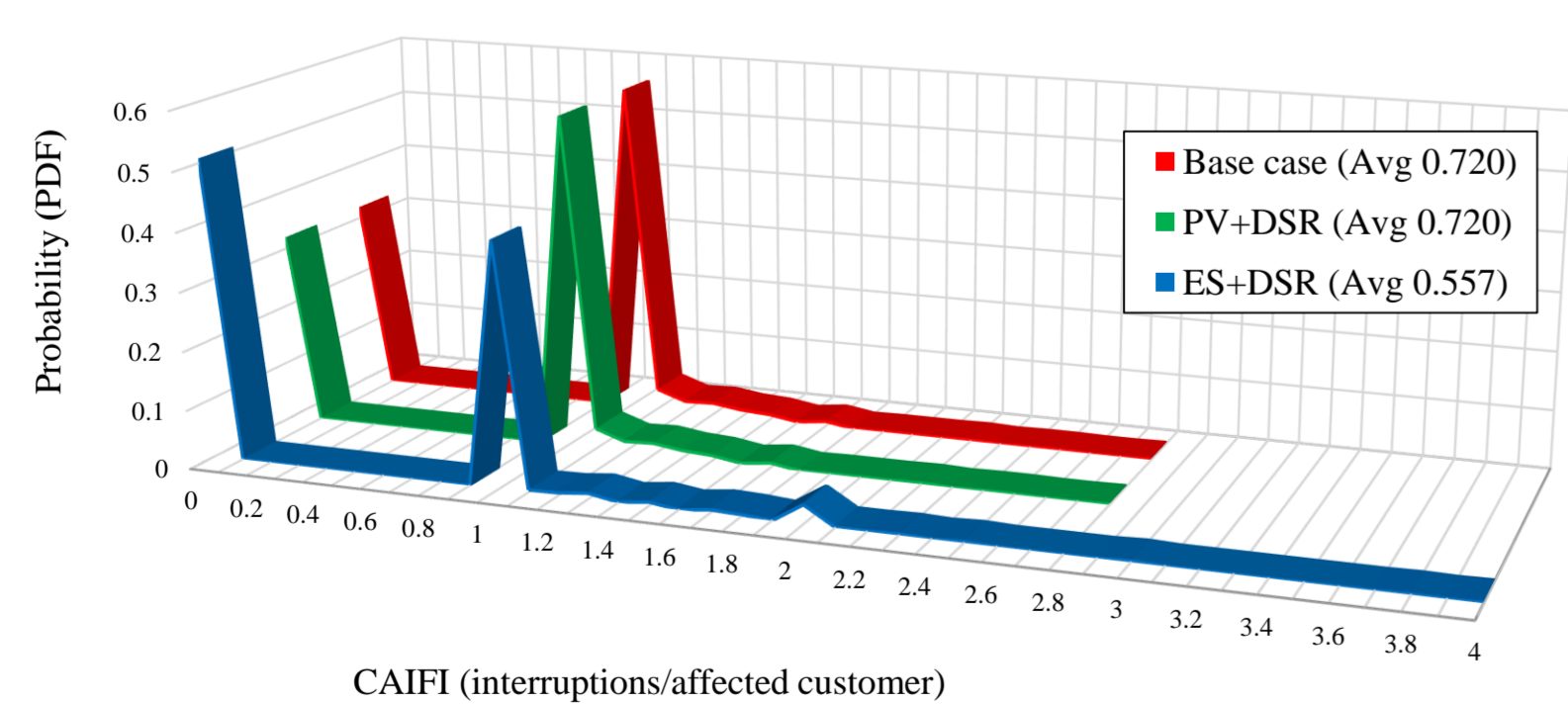

Impact of the frequency of long interruptions.

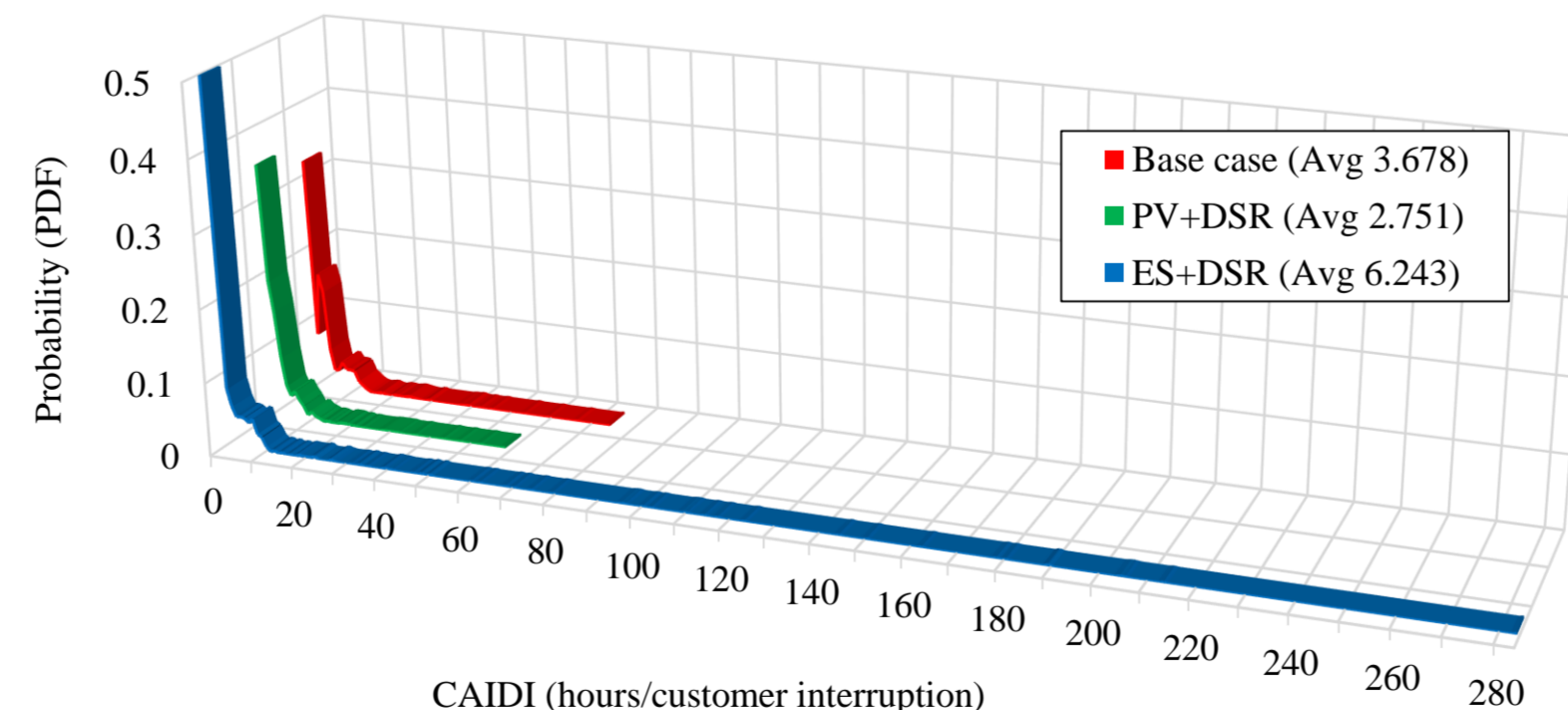

Impact of the duration of long interruptions.

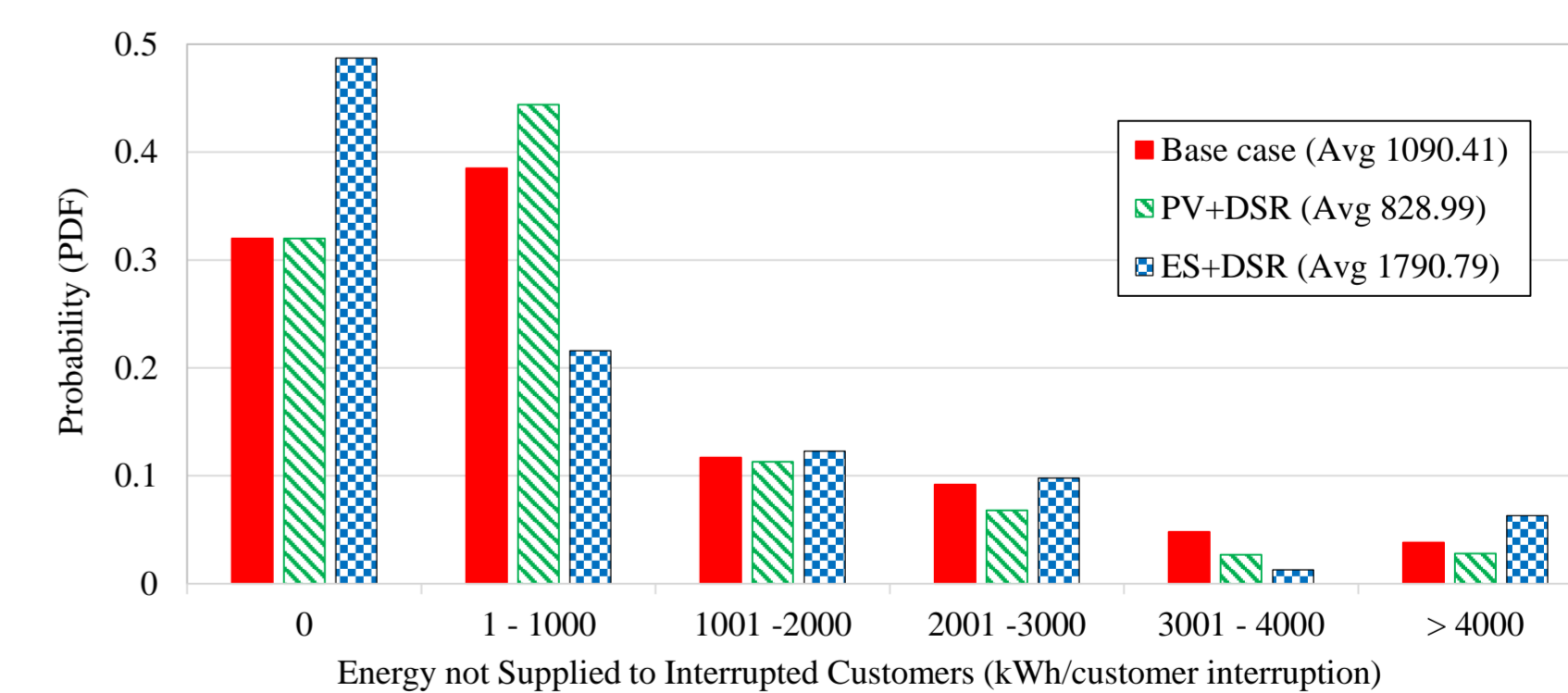

Probability of ENS to interrupted customers.

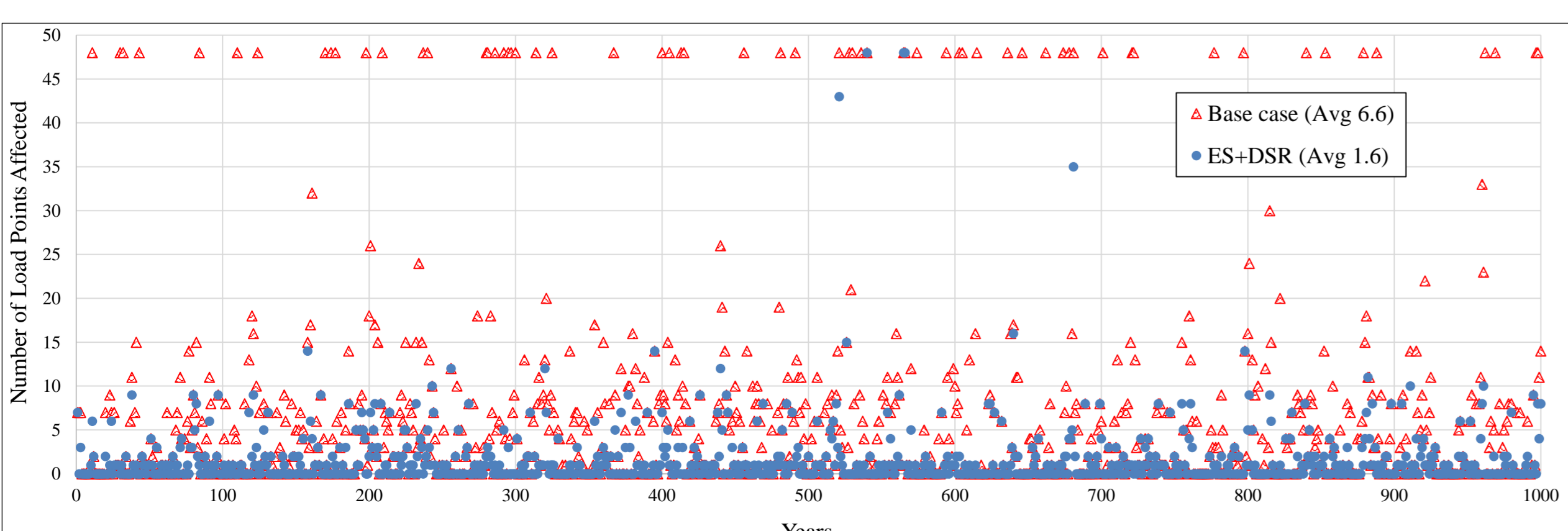

Number of network load points affected by supply interruptions.

- **PV-storage** systems offer **reductions** in the average frequency and duration of interruptions, number of affected load points, and the subsequent ENS.
- **Customer WTP** is enhanced by customer-oriented reliability evaluation through:
 - More accurate quantification of perceived customer reliability.
 - Confidence in DNO-reporting on power delivery.
 - Supporting the uptake of distributed energy resources e.g. PV.
- **Reliability-based customer identification** enables DNOs to effect impactful network improvements, and consistently exceed regulator-set performance targets.

¹ M.B.Ndawula@bath.ac.uk, A.De.Paola@bath.ac.uk, Centre for Sustainable Power Distribution, University of Bath.

² I.Hernandogil@estia.fr, ESTIA Institute of Technology, University of Bordeaux.